

OGGETTO DELL'OPERA

L'opera prevede la realizzazione dell'impianto di illuminazione esterna al servizio di un nuovo fabbricato commerciale – punto vendita Bricoman e di alcune strade motorizzate e aree verdi adiacenti che saranno cedute al comune di Venezia.

L'obiettivo principale di questo intervento è quello di illuminare le aree esterne al fine di garantire:

- la riduzione dell'inquinamento luminoso;
- il risparmio energetico;
- la sicurezza del traffico, delle persone e del territorio;
- il miglioramento della viabilità;

Con questo progetto si intende ottenere i seguenti benefici:

ECONOMICI

- risparmi di energia;
- risparmi di gestione e manutenzione;
- crescita economica e culturale della cittadina, migliorando la fruizione notturna degli spazi urbani.

AMBIENTALE

- riduzione dell'inquinamento luminoso;
- minor consumo di combustibili fossili, grazie alla riduzione di CO₂;
- riduzione della produzione di rifiuti conferiti allo smaltimento grazie all'uso di sorgenti luminose "long-life" (LED).

I lavori comprendono:

- L'installazione di punti luce con corpi illuminanti a LED.
- Esecuzione di scavi, posa di plinti di fondazione e pozzetti di derivazione, posa di cavidotti interrati in tubo in PVC serie pesante a doppia parete, posa di pali.
- Il collegamento alle linee di alimentazione esistenti.

COMPETENZE ED ESCLUSIONI

L'esecuzione del lavoro verrà studiata per assicurare i necessari livelli, di illuminamento nel rispetto delle norme UNI e CEI relative a questo tipo di installazione. Il progetto, riguarda la realizzazione dell'illuminazione pubblica delle Vie Comunali e dell'area verde come evidenziato nelle planimetrie allegate.

L'impianto elettrico sarà realizzato in classe di isolamento II come di seguito descritto, con materiali ed apparecchi adatti all'ambiente in cui saranno installati pertanto i corpi illuminanti avranno classe di isolamento equivalente.

Per poter ottemperare alla Legge Regionale 17/09 il progetto illuminotecnico rispetta i requisiti imposti di illuminamento massimo a terra e nullo verso la volta celeste tuttavia in alcune aree esterne dell'edificio non sempre è stato possibile rispettare i livelli di uniformità indicati nella norma UNI 12464-2.

REQUISITI DELL'INTERVENTO

L'intervento proposto è rispondente ai seguenti requisiti:

- coerenza con la Legge regionale n.17 del 7 Agosto 2009 "Nuove norme per il contenimento dell'inquinamento luminoso, il risparmio energetico dell'illuminazione per esterni e per la tutela dell'ambiente e dell'attività svolta dagli osservatori astronomici";
- coerenza con la programmazione di settore vigente per gli interventi infrastrutturali;
- coerenza con il Piano Energetico Regionale – Fonti Rinnovabili – Risparmio Energetico – Efficienza Energetica;
- rispetto della normativa comunitaria, nazionale e regionale in materia paesaggistica ambientale;
- rispetto dei criteri previsti dal Decreto del Ministero dell'Ambiente e della Tutela del Territorio e del Mare, del 27 settembre 2017 "Criteri Ambientali Minimi (C.A.M.) per l'acquisizione di sorgenti luminose per illuminazione pubblica, l'acquisizione di apparecchi di illuminazione pubblica, l'affidamento del servizio di progettazione di impianti di illuminazione pubblica";
- rispetto delle disposizioni relative all'attuazione della direttiva comunitari a 92/43/CEE e D.P.R. 357/1997. Guida metodologica per la valutazione di incidenza. Procedure e modalità operative" (e successive modifiche e/o integrazioni).

AI PROGETTI

Via Peppino Impastato, 14 - 30174 Venezia Mestre
Tel +39 041 95 75 70 - Fax +39 041 97 60 20
info@ai-progetti.it - www.ai-progetti.it

C.F. - P. IVA: 03474500273
REA 311568
PEC aiprogetti@pec.it



LEGGI E NORME DI RIFERIMENTO

Gli impianti saranno realizzati a regola d'arte (Legge 186 del 01/03/68).

Le caratteristiche degli impianti stessi, nonché dei loro componenti dovranno corrispondere alla norma di legge e di regolamento vigenti alla data del contratto, inoltre il committente e l'appaltatore, ai sensi della D.lgs. 9 Aprile 2008 n. 81, dovranno cooperare al fine di mettere in atto le misure di prevenzione e protezione dai rischi sul lavoro.

Gli impianti dovranno essere conformi in particolare a:

➤	alle prescrizioni delle Autorità locali
➤	alle prescrizioni e indicazioni del Distributore
➤	alle prescrizioni e indicazioni della TIM S.p.a.
➤	alle prescrizioni e indicazioni di ARPAV
Legge 1° Marzo 1968, n. 186	Disposizioni concernenti la produzione di materiali, apparecchiature, macchinari, installazione e impianti elettrici ed elettronici
D.lgs 9 Aprile 2008 n.81	Attuazione dell'articolo 1 della legge 3 agosto 2007, n. 123, in materia di tutela della salute e della sicurezza nei luoghi di lavoro
UNI 11464-2	Luce e illuminazione - Illuminazione dei posti di lavoro - Parte 2: Posti di lavoro in esterno
UNI 11248:2016	Illuminazione stradale – Selezione delle categorie illuminotecniche
UNI EN 13201-2:2016 –	Illuminazione stradale – Parte 2: Requisiti prestazionali;
UNI EN 13201-3:2016 –	Illuminazione stradale – Parte 3: Calcolo delle prestazioni;
UNI EN 13201-4:2016	Illuminazione stradale – Parte 4: Metodi di misurazione delle prestazioni fotometriche;
UNI/TS 11726	Specifica tecnica illuminazione degli attraversamenti pedonali nelle strade con traffico motorizzato;
Legge regionale n.17 del 7 Agosto 2009	Nuove norme per il contenimento dell'inquinamento luminoso, il risparmio energetico nell'illuminazione per esterni e per la tutela dell'ambiente e dell'attività svolta dagli osservatori astronomici
CEI 64-8/7	Impianti di illuminazione situati all'esterno;
Norma CEI 64-8	"Impianti elettrici utilizzatori di bassa tensione";
Norme UNI-EN 40	Sostegni in acciaio per pali di pubblica illuminazione;

Seguendo le disposizioni legislative vigenti gli impianti dovranno mantenere il funzionamento completo anche nelle ore notturne, non ottenendo con lo spegnimento programmato i requisiti di uniformità richieste dalle Norme UNI.

AI PROGETTI

Via Peppino Impastato, 14 - 30174 Venezia Mestre
Tel +39 041 95 75 70 - Fax +39 041 97 60 20
info@ai-progetti.it - www.ai-progetti.it

C.F. - P. IVA: 03474500273
REA 311568
PEC aiprogetti@pec.it



CARATTERISTICHE DEL SISTEMA DI ALIMENTAZIONE PUBBLICA ILLUMINAZIONE

L'impianto di pubblica illuminazione delle strade motorizzate e delle aree verdi adiacenti, che saranno oggetto di cessione all'Amministrazione Comunale, sarà alimentato da un quadro elettrico dell'illuminazione pubblica esistente e non in oggetto.

Sistema di distribuzione:	TT
Classificazioni:	I Categoria
Tensione nominale d'esercizio del sistema	400 V
Tensione nominale verso terra del sistema	230 V

A fronte di ciò la consegna dell'energia da parte dell'ente erogatore, la quale si attesta al contatore di misura, è fornita con il sistema TT e il collegamento diretto a terra di un punto dell'impianto sarà garantito dall'ente fornitore stesso.

Si consiglia all'installatore di chiedere la presenza del manutentore comunale per le operazioni/manovre da effettuare sui quadri elettrici esistenti.

CARATTERISTICHE DEL SISTEMA DI ALIMENTAZIONE ILLUMINAZIONE ESTERNA EDIFICIO

L'edificio verrà alimentato in Media Tensione dalla rete di E-Distribuzione con N.1 Cabina di ricezione MT e in cascata N.1 Cabina di trasformazione MT/BT con N.2 trasformatori 20000/400 V da 630kVA. In parallelo all'impianto di distribuzione elettrica sarà collegato il generatore fotovoltaico tipo Grid-Connected della potenza di 214,80 kWp.

Sistema di distribuzione	TN-S
Classificazioni	I Categoria
Tensione nominale d'esercizio del sistema	400 V
Tensione nominale verso terra del sistema	230 V
Potenza Trasformatori MT/BT 1*	630 kVA
Potenza Trasformatore MT/BT 2*	630 kVA
Corrente di corto circuito presunta	30,4 kA
Potenza del generatore fotovoltaico	214,80 kWp

(*) I trasformatori MT/BT saranno eserciti in parallelo permanente sulla bassa tensione.

AI PROGETTI

Via Peppino Impastato, 14 - 30174 Venezia Mestre
Tel +39 041 95 75 70 - Fax +39 041 97 60 20
info@ai-progetti.it - www.ai-progetti.it

C.F. - P. IVA: 03474500273
REA 311568
PEC aiprogetti@pec.it



VANTAGGI TECNOLOGICI

I vantaggi conseguibili attraverso la sostituzione degli apparecchi di illuminazione attuali con apparecchi a LED si possono così riassumere:

- maggiore efficienza in termini di lumen/Watt (rendimento medio 135 lm/W), rispetto alle lampade a vapori di mercurio o comunque a bassa efficienza;
- possibilità di impiego di micro ottiche applicate alle sorgenti puntiformi LED, con riduzione (o quasi annullamento) del flusso disperso e quindi della potenza installata;
- utilizzo di alimentatori elettronici, con riduzione delle perdite di alimentazione di circa il 20%;
- possibilità di regolazione del flusso luminoso punto-punto, riducendone l'emissione nelle ore notturne di minor traffico, mantenendo l'uniformità dell'illuminazione del tratto stradale;
- unificazione delle tipologie di lampade installate, con possibilità di direzionare il flusso luminoso in modo da illuminare al meglio la strada e aumentare il comfort visivo (luce bianca con resa cromatica elevata);
- riduzione dei costi di gestione per manutenzioni in quanto i LED sono caratterizzati a una vita media molto più lunga (circa 100.000 ore), rispetto alle lampade tradizionali (8.000 ore per lampade ai vapori di sodio e ioduri metallici);
- riduzione dell'inquinamento luminoso mediante l'impiego di apparecchi di illuminazione dotati di ottiche che orientano il fascio luminoso esclusivamente verso il basso;
- accensione istantanea.

SISTEMI ADOTTATI PER IL RISPARMIO ENERGETICO

Al fine di ottenere un risparmio energetico sono stati adottati i seguenti sistemi:

1. Apparecchi di illuminazione equipaggiati con sorgenti a LED ad alta efficienza.
2. Apparecchi di illuminazione dotati di **reattore a dimmerazione automatica**.

Tale reattore permette di ridurre il consumo elettrico nelle ore notturne di minor traffico, periodo in cui entra in funzione il sistema di regolazione.

Questo sistema riduce i consumi elettrici, mantenendo accesi tutti gli apparecchi di illuminazione, in conformità alle vigenti, e garantendo il coefficiente di uniformità richiesto.

DIMENSIONAMENTO IMPIANTO DI PUBBLICA ILLUMINAZIONE STRADE MOTORIZZATE

PRESTAZIONI ILLUMINOTECNICHE

Nello studio dell'impianto è stata eseguita la verifica delle prestazioni illuminotecniche.

Ogni strada è stata classificata in base alla tipologia di servizio, e in base a questa classificazione, i calcoli sono stati realizzati al fine di garantire le prestazioni illuminotecniche richieste dalle Norme UNI 11248 e UNI EN 13201-2, calcolate nelle condizioni di funzionamento.

Riassumiamo la classificazione delle strade, ottenuta dalla Tavola 22 del Piano Generale del Traffico Urbano di Mestre e Marghera, sulla quale si è basata l'individuazione della categoria illuminotecnica di ingresso per l'analisi dei rischi:

Denominazione	Limiti di velocità	Classificazione	Portata max di servizio (veicoli/ora) UNI 11248	Portata di servizio (veicoli/ora) dichiarata	Categoria Illuminotecnica di ingresso UNI 11248
STRADE MOTORIZZATE	50 km/h	F Strade locali urbane	800	N.P.	M4

La classificazione delle strade è stata eseguita valutando la velocità di percorrenza, gli utenti primari e secondari, le condizioni atmosferiche, la densità di intersezioni, la difficoltà di guida e altri fattori enunciati dalle norme UNI EN 13201 e UNI11248 ottenendo le seguenti classificazioni:

SCelta DELLA CATEGORIA ILLUMINOTECNICA DI PROGETTO

Parametro di influenza	Riduzione massima della categoria illuminotecnica	Applicata SI / NO
Complessità del campo visivo normale	1	NO
Assenza o bassa densità delle zone di conflitto	1	NO
Segnaletica cospicua nelle zone conflittuali	1	NO
Segnaletica stradale attiva	1	NO
Pericolo di aggressione non segnalato	1	NO

SCelta DELLA CATEGORIA ILLUMINOTECNICA DI ESERCIZIO

Parametro di influenza	Riduzione massima della categoria illuminotecnica	Applicata SI / NO
Flusso del traffico <50% rispetto alla portata di servizio	1	SI*
Flusso del traffico <25% rispetto alla portata di servizio	2	NO
Riduzione della complessità nella tipologia del traffico	1	NO

(*) Essendo in una zona commerciale, dove gli esercizi rimangono chiusi al pubblico durante le ore notturne, si è ritenuto ragionevole considerare che il flusso del traffico si riduca al di sotto del 50% rispetto alla portata di servizio.

AI PROGETTI

Via Peppino Impastato, 14 - 30174 Venezia Mestre
Tel +39 041 95 75 70 - Fax +39 041 97 60 20
info@ai-progetti.it - www.ai-progetti.it

C.F. - P. IVA: 03474500273
REA 311568
PEC aiprogetti@pec.it



In seguito all'analisi dei rischi e dai dati ricevuti dalla committenza si ritiene opportuno classificare le strade motorizzate come **M5** dalle ore 12 della notte fino alle ore 6 del mattino e **M4** nelle altre ore con i seguenti valori minimi:

Categoria	Luminanza del marciapiede della carreggiata in condizioni di marciapiede asciutto e bagnato				Abbagliamento disturbo %	Illuminazione di carreggiata
	Asciutto		Bagnato			
	L_{min} [minimo mantenuto] $\text{cd} \cdot \text{m}^{-2}$	U_0 [minimo]	U_0^{min} [minimo]	$U_{0, \text{min}}^{\text{min}}$ [minimo]		
M1	2,00	0,40	0,70	0,15	16	0,35
M2	1,50	0,40	0,70	0,15	16	0,35
M3	1,00	0,40	0,60	0,15	16	0,30
M4	0,75	0,40	0,60	0,15	16	0,30
M5	0,50	0,35	0,40	0,15	15	0,30
M6	0,20	0,35	0,40	0,15	26	0,30

a) L'unità longitudinale (U_0) fornisce una misura della regolarità dello schermo rispetto di zone luminose e zone scure sul marciapiede e, in quanto tale, è pertinente soltanto alle condizioni visive su tratti di strada lunghi e intensivi, e pertanto dovrebbe essere applicato soltanto in tali circostanze. I valori indicati nella colonna sono quelli minimi raccomandati per la specifica categoria illuminotecnica, tuttavia possono essere modificati allorché si stabiliscono, mediante analisi, circostanze specifiche relative alla configurazione e all'uso della strada, oppure quando sono definiti specifici requisiti nazionali.

b) Questo è l'unico valore in condizioni di strada bagnata. Esso può essere applicato in aggiunta ai valori in condizioni di marciapiede asciutto in conformità agli specifici requisiti nazionali. I valori indicati nella colonna possono essere modificati in base a specifici requisiti nazionali.

c) I valori indicati nella colonna F_{10} sono quelli minimi raccomandati per la specifica categoria illuminotecnica, tuttavia, possono essere modificati in base a specifici requisiti nazionali.

d) Questo criterio può essere applicato solo quando non vi sono aree di traffico con requisiti illuminotecnici propri adattati alla categoria. I valori indicati sono in via provvisoria e possono essere modificati quando sono specificati gli specifici requisiti nazionali o i requisiti dei singoli schermi. Tali valori possono essere maggiori o minori di quelli indicati, tuttavia si dovrebbe aver cura di garantire che venga fornito un illuminamento adeguato dello zona.

La categoria del marciapiede e della pista ciclopedonale presente, sarà determinata con le categorie comparabili tipo P in funzione della categoria illuminotecnica della strada motorizzata come illustrato nella tabella sottostante:

M4 → P2

Comparazione di categorie illuminotecniche						
Categoria illuminotecnica comparabile						
Condizione	M1	M2	M3	M4	M5	M6
Se $Q_0 \leq 0,05 \text{ sr}^{-1}$	C0	C1	C2	C3	C4	C5
Se $0,05 \text{ sr}^{-1} < Q_0 \leq 0,08 \text{ sr}^{-1}$	C1	C2	C3	C4	C5	C5
Se $Q_0 > 0,08 \text{ sr}^{-1}$	C2	C3	C4	C5	C5	C5
			P1	P2	P3	P4

Nota: Per il valore di Q_0 vedere punto 13 e l'appendice B.

Con i seguenti valori minimi:

Categoria	Illuminamento orizzontale		Requisito aggiuntivo se è necessario il riconoscimento tattile	
	E_{min} [minimo mantenuto] lx	E_{min} [minimo mantenuto] lx	E_{min} [minimo mantenuto] lx	E_{min} [minimo mantenuto] lx
P1	10,0	3,00	5,0	5,0
P2	10,0	2,00	3,0	2,0
P3	7,50	1,50	2,5	1,5
P4	5,00	1,00	1,5	1,0
P5	3,00	0,60	1,0	0,6
P6	2,00	0,40	0,6	0,3
P7	Prestazione non determinata	Prestazione non determinata		

a) Per ottenere l'antiforata, il valore effettivo dell'illuminamento medio mantenuto non deve essere maggiore di 1,5 volte il valore minimo di E_{min} indicato per la categoria.

AI PROGETTI

Via Peppino Impastato, 14 - 30174 Venezia Mestre
Tel +39 041 95 75 70 - Fax +39 041 97 60 20
info@ai-progetti.it - www.ai-progetti.it

C.F. - P. IVA: 03474500273
REA 311568
PEC ai-progetti@pec.it



Per quanto riguarda gli attraversamenti pedonali inseriti in progetto sarà prevista un'illuminazione secondo la specifica tecnica UNI/TS 11726 determinata in funzione della categoria illuminotecnica della strada con i seguenti valori minimi:

CATEGORIA DELLA STRADA	CATEGORIA ATTRAVERSAMENTO PEDONALE	ILLUMINAMENTO DEL PIANO VERTICALE
M4	EV2	30 lx

SORGENTI LUMINOSE UTILIZZATE

Descrizione	Tipo	Potenza	Lumen/Watt	Rischio foto/biologico
LED	1 modulo	39	123,08	ASSENTE
LED	1 modulo	39	123,08	ASSENTE
LED	2 moduli	51,5	129,71	ASSENTE
LED	2 moduli	40,5	138,02	ASSENTE
LED	2 moduli	51,5	132,43	ASSENTE
LED	2 moduli	40,5	138	ASSENTE
LED	2 moduli	40,5	138,02	ASSENTE
LED	2 moduli	51,5	132,43	ASSENTE
LED	2 moduli	76	121,71	ASSENTE
LED	2 moduli	76	130,92	ASSENTE
LED	3 moduli	59,5	136,9	ASSENTE

APPARECCHI DI ILLUMINAZIONE UTILIZZATI

Marca	Modello	Potenza [W]	Rendimento
AEC	COMPASS 1 2Z8 S03 3.40-3M	59,5	100%
AEC	COMPASS 1 2Z8 S03 3.50-2M	51,5	100%
AEC	COMPASS 1 2Z8 STU-M 3.40-2M	40,5	100%
AEC	COMPASS 1 2Z8 STU-M 3.50-2M	51,5	100%
AEC	COMPASS 1 2Z8 STU-S 3.40-2M	40,5	100%
AEC	COMPASS 1 2Z8 STU-W 3.40-2M	40,5	100%
AEC	COMPASS 1 2Z8 STU-W 3.50-2M	51,5	100%
AEC	ITALO 1 0F6 OP-DX 3.5-1M	39	100%
AEC	ITALO 1 0F6 OP-DX 3.5-2M	76	100%
AEC	ITALO 1 0F6 OP-DX 4.5-2M	76	100%
AEC	ITALO 1 0F6 OP-SX 3.5-1M	39	100%

Tali armature stradali avranno grado di protezione non inferiore a IP66.

SISTEMA DI REGOLAZIONE DEL FLUSSO LUMINOSO

Gli apparecchi di illuminazione previsti in progetto sono dotati, al loro interno, di un alimentatore con sistema di regolazione denominato "DA". Tale alimentatore consente la riduzione del flusso luminoso in modo automatico ed autonomo per singolo punto luce dalle ore 12:00 della notte alle ore 6:00 del mattino. Saranno comunque garantiti i valori minimi normativi.

AI PROGETTI

Via Peppino Impastato, 14 - 30174 Venezia Mestre
Tel +39 041 95 75 70 - Fax +39 041 97 60 20
info@ai-progetti.it - www.ai-progetti.it

C.F. - P. IVA: 03474500273
REA 311568
PEC aiprogetti@pec.it



PRESTAZIONE ENERGETICA DELL'IMPIANTO IN CONFORMITA' AL D.M. 27/09/2017 E SS.MM.II.

Con riferimento alla tabella che segue, l'impianto di illuminazione pubblica avrà l'indice IPEI maggiore o uguale di quello corrispondente alla classe B fino all'anno 2020 compreso, a quello della classe A fino all'anno 2025 compreso e a quello della classe A+ a partire dall'anno 2026.

INTERVALLI DI CLASSIFICAZIONE ENERGETICA	
Classe energetica impianto	IPEI*
A++	$IPEI^* < 0,85 - (0,10 \times n)$
A+	$0,55 \leq IPEI^* < 0,65$
A	$0,65 \leq IPEI^* < 0,75$
B	$0,75 \leq IPEI^* < 0,85$
C	$0,85 \leq IPEI^* < 1,00$
D	$1,00 \leq IPEI^* < 1,35$
E	$1,35 \leq IPEI^* < 1,75$
F	$1,75 \leq IPEI^* < 2,30$
G	$2,30 \leq IPEI^* < 3,00$
	$IPEI^* \geq 3,00$

L'indice IPEI che viene utilizzato per la valutazione delle prestazioni energetiche degli impianti di illuminazione è definito come segue:

$$IPEI^* = \frac{D_p}{D_{p,R}}$$

con D_p = **Densità di Potenza di progetto**, che si calcola come segue:

$$D_p = \frac{\sum P_{app}}{\sum_{i=1}^n \left(E_i \cdot \frac{0,80}{MF_i} \cdot A_i \right)}$$

in cui:

P_{app} (W) potenza attiva totale assorbita dagli apparecchi di illuminazione, intesa come somma delle potenze assorbite dalle sorgenti e dalle componenti presenti all'interno dello stesso apparecchio di illuminazione (accenditore, alimentatore/reattore, condensatore, ecc.). Tale potenza è quella che l'apparecchio di illuminazione assorbe dalla linea elettrica durante il suo normale funzionamento a piena potenza (comprensiva quindi di ogni apparecchiatura in grado di assorbire potenza elettrica della rete);

E_i (lx) illuminamento orizzontale medio mantenuto di progetto dell'area i-esima, calcolato secondo le direttive UNI EN 13201. L'illuminamento medio mantenuto di progetto non può essere superiore del 20% rispetto al valore minimo indicato dalla norma UNI 13201-2;

MF_i coefficiente di manutenzione adottato per il calcolo dell'area i-esima.

A_i area i-esima illuminata.

n numero delle aree i-esime considerate. Le aree lungo una carreggiata che devono essere illuminate per rispettare il parametro R_{EI} (UNI 13201-2 Requisiti per il traffico motorizzato) non vanno considerate come

AI PROGETTI

aree i-esime (ovvero: per tratti stradali che non hanno aree i-esime adiacenti classificate tramite una propria categoria, va considerata unicamente la carreggiata).

e con $D_{p,R}$ = **Densità di Potenza di riferimento**, i cui valori sono riportati, in funzione del tipo di apparecchio di illuminazione, nelle tabelle seguenti.

Per le categorie illuminotecniche basate sulla luminanza (M), l'illuminamento orizzontale medio mantenuto (E_t) da utilizzare per il calcolo della densità di potenza (D_p) deve essere la media dei valori di illuminamento calcolati sulla stessa griglia dei punti utilizzati per il calcolo della luminanza in conformità alla EN 13201-3. In alternativa, se risulta impossibile effettuare il calcolo dell'illuminamento orizzontale medio mantenuto secondo la modalità sopra descritta, qualora sia stato utilizzato un manto stradale di classe C2 per il calcolo della luminanza media mantenuta, si può utilizzare la formula semplificata:

$$\bar{E}_t = \frac{L_t}{0,07}$$

Nel caso in cui il medesimo ambito presenti più aree, di cui una o più aventi categorie illuminotecniche di progetto differenti, va utilizzata come Densità di Potenza di riferimento quella relativa alla classe illuminotecnica più gravosa fra gli ambiti considerati (ovvero quella con Densità di Potenza di riferimento minore).

Nelle tabelle che seguono sono riportati i valori di Densità di Potenza di riferimento riferiti alle categorie illuminotecniche di progetto secondo la norma UNI 13201-2:

Illuminazione stradale Categoria illuminotecnica M	
Categoria illuminotecnica (secondo UNI 13201-2)	Densità di Potenza di riferimento [W/lux/m ²]
M1	0,035
M2	0,037
M3	0,040
M4	0,042
M5	0,043
M6	0,044

E' verificato il rispetto della condizione posta dal D.M. 23/12/2013, che impone un indice IPEI maggiore o uguale di quello corrispondente alla classe B, per gli impianti di pubblica illuminazione.

AI PROGETTI

Via Peppino Impastato, 14 - 30174 Venezia Mestre
Tel +39 041 95 75 70 - Fax +39 041 97 60 20
info@ai-progetti.it - www.ai-progetti.it

C.F. - P. IVA: 03474500273
REA 311568
PEC aiprogetti@pec.it



PRESTAZIONI ILLUMINOTECNICHE

Il vialetto pedonale all'interno dell'area verde è stato classificato Fbis in base alla tipologia di servizio, e in base a questa classificazione, i calcoli sono stati realizzati al fine di garantire le prestazioni illuminotecniche richieste dalle Norme UNI 11248 (Categoria illuminotecnica P2) e UNI EN 13201-2, calcolate nelle condizioni di funzionamento (vedi calcoli allegati).

SORGENTI LUMINOSE UTILIZZATE

Descrizione	Tipo	Potenza	Lumen/Watt	Rischio foto/biologico
LED	1 modulo	16	103,75	ASSENTE
LED	2 moduli	30,5	109,18	ASSENTE
LED	1 modulo	16	106,25	ASSENTE

APPARECCHI DI ILLUMINAZIONE UTILIZZATI

Marca	Modello	Potenza [W]	Rendimento
AEC	ECO RAYS TP 0F2H1 S 3.5-2M	30,5	100%
AEC	ECO RAYS TP 0F2H1 S05 3.5-1M	16	100%
AEC	ECO RAYS TP 0F2H1 STU-S 3.5-1M	16	100%

SISTEMA DI REGOLAZIONE DEL FLUSSO LUMINOSO

Gli apparecchi di illuminazione previsti in progetto sono dotati, al loro interno, di un alimentatore con sistema di regolazione denominato "DA". Tale alimentatore consente la riduzione del flusso luminoso in modo automatico ed autonomo per singolo punto luce dalle ore 12:00 della notte alle ore 6:00 del mattino. Saranno comunque garantiti i valori minimi normativi.

PRESTAZIONI ILLUMINOTECNICHE

Il campo sportivo all'interno dell'area verde è stato classificato, considerata la destinazione d'uso, per attività non agonistiche in base alla tipologia di servizio, e in base a questa classificazione, i calcoli sono stati realizzati al fine di garantire le prestazioni illuminotecniche richieste dalla Norma UNI 12464-2, calcolate nelle condizioni di funzionamento (vedi calcoli allegati).

SORGENTI LUMINOSE UTILIZZATE

Descrizione	Tipo	Potenza	Lumen/Watt	Rischio foto/biologico
LED	1 modulo	102	114,9	ASSENTE
LED	3 moduli	150	114,87	ASSENTE
LED	3 moduli	150	112,8	ASSENTE
LED	3 moduli	150	112,8	ASSENTE
LED	3 moduli	150	111,13	ASSENTE
LED	3 moduli	150	109,47	ASSENTE

APPARECCHI DI ILLUMINAZIONE UTILIZZATI

Marca	Modello	Potenza [W]	Rendimento
AEC	Galileo 1 0F6 ASC-4W 3.7-2M	102	100%
AEC	Galileo 1 0F6 ASC-4W 3.7-3M	150	100%
AEC	Galileo 1 0F6 ASC-5W 3.7-3M	150	100%
AEC	Galileo 1 0F6 ASC-5W 3.7-3M	150	100%
AEC	Galileo 1 0F6 ASC-6W 3.7-3M	150	100%
AEC	Galileo 1 0F6 ASC-7W 3.7-3M	150	100%

L'accensione e lo spegnimento dei corpi illuminanti avverrà manualmente da un quadro elettrico di zona dedicato. Il funzionamento dei corpi illuminanti sarà limitato all'utilizzo dell'impianto sportivo.

DESCRIZIONE DELLE OPERE PREVISTE STRADE PUBBLICA ILLUMINAZIONE

L'impianto di illuminazione in questione sarà realizzato e composto da:

- realizzazione di scavi di norma di sezione obbligata di mt. 0,30-0,40 x 0,80 di profondità ed eseguiti su pertinenze stradali in terreno di qualsiasi natura e consistenza con l'ausilio di macchine escavatrici e/o a mano. Il terreno di risulta dovrà essere riutilizzato per il rinterro ad avvenuta posa delle tubazioni **(si dovrà porre particolare attenzione a non danneggiare eventuali sottoservizi presenti)**.
- posa dei plinti di fondazione per l'alloggio del palo completi di pozzetto di derivazione con chiusino in ghisa riportante la denominazione "illuminazione pubblica".
- posa interrata di tubazioni doppia parete serie pesante di diametro 90mm per i tratti di strada interessati, di diametro adeguato alla sezione del cavo ed al numero delle linee elettriche e innestati direttamente nei plinti di fondazione fissandoli opportunamente con malta cementizia;
- posa dei pali a sezione circolare, in acciaio zincato verniciato dritto completi delle lavorazioni accessorie e posizionati, secondo normativa CEI 64-7, ad una distanza maggiore o uguale a 0,5 m dal limite della carreggiata (distanze inferiori possono essere adottate, in accordo con il proprietario della strada, qualora la configurazione della banchina non consenta il di stanziamento indicato dalla Norma);
- infilaggio dei cavi elettrici, posati entro tubazione interrata, di tipo FG16R16, di sezione adeguata alla potenza impiegata e alla lunghezza del tratto da alimentare, in partenza dall'armadio stradale di propria competenza;
- posa dei corpi illuminanti in classe II, con Grado di protezione IP66, completi di lampada LED, scaricatori di sovratensione e dimmer, installati sui sostegni precedentemente descritti. Tali corpi illuminanti dovranno essere opportunamente fissati su testa palo. Il cablaggio del corpo illuminante dalla linea montante avverrà sulla morsettiera in classe II installata all'interno del palo su asola con coperchio.
- Collegamento alla linea di alimentazione esistente.
- Prova degli interruttori differenziali.

AI PROGETTI

Via Peppino Impastato, 14 - 30174 Venezia Mestre
Tel +39 041 95 75 70 - Fax +39 041 97 60 20
info@ai-progetti.it - www.ai-progetti.it

C.F. - P. IVA: 03474500273
REA 311568
PEC aiprogetti@pec.it



DIMENSIONAMENTO IMPIANTO ILLUMINAZIONE ESTERNA DELL'EDIFICIO E INSEGNE

Le aree esterne che dovranno essere illuminate saranno le seguenti:

- Area parcheggio riservata ad uso pubblico;
- Corte ricevimento merci;
- Area vendita Drive-In (in cui transitano e parcheggiano le auto e camioncini per l'acquisto della merce esposta all'esterno e sotto la tettoia);
- Pannelli pubblicitari;

Il tutto illustrato nella seguente immagine.

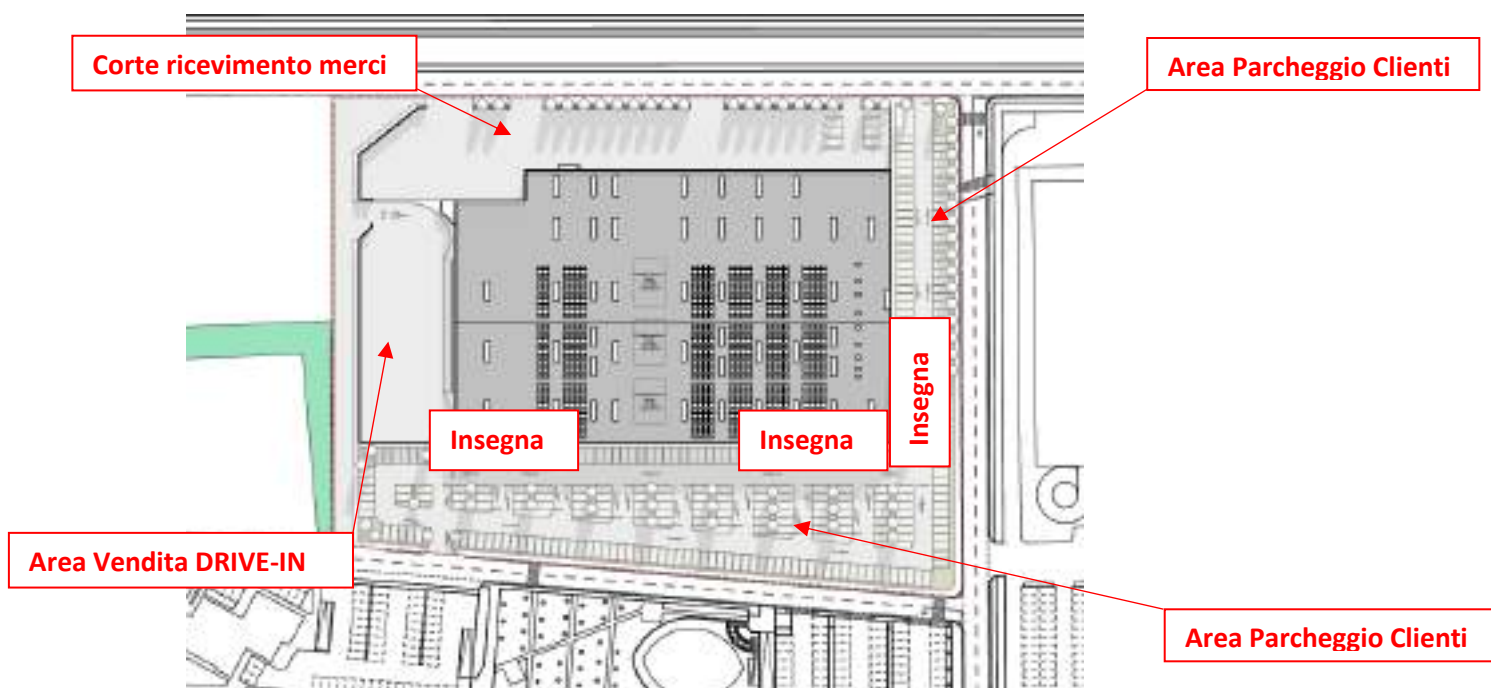

AREA DRIVE IN E AREA CORTE MERCI

Per l'illuminazione delle aree esterne, denominate Area Drive In e Area Corte Merci, vengono previsti i seguenti valori di illuminamento medio mantenuto:

- Area Drive In Em 50 lx
- Corte Merci Em 50 lx

In entrambi le aree saranno previste delle scaffalature per lo stoccaggio delle merci dotate di propria illuminazione di rinforzo con corpi illuminanti a LED posti sotto la tettoia in polycarbonato della struttura. Tale illuminazione non supererà i 200lx a pavimento come meglio illustrato nell'allegato calcolo illuminotecnico.

Inoltre nella zona di carico/scarico, all'interno dell'area Corte Merci (circa 250mq), è stata prevista un'illuminazione di rinforzo con valori massimi di illuminamento pari a 80 lx a pavimento. L'accensione di tale illuminazione sarà effettuata per un periodo di tempo limitato alle fasi di lavoro con un relè di presenza.

AI PROGETTI

PARCHEGGIO PUBBLICO

Per l'illuminazione parcheggio ad uso pubblico sarà garantito un illuminamento medio mantenuto di 20lx come indicato nella norma UNI 12464-2 e richiamato nelle linee guida Arpav.

PANNELLI PUBBLICITARI

Nelle aree perimetrali dell'insediamento per motivi pubblicitari saranno installate delle insegne luminose che rispetteranno i criteri indicati nella Legge Regionale n.17 del 7 Agosto 2009. Saranno installati dei corpi illuminanti posti frontalmente al pannello pubblicitario e orientati in modo tale da illuminare solamente il pannello come da immagine sottostante:

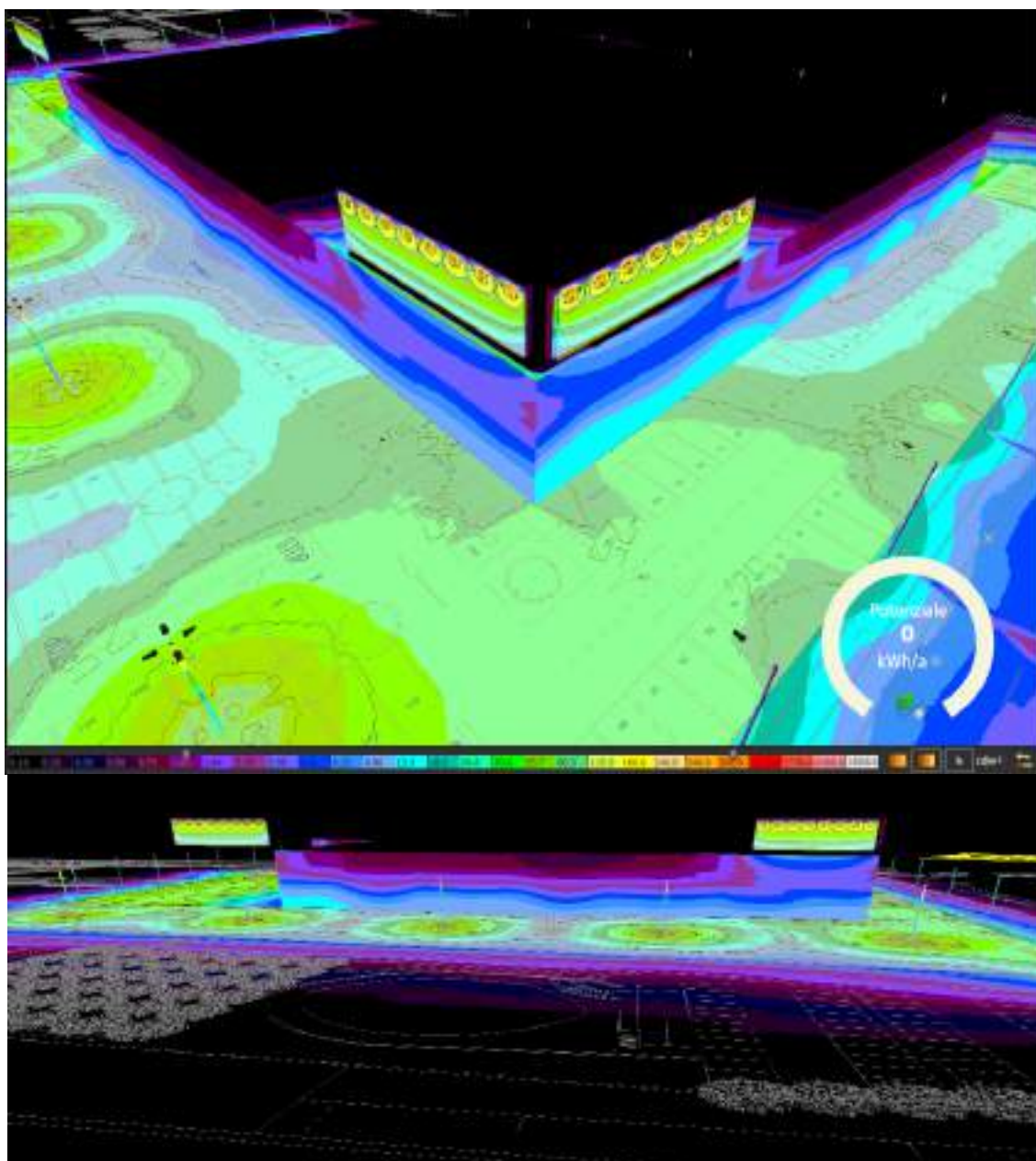

Come mostra l'immagine, tale installazione ottimizza l'illuminazione della superficie pubblicitaria, annulla il flusso luminoso verso la volta celeste e riduce l'illuminazione verso il pavimento a valori prossimi ai 20lx medi.

AI PROGETTI

Via Peppino Impastato, 14 - 30174 Venezia Mestre
Tel +39 041 95 75 70 - Fax +39 041 97 60 20
info@ai-progetti.it - www.ai-progetti.it

C.F. - P. IVA: 03474500273
REA 311568
PEC aiprogetti@pec.it



SORGENTI LUMINOSE UTILIZZATE

Descrizione	Tipo	Potenza	Lumen/Watt	Rischio foto/biologico
LED	High performance	68 W	128,8	ASSENTE
LED	Assimmetrico	118 W	135,1	ASSENTE
LED	Assimmetrico	157 W	124,5	ASSENTE
LED	Ottica Stradale	118 W	123,3	ASSENTE
LED	Micro Rodio	29 W	79,6	ASSENTE
LED	High performance	47,5 W	163,49	ASSENTE

APPARECCHI DI ILLUMINAZIONE UTILIZZATI

Marca	Modello	Potenza [W]	Rendimento
DISANO	3480 Mini Giovi - high performance – grandi aree 3000K CRI 70 68W CLD Grafite	68	100%
DISANO	1887 Rodio LED - asimmetrico 3000K CRI 80 118W CLD Grafite	118	100%
DISANO	1887 Rodio LED - asimmetrico 3000K CRI 80 157W CLD Grafite	157	100%
DISANO	1892 Rodio LED - ottica stradale 3000K CRI 80 118W CLD Grafite	118	100%
DISANO	1980 Micro Rodio - COB 3000K CRI 90 29W CLD Grafite	29	100%
DISANO	Disano illuminazione Hydro LED – High Performance	47,5	100%

AREA DRIVE IN E AREA CORTE MERCI

Per l'illuminazione dell'area vendita Drive-In saranno installati, come da planimetria allegata 11 proiettori di tipo stradale equipaggiati con lampada LED 118W installati su n.6 pali 8 m fuori terra. Inoltre lungo il perimetro dell'edificio saranno installati a parete ad altezza 9m da terra n.5 proiettori, con lampada LED 118W.

Per l'illuminazione della corte ricevimento merci saranno installati, come da planimetria allegata 10 proiettori di tipo stradale equipaggiati con lampada LED 118W installati su n.10 pali 8 m fuori terra.

Inoltre lungo il perimetro dell'edificio saranno installati a parete ad altezza 9m da terra n.7 proiettori, con lampada LED 118W.

AI PROGETTI

Via Peppino Impastato, 14 - 30174 Venezia Mestre
Tel +39 041 95 75 70 - Fax +39 041 97 60 20
info@ai-progetti.it - www.ai-progetti.it

C.F. - P. IVA: 03474500273
REA 311568
PEC aiprogetti@pec.it



Si evidenzia che tutte le scaffalature della zona "drive-in" e dell'area corte merci saranno dotate di proprio impianto di illuminazione con corpi illuminanti di tipo stagno ancorati alle tettoie sulla parte sommitale dello scaffale espositore rivolti verso il basso.

A maggior chiarimento alleghiamo rendering che illustra l'installazione:

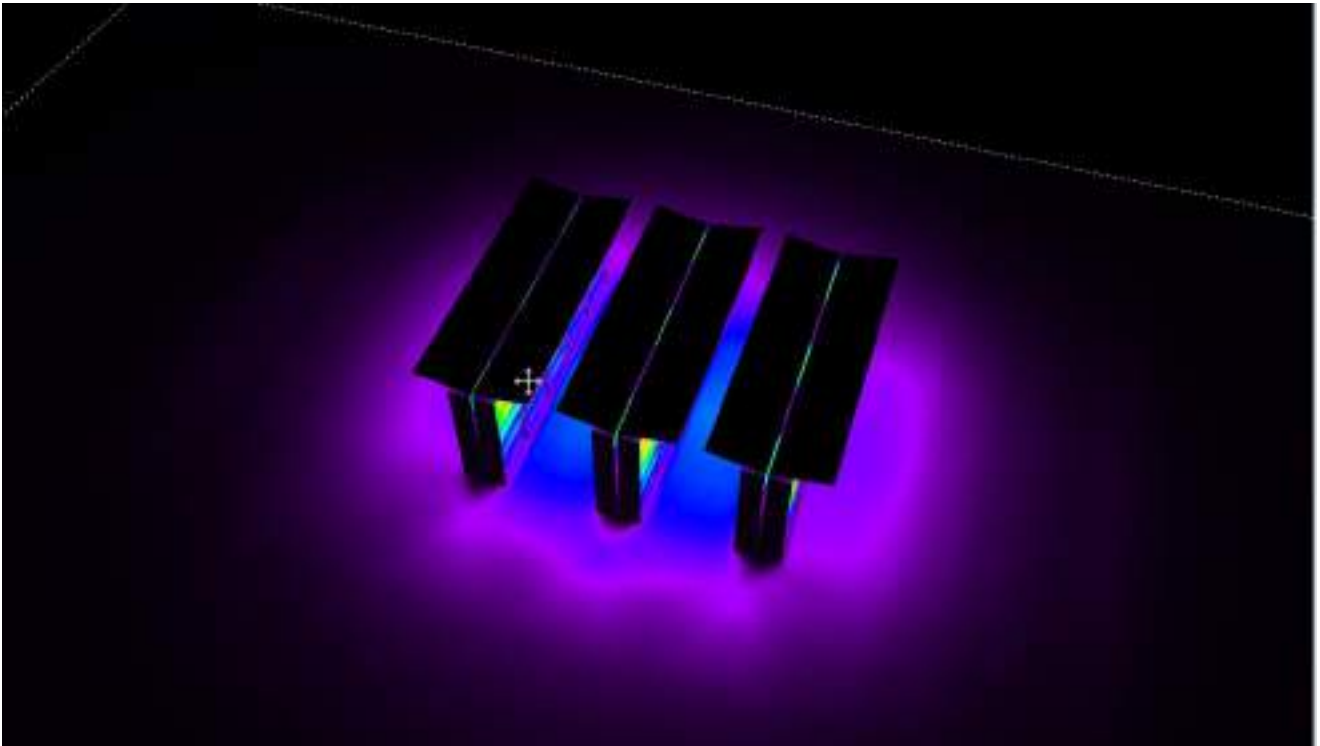

PARCHEGGIO PUBBLICO

Per l'illuminazione del parcheggio delle automobili saranno installati, come da planimetria allegata, 30 proiettori di tipo stradale equipaggiati con lampada LED 68W installati su n.15 pali 8 m fuori terra di cui 5 pali equipaggiati con 4 proiettori.

COMANDO E GESTIONE DELL'IMPIANTO DI ILLUMINAZIONE

L'impianto sarà realizzato con armature in classe II, complete di led, dimmerabili, che riducono il flusso luminoso a 10 lx per 8 ore (dalle 22:00 alle 06:00).

La gestione delle accensioni e spegnimento delle apparecchiature di illuminazione sarà eseguito da impianto di supervisione in automatico e manuale per mezzo di appropriati selettori a quadro;

AI PROGETTI

Via Peppino Impastato, 14 - 30174 Venezia Mestre
Tel +39 041 95 75 70 - Fax +39 041 97 60 20
info@ai-progetti.it - www.ai-progetti.it

C.F. - P. IVA: 03474500273
REA 311568
PEC aiprogetti@pec.it



COMPONENTI

- Saranno adatti alle condizioni di impiego ed ambientali di impianti di pubblica illuminazione e illuminazione esterna.
- I corpi illuminanti dovranno avere sorgente luminosa con temperatura di colore 3000°K.
- Saranno installati in modo da facilitarne il funzionamento, il controllo, l'esercizio e l'accesso alle concessioni da parte degli incaricati.
- Tutti i corpi illuminanti previsti presenteranno caratteristiche fotometriche conformi a quanto previsto dalla legge regionale del Veneto n. 17 del 7 Agosto 2009 e saranno rivolti a 90°.
- I dispositivi di manovra e di protezione avranno scritte o contrassegni che ne presenteranno l'identificazione.
- Il senso di manovra degli attuatori sarà conforme alla normativa vigente.
- I conduttori di terra di protezione e di equipotenzialità saranno contrassegnati col colore giallo - verde.
- Il conduttore di neutro sarà contraddistinto dal colore blu chiaro.

AI PROGETTI

Via Peppino Impastato, 14 - 30174 Venezia Mestre
Tel +39 041 95 75 70 - Fax +39 041 97 60 20
info@ai-progetti.it - www.ai-progetti.it

C.F. - P. IVA: 03474500273
REA 311568
PEC aiprogetti@pec.it



TRATTAMENTI SUPERFICIALI

I prodotti utilizzati per i trattamenti superficiali dei componenti dell'impianto non sono classificati come cancerogeni, teratogeni, allergenici, o dannosi per il sistema riproduttivo, in conformità alla direttiva 76/769/CEE e s.m.i.

Il ciclo di verniciatura prevede:

- fosfosgrassaggio flow-coating per eliminare olio, grasso, unto, macchie e residui provocati da lavorazioni meccaniche precedenti;
- risciacquo con acqua di rete;
- decapaggio flow-coating a base di acido fosforico per creare una buona aderenza per la vernice;
- risciacquo flow-coating con acqua di rete;
- risciacquo flow-coating finale con acqua demineralizzata a temperatura ambiente;
- asciugatura;
- applicazione della polvere poliestere in cabina;
- polimerizzazione in forno a temperatura costante.

Le verifiche sul prodotto verniciato prevedono:

- *prova di omogeneità*: garantisce che le superfici dei pezzi quando esaminate ad occhio nudo risultino verniciate in maniera uniforme, omogenea e corrispondenti al RAL richiesto;
- *prova di spessore del rivestimento*: lo spessore del rivestimento sul substrato viene determinato a campione;
- *prova di quadrettatura*: metodo di prova, effettuata a campione sul materiale verniciato, per valutare la resistenza del rivestimento di pittura al distacco dal supporto quando si incide un reticolo a maglie quadrate nel rivestimento fino a raggiungere il substrato;
- *prova di aderenza del rivestimento*: la misurazione dell'adesione del rivestimento di verniciatura viene eseguita a campione mediante la prova di strappo;
- *prova di resistenza alla corrosione*: il materiale metallico verniciato viene sottoposto alle prove in nebbia salina.

AI PROGETTI

Via Peppino Impastato, 14 - 30174 Venezia Mestre
Tel +39 041 95 75 70 - Fax +39 041 97 60 20
info@ai-progetti.it - www.ai-progetti.it

C.F. - P. IVA: 03474500273
REA 311568
PEC aiprogetti@pec.it



CONDUTTORI

- I conduttori di rame da installare nelle tubazioni interrate saranno unipolari, flessibili, di tipo armonizzato con guaina FG16R16 0,6/1kV.
- I conduttori saranno posti entro tubazioni che ne garantiscono la protezione meccanica.
- Le giunzioni dei conduttori saranno eseguite nelle cassette di derivazione installate nei pali, impiegando opportuni morsetti o morsettiere con grado di protezione IP 4XD con coperchio apribile solo con attrezzo, oppure con muffole o morsetti con custodie in gel nel pozzetto di derivazione aventi grado di protezione IP68.
- I conduttori impiegati nella esecuzione degli impianti saranno contraddistinti dalle colorazioni previste dalle vigenti tabelle CEI - UNEL 00722-74 e 00712.
- In particolare i conduttori di neutro e protezione saranno contraddistinti rispettivamente ed esclusivamente con il colore blu chiaro e con il bicolore giallo-verde.
- Le sezioni dei conduttori calcolate in funzione della potenza impiegata e dalla lunghezza dei circuiti (affinché la caduta di tensione non superi il valore del 5% della tensione a vuoto) saranno scelte tra quelle unificate. In ogni caso non devono superare i valori delle portate di corrente ammesse per i diversi tipi di conduttori dalle tabelle di unificazione CEI- UNEL.

Le sezioni utilizzate saranno :

- 1,5 - 2,5 mm² per i circuiti ausiliari e di allacciamento plafoniere da morsetti di derivazione.
- 16 – 10 – 6 mm² linee dorsali di distribuzione.

TUBAZIONI E SCATOLE DI DERIVAZIONE

Per l'interramento dei cavi elettrici, si dovrà procedere nel modo seguente:

sul fondo dello scavo, sufficiente per la profondità di posa comunque non inferiore a 0,5 m e privo di qualsiasi sporgenza o spigolo di roccia o di sassi, si dovrà costituire, in primo luogo, un letto di sabbia vagliata e lavata, dello spessore di almeno 10 cm, sul quale si dovrà distendere poi la tubazione.

Si dovrà procedere al reinterro dello scavo disponendo una striscia avvisatrice

Se le tubazioni non vengono installate ad una profondità di 0.5 m, dovrà essere prevista una adeguata protezione meccanica ad esempio una tubazione metallica.

Le tubazioni dovranno risultare coi singoli tratti uniti tra loro manicotti o flange, onde evitare discontinuità nella loro superficie interna.

Il diametro interno della tubazione dovrà essere in rapporto non inferiore ad 1,5 rispetto al diametro del cavo o del cerchio circoscrivente i cavi, sistemati a fascia, i diametri utilizzati saranno ϕ 90.

Per l'infilaggio dei cavi, si dovranno avere adeguati pozzetti rompitratta e di derivazione sulle tubazioni interrate e apposite tubazioni di raccordo con le scatole di derivazione posizionate sui pali (vedi disegni).

AI PROGETTI

Via Peppino Impastato, 14 - 30174 Venezia Mestre
Tel +39 041 95 75 70 - Fax +39 041 97 60 20
info@ai-progetti.it - www.ai-progetti.it

C.F. - P. IVA: 03474500273
REA 311568
PEC aiprogetti@pec.it



Il distanziamento fra tali pozzetti e cassette sarà da stabilirsi in rapporto alla natura ed alla grandezza dei cavi da infilare. Tuttavia, per cavi in condizioni medie di scorrimento e grandezza, il distanziamento resta stabilito di massima:

- ogni 25 – 30 m circa se in rettilineo;
- ogni 15 - 20 m circa se con interposta una curva.

I cavi non dovranno subire curvature tali da non agevolare eventuali aggiunte e/o sostituzioni di cavi.

Le scatole di derivazione (morsettiere da palo), saranno posizionate sui pali, di dimensioni adeguate per contenere arrivo e partenza linea, collegamento plafoniera e fusibile di protezione lampada.

I collegamenti saranno eseguiti su morsettiere.

QUADRI

Per quanto riguarda le opere oggetto di cessione al Comune, le apparecchiature elettriche saranno contenute in armadio stradale in vetroresina da esterno IP4XD, posato su basamento in calcestruzzo, con vano l'alloggiamento del quadro elettrico comprendente l'interruttore generale, gli interruttori automatici di protezione delle linee elettriche in partenza, i circuiti ausiliari e lampada spia presenza rete. Il quadro elettrico non dovrà essere accessibile ad estranei e pertanto sarà dotato di chiusura a chiave. Sarà previsto uno spazio pari al 30% dell'ingombro totale o l'installazione di interruttori di riserva, che consenta eventuali ampliamenti senza intervenire sulla struttura di base ed i relativi circuiti di potenza. Il quadro elettrico deve essere chiuso su ogni lato e posteriormente; i pannelli perimetrali devono essere asportabili a mezzo di viti. I pannelli superiori devono essere di tipo incernierato, con cerniere a scomparsa. Il costruttore dovrà effettuare le verifiche previste dalle norme applicabili (CEI 61439), in particolare la verifica termica al fine di controllare che l'involucro scelto sia adeguato a smaltire il calore generato. Sul fronte del quadro saranno poste le targhette con chiare indicazioni delle funzioni degli interruttori (CEI 64-8). In esso saranno prescritti interruttori di comando e sezionamento atti a garantire la protezione e selettività dell'impianto.

Per quanto riguarda i corpi illuminanti ad asservimento delle aree Bricoman saranno alimentati con circuiti dedicati derivati dal quadro elettrico generale dell'edificio.

PALI DI SOSTEGNO

I pali di sostegno plafoniere saranno del tipo diritto conici o rastremati in acciaio zincato a caldo (per Piazza Antonio Sala anche verniciati grigio grafite), con varie altezze fuori terra, con asola per ingresso cavi e asola per installazione morsettiera in doppio isolamento come da disegni allegati. Saranno posti come da disegni allegati, ad una distanza superiore ai 50 cm dalla carreggiata per consentire il passaggio libero. Ogni palo sarà montato su plinto in calcestruzzo di adeguate dimensioni e profondità per garantire stabilità alle sollecitazioni esterne come da disegni allegati e normativa vigente in materia e sarà comprensivo di etichetta identificatrice aggraffata allo stesso e

AI PROGETTI

Via Peppino Impastato, 14 - 30174 Venezia Mestre
Tel +39 041 95 75 70 - Fax +39 041 97 60 20
info@ai-progetti.it - www.ai-progetti.it

C.F. - P. IVA: 03474500273
REA 311568
PEC aiprogetti@pec.it



resistente alle intemperie. Alla base di ogni palo sarà posto un pozzetto di derivazione per il cavo di alimentazione.

SISTEMI DI PROTEZIONE ADOTTATI

Tutti i circuiti elettrici saranno protetti dal corto circuito e dal sovraccarico impiegando interruttori magnetotermici aventi potere di interruzione non inferiori al valore di corrente di corto circuito presunta in base al punto di installazione e separeranno le linee luce dalle linee forza motrice. Detti interruttori saranno dimensionati in modo da poter soddisfare le seguenti condizioni prescritte dalle normative: (vedi schema allegato).

per sovraccarico $I_b < I_n < I_z$

$I_f < 1,45 I_z$ (per interruttori ad uso domestico)

$I_f < 1,30 I_z$ (Per interruttori ad uso industriale secondo CEI EN 60947-2)

Per corto circuito $I^2 t \leq k^2 S^2$

dove: I_b = corrente di impiego
 I_n = corrente nominale dell'interruttore
 I_f = corrente di sicuro funzionamento dell'interruttore automatico
 I_z = portata termica della conduttura
 $I^2 t$ = energia specifica passante in caso di c.c.
 S = sezione della conduttura
 K = costante legata al tipo di conduttore (115 Cu isolato in PVC e 143 Cu isolato in EPR)

La protezione contro i contatti diretti con parti attive sarà assicurata mediante la realizzazione di questi sistemi;

PROTEZIONE MEDIANTE ISOLAMENTO DELLE PARTI ATTIVE

Le parti attive saranno completamente ricoperte con un isolamento che possa essere rimosso solo mediante distruzione.

L'isolante dei componenti elettrici costruito in fabbrica dovrà soddisfare le relative Norme.

Per gli altri componenti elettrici la protezione sarà assicurata da un isolamento tale da resistere alle influenze meccaniche, chimiche, elettriche e termiche alle quali potrà essere soggetto nell'esercizio.

PROTEZIONE MEDIANTE INVOLUCRI E BARRIERE

Le parti attive saranno poste entro involucri o dietro barriere tali da assicurare almeno il grado di protezione IPXXB o il grado IPXXD nel caso di superfici orizzontali a portata di mano.

Le barriere o gli involucri saranno saldamente fissati ed avranno una sufficiente stabilità e durata nel tempo in modo da conservare il richiesto grado di protezione ed una conveniente separazione delle parti attive, nelle condizioni di servizio prevedibili, tenuto conto delle condizioni ambientali.

AI PROGETTI

Via Peppino Impastato, 14 - 30174 Venezia Mestre
Tel +39 041 95 75 70 - Fax +39 041 97 60 20
info@ai-progetti.it - www.ai-progetti.it

C.F. - P. IVA: 03474500273
REA 311568
PEC aioprogetti@pec.it



Quando si rendesse necessario, per ragioni di esercizio, aprire gli involucri, si dovrà eseguire una delle seguenti operazioni:

- uso di un attrezzo o una chiave se in esemplare unico ed affidata al personale addestrato;
- sezionamento delle parti attive mediante aperture con interblocco;
- interposizione di barriere o schemi che garantiscono un grado di protezione non inferiore ad IPXXB.

PROTEZIONE CONTRO I CONTATTI INDIRECTI MEDIANTE INTERRUZIONE AUTOMATICA DEL CIRCUITO

La protezione di eventuali contatti con masse metalliche normalmente non in tensione ma che per difetto di isolamento dovessero assumere un potenziale pericoloso, sarà garantita mediante il sistema di interruzione automatica del circuito.

Il dispositivo di protezione, interromperà automaticamente l'alimentazione al circuito o al componente elettrico che lo stesso dispositivo protegge in modo che in caso di guasto nel circuito o nel componente, tra una parte attiva ed una massa o un conduttore di protezione non possa persistere, per una durata sufficiente a causare un rischio di effetti fisiologici dannosi in una persona in contatto con parti simultaneamente accessibili, una tensione di contatto presunta superiore a 50 V valore efficace in c.a.

Per quanto riguarda l'impianto elettrico fornito in MT la protezione contro i contatti sarà ottenuta con l'interruzione automatica dell'alimentazione, dimodoché al manifestarsi di un guasto, in ogni parte dell'impianto elettrico, tra una parte attiva ed una massa od un conduttore di protezione, l'interruzione automatica dell'alimentazione avvenga entro il tempo specificato, soddisfacendo la seguente condizione:

$$Z_s \times I_a \leq U_0$$

Z_s è l'impedenza dell'anello di guasto che comprende la sorgente, il conduttore attivo fino al punto di guasto ed il conduttore tra il punto di guasto e la sorgente

I_d è la corrente che provoca l'interruzione automatica del dispositivo di protezione entro il tempo definito nella Tabella 41A della norma CEI 64-8 in funzione della tensione nominale U_0 oppure, nelle condizioni specificate in 413.1.3.5, entro un tempo convenzionale non superiore a 5 secondi.

U_0 è la tensione nominale in c.a., valore efficace tra fase e terra

AI PROGETTI

Via Peppino Impastato, 14 - 30174 Venezia Mestre
Tel +39 041 95 75 70 - Fax +39 041 97 60 20
info@ai-progetti.it - www.ai-progetti.it

C.F. - P. IVA: 03474500273
REA 311568
PEC aiprogetti@pec.it



Tabella 41A - Tempi massimi di interruzione per i sistemi TN

U_0 (V)	Tempo di interruzione (s)
120	0,8
230	0,4
400	0,2
> 400	0,1

L'art. 413.1.3.5 prescrive che i tempi di interruzione convenzionali non superiori a 5s sono ammessi per i circuiti di distribuzione.

Un tempo superiore a quello richiesto dalla Tabella 41A ma non superiore a 5s è ammesso anche per un circuito terminale che alimenti solo componenti elettrici fissi, cioè senza prese a spina.

Nei sistemi TN-S i valori delle correnti di guasto sono tali per cui sia possibile utilizzare per la protezione contro i contatti indiretti, in accordo con l'articolo 413.1.38, i dispositivi di protezione contro le sovracorrenti (interruttori magnetotermici).

La norma consente inoltre l'utilizzo di interruttori di tipo differenziale.

RESISTENZA DI ISOLAMENTO

Per tutte le parti di impianto comprese fra due fusibili o interruttori automatici successivi o poste a valle dell'ultimo fusibile o interruttore automatico, la resistenza di isolamento verso terra o fra conduttori appartenenti a fasi o polarità diverse non sarà inferiore a:

- 500.000 Ohm per i sistemi con tensione nominale superiore a 50V e fino a 500V compresi.

PROTEZIONE CONTRO LE SOVRATENSIONI

Al fine di proteggere le apparecchiature elettroniche all'interno delle armature stradali (alimentatore, LED, ecc.) e all'interno del quadro elettrico generale, vengono previste delle protezioni da sovratensioni integrate nelle armature stesse.

AI PROGETTI

Via Peppino Impastato, 14 - 30174 Venezia Mestre
Tel +39 041 95 75 70 - Fax +39 041 97 60 20
info@ai-progetti.it - www.ai-progetti.it

C.F. - P. IVA: 03474500273
REA 311568
PEC aiprogetti@pec.it



PRESCRIZIONI

- I parallelismi e gli incroci con altre condutture interrate, telefoniche, media tensione, gas, ecc., devono essere eseguiti mantenendo le distanze secondo quanto stabilito dalla norma CEI 11-17 e 11-47.
- I sostegni degli apparecchi di illuminazione devono essere distanziati dai conduttori di linee elettriche aeree esterne secondo quanto previsto dalla Norma Cei 64-7 art. 3.6.3 e precisamente:
 - 1m dai conduttori di linee con tensione fino a 1000V se a corrente alternata, e fino a 1500V se a corrente continua, il distanziamento minimo sopra indicato può essere ridotto a 0.5m quando si tratti di conduttori in cavo aereo ed in ogni caso nell'abitato;
 - della misura calcolata con la relazione $(3+0.015xU)$ dove U è il valore della tensione espresso in kV, dalle linee con tensioni oltre 1000V a corrente alternata ed oltre 1500V a corrente continua, il distanziamento può essere ridotto a $(1+0.015xU)$ per le linee in cavo aereo.
- Dovrà essere eliminato l'eventuale regolatore di flusso presente nel circuito di alimentazione.

AI PROGETTI

Via Peppino Impastato, 14 - 30174 Venezia Mestre
Tel +39 041 95 75 70 - Fax +39 041 97 60 20
info@ai-progetti.it - www.ai-progetti.it

C.F. - P. IVA: 03474500273
REA 311568
PEC aiprogetti@pec.it



DOVERI DELL'IMPRESA E DELLA COMMITTENZA

L'impresa installatrice sarà tenuta ad eseguire gli impianti a regola d'arte, utilizzando allo scopo materiali parimenti costruiti a regola d'arte, ovvero secondo le norme tecniche di sicurezza dell'UNI, del CEI, nonché del rispetto di quanto prescritto dalla legislazione tecnica vigente in materia.

Al termine dei lavori l'impresa installatrice sarà tenuta a rilasciare al committente la dichiarazione di conformità degli impianti nel rispetto delle norme di cui all'art. 7 del D.M. 37/08. Di tale dichiarazione, sottoscritta dal titolare dell'impresa installatrice e compilata sul modello previsto da tale Decreto, faranno parte integrante la relazione contenente la tipologia dei materiali e il presente progetto.

L'impresa installatrice dovrà redarre la dichiarazione di conformità in 3 copie di cui:

- 1 copia dovrà essere conservata negli archivi dell'impresa;
- 1 copia al committente;
- 1 copia, nel caso di nuovo impianto e di edificio privo di agibilità e/o abitabilità, dovrà essere consegnata al committente che dovrà spedire al Comune in cui sono installati gli impianti; nel caso in cui l'edificio in oggetto abbia invece già l'abitabilità, l'installatore dovrà far pervenire, entro 30 giorni dal termine dei lavori, la dichiarazione di conformità al Comune.

Il proprietario dell'impianto sarà tenuto ad affidare i lavori di installazione, di trasformazione, di ampliamento e di manutenzione degli impianti ad imprese abilitate e dovrà far eseguire le manutenzioni e le verifiche necessarie per il buon funzionamento dello stesso.

AI PROGETTI

Via Peppino Impastato, 14 - 30174 Venezia Mestre
Tel +39 041 95 75 70 - Fax +39 041 97 60 20
info@ai-progetti.it - www.ai-progetti.it

C.F. - P. IVA: 03474500273
REA 311568
PEC aiprogetti@pec.it



VERIFICHE E COLLAUDI DA ESEGUIRE AL TERMINE DEI LAVORI

L'impresa installatrice sarà tenuta a fornire la seguente documentazione:

- -schemi elettrici unifilari aggiornati;
- -planimetrie con percorsi delle tubazioni ed ubicazione delle apparecchiature (punti luce, quadri elettrici);
- Tutti gli elaborati dovranno essere firmati da un tecnico abilitato;

L'impresa installatrice sarà tenuta ad eseguire le seguenti verifiche:

Verifiche a campione:

- Conformità dei componenti elettrici alle prescrizioni di sicurezza;
- Metodi di protezione contro i contatti diretti ed indiretti;
- Scelta dei conduttori per quanto riguarda la portata e la caduta di tensione;
- Taratura dei dispositivi di protezione;
- Controllo dei conduttori di neutro e di protezione,
- Idoneità delle connessioni dei conduttori;
- Verifiche illuminotecniche in campo.

Misurazioni:

- Misura della resistenza di terra;
- Misura della resistenza di isolamento;
- Misura della funzionalità degli interruttori differenziali.

ALLEGATI

- Documentazione relativa alle verifiche illuminotecniche
- Schede tecniche e certificazioni
- Fascicolo elaborati grafici

Mestre lì, 26/04/2023

IL TECNICO

AI PROGETTI

Via Peppino Impastato, 14 - 30174 Venezia Mestre
Tel +39 041 95 75 70 - Fax +39 041 97 60 20
info@ai-progetti.it - www.ai-progetti.it

C.F. - P. IVA: 03474500273
REA 311568
PEC aiprogetti@pec.it



**CALCOLI
ILLUMINOTECNICI AREE
IN CESSIONE AL
COMUNE**

PUBBLICA ILLUMINAZIONE

Impianto : VENEZIA

Numero progetto : 471a -22

Cliente : A&S ENGINEER

Autore : DAVIN

Data : 09.11.2022

I seguenti valori si basano su calcoli esatti di lampade e punti luce tarati e sulla loro disposizione. Nella realtà potranno verificarsi differenze graduali. Resta escluso qualunque diritto di garanzia per i dati dei punti luce. Il produttore non si assume alcuna responsabilità per danni anche parziali derivanti all'utente o a terzi.

Questa clausola di esclusione della responsabilità è valida per qualsiasi motivo giuridico e comprende in particolare anche la responsabilità per il personale ausiliario.

Sommario

Copertina	1
Sommario	2
1	Dati punti luce
1.1	AEC ILLUMINAZIONE SRL, COMPASS 1 2Z8 S03 3.40... (COMPASS 1 2Z8 S...)
1.1.1	Pagina dati 4
1.2	AEC ILLUMINAZIONE SRL, COMPASS 1 2Z8 STU-S 3.... (COMPASS 1 2Z8 S...)
1.2.1	Pagina dati 5
1.3	AEC ILLUMINAZIONE SRL, ECO RAYS TP 0F2H1 STU-... (ECO RAYS TP 0F2...)
1.3.1	Pagina dati 6
1.4	AEC ILLUMINAZIONE SRL, ECO RAYS TP 0F2H1 S 3.... (ECO RAYS TP 0F2...)
1.4.1	Pagina dati 7
1.5	AEC ILLUMINAZIONE SRL, COMPASS 1 2Z8 S03 3.50... (COMPASS 1 2Z8 S...)
1.5.1	Pagina dati 8
1.6	AEC ILLUMINAZIONE SRL, ITALO 1 0F6 OP-DX 4.5-... (ITALO 1 0F6 OP-...)
1.6.1	Pagina dati 9
1.7	AEC ILLUMINAZIONE SRL, ITALO 1 0F6 OP-SX 3.5-... (ITALO 1 0F6 OP-...)
1.7.1	Pagina dati 10
1.8	AEC ILLUMINAZIONE SRL, ITALO 1 0F6 OP-DX 3.5-... (ITALO 1 0F6 OP-...)
1.8.1	Pagina dati 11
1.9	AEC ILLUMINAZIONE SRL, Galileo 1 0F6 ASC-4W 3... (Galileo 1 0F6 A...)
1.9.1	Pagina dati 12
1.10	AEC ILLUMINAZIONE SRL, Galileo 1 0F6 ASC-5W 3... (Galileo 1 0F6 A...)
1.10.1	Pagina dati 13
1.11	AEC ILLUMINAZIONE SRL, Galileo 1 0F6 ASC-6W 3... (Galileo 1 0F6 A...)
1.11.1	Pagina dati 14
1.12	AEC ILLUMINAZIONE SRL, Galileo 1 0F6 ASC-7W 3... (Galileo 1 0F6 A...)
1.12.1	Pagina dati 15
1.13	AEC ILLUMINAZIONE SRL, Galileo 1 0F6 ASC-4W 3... (Galileo 1 0F6 A...)
1.13.1	Pagina dati 16
1.14	AEC ILLUMINAZIONE SRL, Galileo 1 0F6 ASC-5W 3... (Galileo 1 0F6 A...)
1.14.1	Pagina dati 17
1.15	AEC ILLUMINAZIONE SRL, Galileo 1 0F6 ASC-5W 3... (Galileo 1 0F6 A...)
1.15.1	Pagina dati 18
1.16	AEC ILLUMINAZIONE SRL, ECO RAYS TP 0F2H1 S05 ... (ECO RAYS TP 0F2...)
1.16.1	Pagina dati 19
1.17	AEC ILLUMINAZIONE SRL, COMPASS 1 2Z8 STU-M 3.... (COMPASS 1 2Z8 S...)
1.17.1	Pagina dati 20
1.18	AEC ILLUMINAZIONE SRL, COMPASS 1 2Z8 STU-W 3.... (COMPASS 1 2Z8 S...)
1.18.1	Pagina dati 21
1.19	AEC ILLUMINAZIONE SRL, COMPASS 1 2Z8 STU-W 3.... (COMPASS 1 2Z8 S...)
1.19.1	Pagina dati 22
1.20	AEC ILLUMINAZIONE SRL, COMPASS 1 2Z8 STU-M 3.... (COMPASS 1 2Z8 S...)
1.20.1	Pagina dati 23
1.21	AEC ILLUMINAZIONE SRL, ITALO 1 0F6 OP-DX 3.5-... (ITALO 1 0F6 OP-...)
1.21.1	Pagina dati 24
2	Impianto esterno 1
2.1	Descrizione, Impianto esterno 1
2.1.1	Dati punti luce/Elementi dell' interno 25
2.1.2	Pianta 28
2.2	Risultati calcolo, Impianto esterno 1
2.2.1	Tabella, Suolo (E) 29
2.2.2	Tabella, Superficie di misurazione 1 (E) 30
2.2.3	Tabella, Superficie di misurazione 3 (E) 32
2.2.4	Tabella, Suolo (L) 40
3	CARREGGAI 1
3.1	Descrizione, CARREGGAI 1
3.1.1	Pianta 41

Sommario

3.2	Riepilogo, CARREGGAIATA 1	
3.2.1	Panoramica risultato, CARREGGAIATA 1	42
4	CARREGGIATA 2	
4.1	Descrizione, CARREGGIATA 2	
4.1.1	Pianta	44
4.2	Riepilogo, CARREGGIATA 2	
4.2.1	Panoramica risultato, CARREGGIATA 2	45
5	CAREGGIATA 3	
5.1	Descrizione, CAREGGIATA 3	
5.1.1	Pianta	47
5.2	Riepilogo, CAREGGIATA 3	
5.2.1	Panoramica risultato, CAREGGIATA 3	48
6	PASSAGGIO PEDONALE 1 - 3	
6.1	Descrizione, PASSAGGIO PEDONALE 1 - 3	
6.1.1	Dati punti luce/Elementi dell' interno	50
6.1.2	Pianta	53
6.2	Risultati calcolo, PASSAGGIO PEDONALE 1 - 3	
6.2.1	Tabella, Attraversamento pedonale 1 (E verticale)	54
6.2.2	Tabella, Superficie di misurazione 1 (Ev, 270°)	55
6.2.3	Tabella, Superficie di misurazione 2 (Ev, 90°)	56
7	PASSAGGIO PEDONALE 2	
7.1	Descrizione, PASSAGGIO PEDONALE 2	
7.1.1	Dati punti luce/Elementi dell' interno	57
7.1.2	Pianta	60
7.2	Riepilogo, PASSAGGIO PEDONALE 2	
7.2.1	Panoramica risultato, Area di valutazione 1	61
7.2.2	Sommario Esterni, PASSAGGIO PEDONALE 2	62
7.3	Risultati calcolo, PASSAGGIO PEDONALE 2	
7.3.1	Tabella, Attraversamento pedonale 1 (E verticale)	63
8	CAMPETTO	
8.1	Descrizione, CAMPETTO	
8.1.1	Dati punti luce/Elementi dell' interno	64
8.1.2	Pianta	67
8.2	Riepilogo, CAMPETTO	
8.2.1	Panoramica risultato, Impianto sportivo 1.1	68
8.3	Risultati calcolo, CAMPETTO	
8.3.1	Tabella, Impianto sportivo 1.1 (E)	69

Oggetto : PUBBLICA ILLUMINAZIONE
Impianto : VENEZIA
Numero progetto : 471a -22
Data : 09.11.2022

1 Dati punti luce

1.1 AEC ILLUMINAZIONE SRL, COMPASS 1 2Z8 S03 3.40... (COMPASS 1 2Z8 S...)

1.1.1 Pagina dati

Marca: AEC ILLUMINAZIONE SRL

COMPASS 1 2Z8 S03 3.40-3M

COMPASS 1 2Z8 S03 3.40-3M

Dati punti luce

Rendimento punto luce : 100%
Rendimento punto luce : 136.97 lm/W
Classificazione : A30 ↓100.0% ↑0.0%
CIE Flux Codes : 36 74 98 100 100
UGR 4H 8H : 39.7 / 19.4
Potenza : 59.5 W
Flusso luminoso : 8150 lm

Sorgenti:

Quantità : 1
Nome : L-COM-2Z8-3000-400-3M-
Temp. Di Colore : 3000
Flusso luminoso : 8150 lm
Resa cromatica : 70

Dimensioni : Ø540 mm x 85 mm

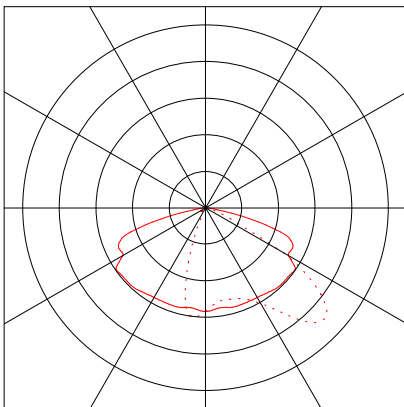

Oggetto : PUBBLICA ILLUMINAZIONE
Impianto : VENEZIA
Numero progetto : 471a -22
Data : 09.11.2022

1 Dati punti luce

1.2 AEC ILLUMINAZIONE SRL, COMPASS 1 2Z8 STU-S 3.... (COMPASS 1 2Z8 S...)

1.2.1 Pagina dati

Marca: AEC ILLUMINAZIONE SRL

COMPASS 1 2Z8 STU-S 3.40-2M

COMPASS 1 2Z8 STU-S 3.40-2M

Dati punti luce

Rendimento punto luce : 100%
Rendimento punto luce : 138.02 lm/W
Classificazione : A30 ↓100.0% ↑0.0%
CIE Flux Codes : 45 77 97 100 100
UGR 4H 8H : 42.8 / 20.0
Potenza : 40.5 W
Flusso luminoso : 5590 lm

Sorgenti:

Quantità : 1
Nome : L-COM-2Z8-3000-400-2M-
Temp. Di Colore : 3000
Flusso luminoso : 5590 lm
Resa cromatica : 70

Dimensioni : Ø540 mm x 85 mm

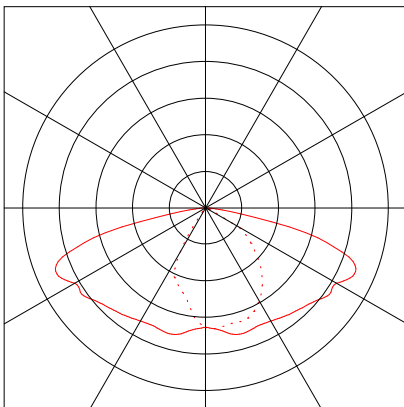

Oggetto : PUBBLICA ILLUMINAZIONE
Impianto : VENEZIA
Numero progetto : 471a -22
Data : 09.11.2022

1 Dati punti luce

1.3 AEC ILLUMINAZIONE SRL, ECO RAYS TP 0F2H1 STU-... (ECO RAYS TP 0F2...)

1.3.1 Pagina dati

Marca: AEC ILLUMINAZIONE SRL

ECO RAYS TP 0F2H1 STU-S 3.5-1M

ECO RAYS TP 0F2H1 STU-S 3.5-1M

Dati punti luce

Rendimento punto luce : 100%
Rendimento punto luce : 103.75 lm/W
Classificazione : A30 ↓100.0% ↑0.0%
CIE Flux Codes : 40 73 97 100 100
UGR 4H 8H : 43.3 / 21.1
Potenza : 16 W
Flusso luminoso : 1660 lm

Sorgenti:

Quantità : 1
Nome : L-ECR-0F2H1-3000-525-1
Temp. Di Colore : 3000
Flusso luminoso : 1660 lm
Resa cromatica : 70

Dimensioni : Ø497 mm x 665 mm

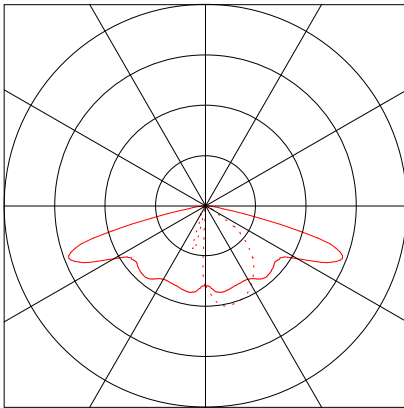

Oggetto : PUBBLICA ILLUMINAZIONE
Impianto : VENEZIA
Numero progetto : 471a -22
Data : 09.11.2022

1 Dati punti luce

1.4 AEC ILLUMINAZIONE SRL, ECO RAYS TP 0F2H1 S 3.... (ECO RAYS TP 0F2...)

1.4.1 Pagina dati

Marca: AEC ILLUMINAZIONE SRL

ECO RAYS TP 0F2H1 S 3.5-2M

ECO RAYS TP 0F2H1 S 3.5-2M

Dati punti luce

Rendimento punto luce : 100%
Rendimento punto luce : 109.18 lm/W
Classificazione : A30 ↓100.0% ↑0.0%
CIE Flux Codes : 27 65 97 100 100
UGR 4H 8H : 35.5 / 34.5
Potenza : 30.5 W
Flusso luminoso : 3330 lm

Sorgenti:

Quantità : 1
Nome : L-ECR-0F2H1-3000-525-2
Temp. Di Colore : 3000
Flusso luminoso : 3330 lm
Resa cromatica : 70

Dimensioni : Ø497 mm x 665 mm

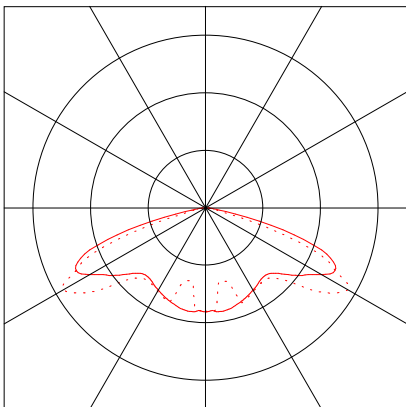

Oggetto : PUBBLICA ILLUMINAZIONE
Impianto : VENEZIA
Numero progetto : 471a -22
Data : 09.11.2022

1 Dati punti luce

1.5 AEC ILLUMINAZIONE SRL, COMPASS 1 2Z8 S03 3.50... (COMPASS 1 2Z8 S...)

1.5.1 Pagina dati

Marca: AEC ILLUMINAZIONE SRL

COMPASS 1 2Z8 S03 3.50-2M

COMPASS 1 2Z8 S03 3.50-2M

Dati punti luce

Rendimento punto luce : 100%
Rendimento punto luce : 129.71 lm/W
Classificazione : A30 ↓100.0% ↑0.0%
CIE Flux Codes : 36 74 98 100 100
UGR 4H 8H : 41.4 / 21.2
Potenza : 51.5 W
Flusso luminoso : 6680 lm

Sorgenti:

Quantità : 1
Nome : L-COM-2Z8-3000-500-2M-
Temp. Di Colore : 3000
Flusso luminoso : 6680 lm
Resa cromatica : 70

Dimensioni : Ø540 mm x 85 mm

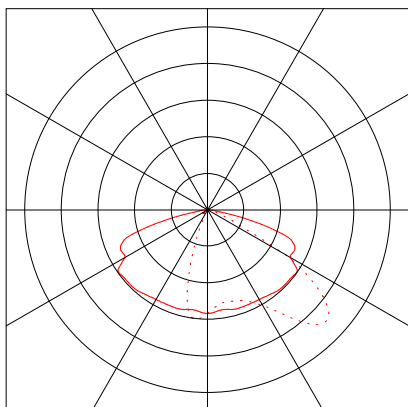

Oggetto : PUBBLICA ILLUMINAZIONE
Impianto : VENEZIA
Numero progetto : 471a -22
Data : 09.11.2022

1 Dati punti luce

1.6 AEC ILLUMINAZIONE SRL, ITALO 1 0F6 OP-DX 4.5-... (ITALO 1 0F6 OP-...)

1.6.1 Pagina dati

Marca: AEC ILLUMINAZIONE SRL

ITALO 1 0F6 OP-DX 4.5-2M

ITALO 1 0F6 OP-DX 4.5-2M

Dati punti luce

Rendimento punto luce : 100%
Rendimento punto luce : 130.92 lm/W
Classificazione : A40 ↓100.0% ↑0.0%
CIE Flux Codes : 45 81 99 100 100
UGR 4H 8H : 34.0 / <10.0
Potenza : 76 W
Flusso luminoso : 9950 lm

Sorgenti:

Quantità : 1
Nome : L-IT1-0F6-4000-525-2M-70
Temp. Di Colore : 4000
Flusso luminoso : 9950 lm
Resa cromatica : 70

Dimensioni : 615 mm x 343 mm x 106 mm

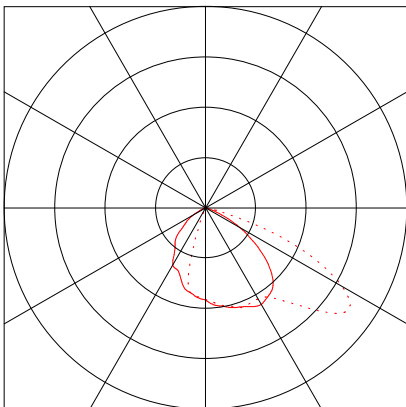

Oggetto : PUBBLICA ILLUMINAZIONE
Impianto : VENEZIA
Numero progetto : 471a -22
Data : 09.11.2022

1 Dati punti luce

1.7 AEC ILLUMINAZIONE SRL, ITALO 1 0F6 OP-SX 3.5-... (ITALO 1 0F6 OP-...)

1.7.1 Pagina dati

Marca: AEC ILLUMINAZIONE SRL

ITALO 1 0F6 OP-SX 3.5-1M

ITALO 1 0F6 OP-SX 3.5-1M

Dati punti luce

Rendimento punto luce : 100%
Rendimento punto luce : 123.08 lm/W
Classificazione : A40 ↓100.0% ↑0.0%
CIE Flux Codes : 45 81 99 100 100
UGR 4H 8H : 27.6 / <10.0
Potenza : 39 W
Flusso luminoso : 4800 lm

Sorgenti:

Quantità : 1
Nome : L-IT1-0F6-3000-525-1M-70
Temp. Di Colore : 3000
Flusso luminoso : 4800 lm
Resa cromatica : 70

Dimensioni : 615 mm x 343 mm x 106 mm

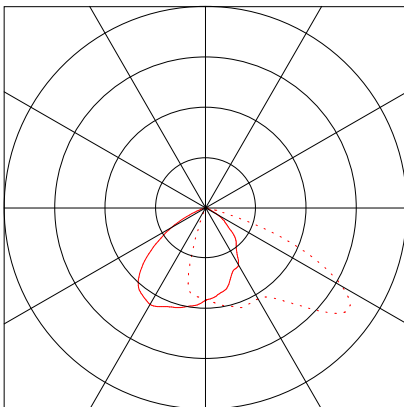

Oggetto : PUBBLICA ILLUMINAZIONE
Impianto : VENEZIA
Numero progetto : 471a -22
Data : 09.11.2022

1 Dati punti luce

1.8 AEC ILLUMINAZIONE SRL, ITALO 1 0F6 OP-DX 3.5-... (ITALO 1 0F6 OP-...)

1.8.1 Pagina dati

Marca: AEC ILLUMINAZIONE SRL

ITALO 1 0F6 OP-DX 3.5-1M

ITALO 1 0F6 OP-DX 3.5-1M

Dati punti luce

Rendimento punto luce : 100%
Rendimento punto luce : 123.08 lm/W
Classificazione : A40 ↓100.0% ↑0.0%
CIE Flux Codes : 45 81 99 100 100
UGR 4H 8H : 33.8 / <10.0
Potenza : 39 W
Flusso luminoso : 4800 lm

Sorgenti:

Quantità : 1
Nome : L-IT1-0F6-3000-525-1M-70
Temp. Di Colore : 3000
Flusso luminoso : 4800 lm
Resa cromatica : 70

Dimensioni : 615 mm x 343 mm x 106 mm

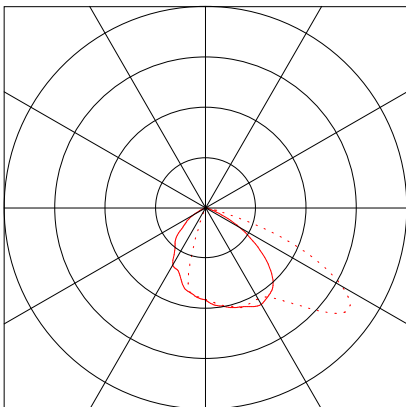

Oggetto : PUBBLICA ILLUMINAZIONE
Impianto : VENEZIA
Numero progetto : 471a -22
Data : 09.11.2022

1 Dati punti luce

1.9 AEC ILLUMINAZIONE SRL, Galileo 1 0F6 ASC-4W 3... (Galileo 1 0F6 A...)

1.9.1 Pagina dati

Marca: AEC ILLUMINAZIONE SRL

Galileo 1 0F6 ASC-4W 3.7-2M

Galileo 1 0F6 ASC-4W 3.7-2M

Dati punti luce

Rendimento punto luce : 100%
Rendimento punto luce : 114.9 lm/W
Classificazione : A50 ↓100.0% ↑0.0%
CIE Flux Codes : 62 90 99 100 100
UGR 4H 8H : 30.8 / 15.7
Potenza : 102 W
Flusso luminoso : 11720 lm

Sorgenti:

Quantità : 1
Nome : L-GAL1-0F6-3000-700-2M-...
Temp. Di Colore : 3000
Flusso luminoso : 11720 lm
Resa cromatica : 70

Dimensioni : 231 mm x 437 mm x 192 mm

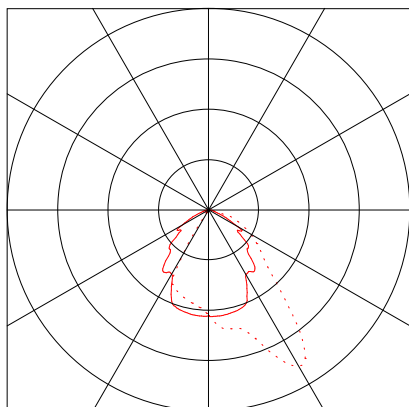

Oggetto : PUBBLICA ILLUMINAZIONE
Impianto : VENEZIA
Numero progetto : 471a -22
Data : 09.11.2022

1 Dati punti luce

1.10 AEC ILLUMINAZIONE SRL, Galileo 1 0F6 ASC-5W 3... (Galileo 1 0F6 A...)

1.10.1 Pagina dati

Marca: AEC ILLUMINAZIONE SRL

Galileo 1 0F6 ASC-5W 3.7-3M

Galileo 1 0F6 ASC-5W 3.7-3M

Dati punti luce

Rendimento punto luce : 100%
Rendimento punto luce : 112.8 lm/W
Classificazione : A50 ↓100.0% ↑0.0%
CIE Flux Codes : 53 89 99 100 100
UGR 4H 8H : 31.3 / 12.9
Potenza : 150 W
Flusso luminoso : 16920 lm

Sorgenti:

Quantità : 1
Nome : L-GAL1-0F6-3000-700-3M-
Temp. Di Colore : 3000
Flusso luminoso : 16920 lm
Resa cromatica : 70

Dimensioni : 231 mm x 437 mm x 192 mm

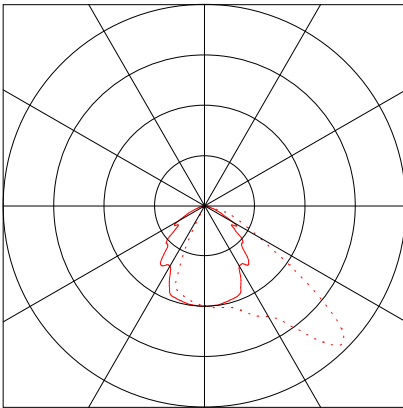

Oggetto : PUBBLICA ILLUMINAZIONE
Impianto : VENEZIA
Numero progetto : 471a -22
Data : 09.11.2022

1 Dati punti luce

1.11 AEC ILLUMINAZIONE SRL, Galileo 1 0F6 ASC-6W 3... (Galileo 1 0F6 A...)

1.11.1 Pagina dati

Marca: AEC ILLUMINAZIONE SRL

Galileo 1 0F6 ASC-6W 3.7-3M

Galileo 1 0F6 ASC-6W 3.7-3M

Dati punti luce

Rendimento punto luce : 100%
Rendimento punto luce : 111.13 lm/W
Classificazione : A40 ↓100.0% ↑0.0%
CIE Flux Codes : 45 79 98 100 100
UGR 4H 8H : 31.8 / 13.5
Potenza : 150 W
Flusso luminoso : 16670 lm

Sorgenti:

Quantità : 1
Nome : L-GAL1-0F6-3000-700-3M-
Temp. Di Colore : 3000
Flusso luminoso : 16670 lm
Resa cromatica : 70

Dimensioni : 231 mm x 437 mm x 192 mm

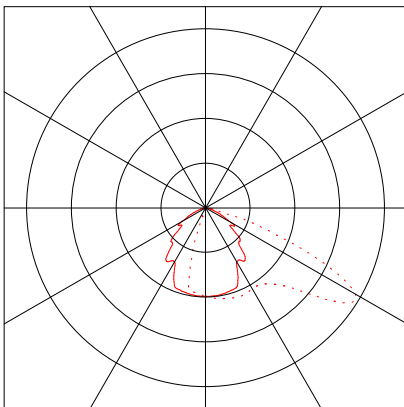

Oggetto : PUBBLICA ILLUMINAZIONE
Impianto : VENEZIA
Numero progetto : 471a -22
Data : 09.11.2022

1 Dati punti luce

1.12 AEC ILLUMINAZIONE SRL, Galileo 1 0F6 ASC-7W 3... (Galileo 1 0F6 A...)

1.12.1 Pagina dati

Marca: AEC ILLUMINAZIONE SRL

Galileo 1 0F6 ASC-7W 3.7-3M

Galileo 1 0F6 ASC-7W 3.7-3M

Dati punti luce

Rendimento punto luce : 100%
Rendimento punto luce : 109.47 lm/W
Classificazione : A40 ↓100.0% ↑0.0%
CIE Flux Codes : 43 71 96 100 100
UGR 4H 8H : 31.2 / 16.6
Potenza : 150 W
Flusso luminoso : 16420 lm

Sorgenti:

Quantità : 1
Nome : L-GAL1-0F6-3000-700-3M-
Temp. Di Colore : 3000
Flusso luminoso : 16420 lm
Resa cromatica : 70

Dimensioni : 231 mm x 437 mm x 71 mm

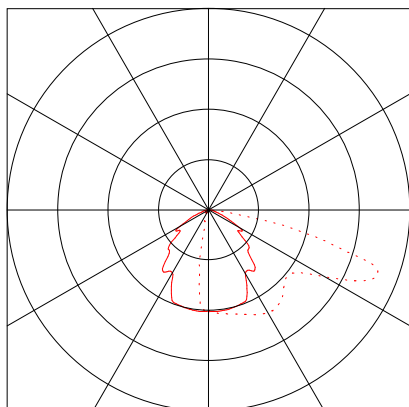

Oggetto : PUBBLICA ILLUMINAZIONE
Impianto : VENEZIA
Numero progetto : 471a -22
Data : 09.11.2022

1 Dati punti luce

1.13 AEC ILLUMINAZIONE SRL, Galileo 1 0F6 ASC-4W 3... (Galileo 1 0F6 A...)

1.13.1 Pagina dati

Marca: AEC ILLUMINAZIONE SRL

Galileo 1 0F6 ASC-4W 3.7-3M

Galileo 1 0F6 ASC-4W 3.7-3M

Dati punti luce

Rendimento punto luce : 100%
Rendimento punto luce : 114.87 lm/W
Classificazione : A50 ↓100.0% ↑0.0%
CIE Flux Codes : 62 90 99 100 100
UGR 4H 8H : 30.7 / 15.6
Potenza : 150 W
Flusso luminoso : 17230 lm

Sorgenti:

Quantità : 1
Nome : L-GAL1-0F6-3000-700-3M-
Temp. Di Colore : 3000
Flusso luminoso : 17230 lm
Resa cromatica : 70

Dimensioni : 231 mm x 437 mm x 192 mm

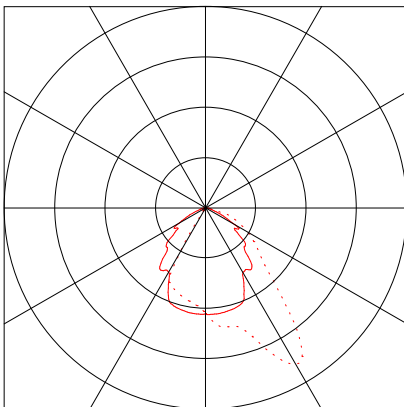

Oggetto : PUBBLICA ILLUMINAZIONE
Impianto : VENEZIA
Numero progetto : 471a -22
Data : 09.11.2022

1 Dati punti luce

1.14 AEC ILLUMINAZIONE SRL, Galileo 1 0F6 ASC-5W 3... (Galileo 1 0F6 A...)

1.14.1 Pagina dati

Marca: AEC ILLUMINAZIONE SRL

Galileo 1 0F6 ASC-5W 3.7-3M

Galileo 1 0F6 ASC-5W 3.7-3M

Dati punti luce

Rendimento punto luce : 100%
Rendimento punto luce : 112.8 lm/W
Classificazione : A50 ↓100.0% ↑0.0%
CIE Flux Codes : 53 89 99 100 100
UGR 4H 8H : 31.3 / 12.9
Potenza : 150 W
Flusso luminoso : 16920 lm

Sorgenti:

Quantità : 1
Nome : L-GAL1-0F6-3000-700-3M-
Temp. Di Colore : 3000
Flusso luminoso : 16920 lm
Resa cromatica : 70

Dimensioni : 231 mm x 437 mm x 192 mm

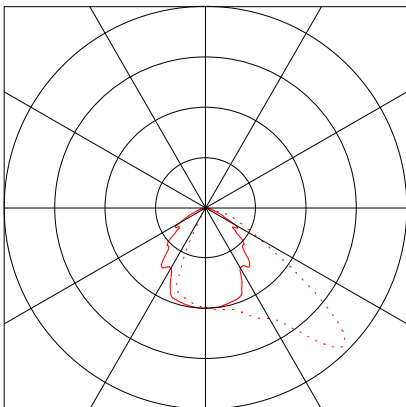

Oggetto : PUBBLICA ILLUMINAZIONE
Impianto : VENEZIA
Numero progetto : 471a -22
Data : 09.11.2022

1 Dati punti luce

1.15 AEC ILLUMINAZIONE SRL, Galileo 1 0F6 ASC-5W 3... (Galileo 1 0F6 A...)

1.15.1 Pagina dati

Marca: AEC ILLUMINAZIONE SRL

Galileo 1 0F6 ASC-5W 3.7-3M

Galileo 1 0F6 ASC-5W 3.7-3M

Dati punti luce

Rendimento punto luce : 100%
Rendimento punto luce : 112.8 lm/W
Classificazione : A50 ↓100.0% ↑0.0%
CIE Flux Codes : 53 89 99 100 100
UGR 4H 8H : 31.3 / 12.9
Potenza : 150 W
Flusso luminoso : 16920 lm

Sorgenti:

Quantità : 1
Nome : L-GAL1-0F6-3000-700-3M-...
Temp. Di Colore : 3000
Flusso luminoso : 16920 lm
Resa cromatica : 70

Dimensioni : 231 mm x 437 mm x 192 mm

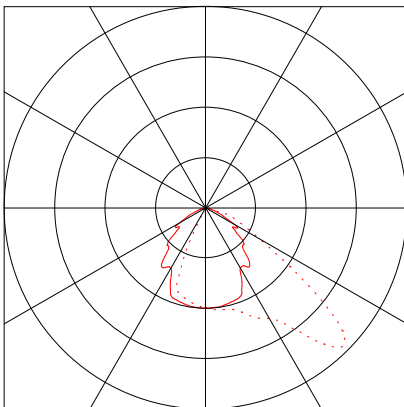

Oggetto : PUBBLICA ILLUMINAZIONE
Impianto : VENEZIA
Numero progetto : 471a -22
Data : 09.11.2022

1 Dati punti luce

1.16 AEC ILLUMINAZIONE SRL, ECO RAYS TP 0F2H1 S05 ... (ECO RAYS TP 0F2...)

1.16.1 Pagina dati

Marca: AEC ILLUMINAZIONE SRL

ECO RAYS TP 0F2H1 S05 3.5-1M

ECO RAYS TP 0F2H1 S05 3.5-1M

Dati punti luce

Rendimento punto luce : 100%
Rendimento punto luce : 106.25 lm/W
Classificazione : A30 ↓100.0% ↑0.0%
CIE Flux Codes : 27 66 97 100 100
UGR 4H 8H : 39.4 / 25.5
Potenza : 16 W
Flusso luminoso : 1700 lm

Sorgenti:

Quantità : 1
Nome : L-ECR-0F2H1-3000-525-1
Temp. Di Colore : 3000
Flusso luminoso : 1700 lm
Resa cromatica : 70

Dimensioni : Ø497 mm x 665 mm

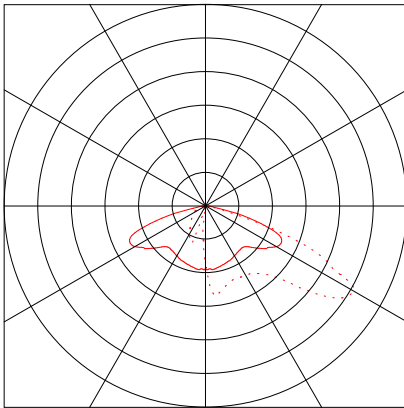

Oggetto : PUBBLICA ILLUMINAZIONE
Impianto : VENEZIA
Numero progetto : 471a -22
Data : 09.11.2022

1 Dati punti luce

1.17 AEC ILLUMINAZIONE SRL, COMPASS 1 2Z8 STU-M 3.... (COMPASS 1 2Z8 S...)

1.17.1 Pagina dati

Marca: AEC ILLUMINAZIONE SRL

COMPASS 1 2Z8 STU-M 3.50-2M

COMPASS 1 2Z8 STU-M 3.50-2M

Dati punti luce

Rendimento punto luce : 100%
Rendimento punto luce : 132.43 lm/W
Classificazione : A30 ↓100.0% ↑0.0%
CIE Flux Codes : 43 75 97 100 100
UGR 4H 8H : 43.8 / 19.6
Potenza : 51.5 W
Flusso luminoso : 6820 lm

Sorgenti:

Quantità : 1
Nome : L-COM-2Z8-3000-500-2M-
Temp. Di Colore : 3000
Flusso luminoso : 6820 lm
Resa cromatica : 70

Dimensioni : Ø540 mm x 85 mm

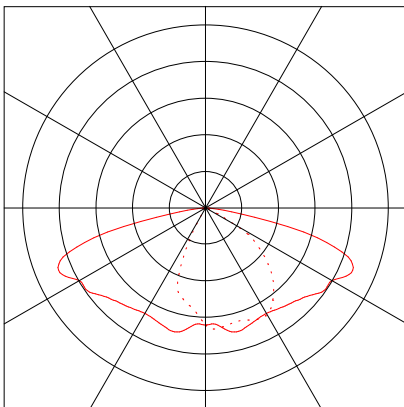

Oggetto : PUBBLICA ILLUMINAZIONE
Impianto : VENEZIA
Numero progetto : 471a -22
Data : 09.11.2022

1 Dati punti luce

1.18 AEC ILLUMINAZIONE SRL, COMPASS 1 2Z8 STU-W 3.... (COMPASS 1 2Z8 S...)

1.18.1 Pagina dati

Marca: AEC ILLUMINAZIONE SRL

COMPASS 1 2Z8 STU-W 3.50-2M

COMPASS 1 2Z8 STU-W 3.50-2M

Dati punti luce

Rendimento punto luce : 100%
Rendimento punto luce : 132.43 lm/W
Classificazione : A30 ↓100.0% ↑0.0%
CIE Flux Codes : 39 74 97 100 100
UGR 4H 8H : 42.6 / 21.0
Potenza : 51.5 W
Flusso luminoso : 6820 lm

Sorgenti:

Quantità : 1
Nome : L-COM-2Z8-3000-500-2M-
Temp. Di Colore : 3000
Flusso luminoso : 6820 lm
Resa cromatica : 70

Dimensioni : Ø540 mm x 85 mm

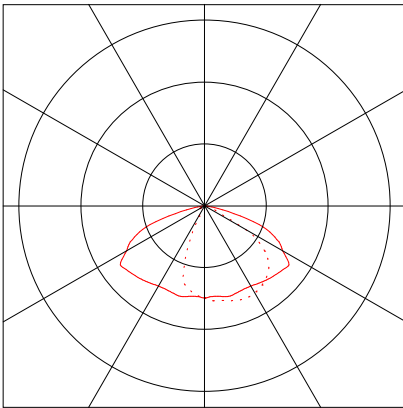

Oggetto : PUBBLICA ILLUMINAZIONE
Impianto : VENEZIA
Numero progetto : 471a -22
Data : 09.11.2022

1 Dati punti luce

1.19 AEC ILLUMINAZIONE SRL, COMPASS 1 2Z8 STU-W 3.... (COMPASS 1 2Z8 S...)

1.19.1 Pagina dati

Marca: AEC ILLUMINAZIONE SRL

COMPASS 1 2Z8 STU-W 3.40-2M

COMPASS 1 2Z8 STU-W 3.40-2M

Dati punti luce

Rendimento punto luce : 100%
Rendimento punto luce : 138.02 lm/W
Classificazione : A30 ↓100.0% ↑0.0%
CIE Flux Codes : 39 74 97 100 100
UGR 4H 8H : 41.9 / 20.3
Potenza : 40.5 W
Flusso luminoso : 5590 lm

Sorgenti:

Quantità : 1
Nome : L-COM-2Z8-3000-400-2M-
Temp. Di Colore : 3000
Flusso luminoso : 5590 lm
Resa cromatica : 70

Dimensioni : Ø540 mm x 85 mm

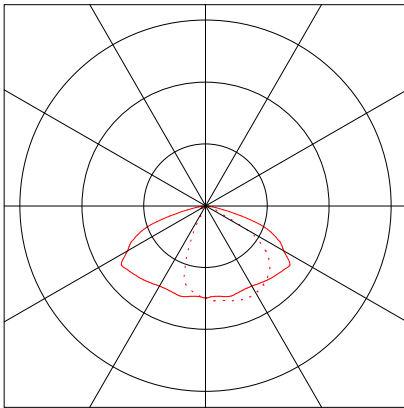

Oggetto : PUBBLICA ILLUMINAZIONE
Impianto : VENEZIA
Numero progetto : 471a -22
Data : 09.11.2022

1 Dati punti luce

1.20 AEC ILLUMINAZIONE SRL, COMPASS 1 2Z8 STU-M 3.... (COMPASS 1 2Z8 S...)

1.20.1 Pagina dati

Marca: AEC ILLUMINAZIONE SRL

COMPASS 1 2Z8 STU-M 3.40-2M

COMPASS 1 2Z8 STU-M 3.40-2M

Dati punti luce

Rendimento punto luce : 100%
Rendimento punto luce : 138.02 lm/W
Classificazione : A30 ↓100.0% ↑0.0%
CIE Flux Codes : 43 75 97 100 100
UGR 4H 8H : 43.1 / 19.0
Potenza : 40.5 W
Flusso luminoso : 5590 lm

Sorgenti:

Quantità : 1
Nome : L-COM-2Z8-3000-400-2M-
Temp. Di Colore : 3000
Flusso luminoso : 5590 lm
Resa cromatica : 70

Dimensioni : Ø540 mm x 85 mm

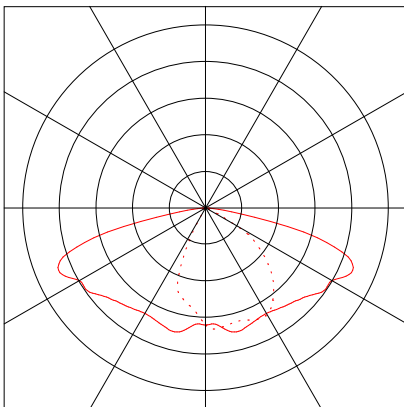

Oggetto : PUBBLICA ILLUMINAZIONE
Impianto : VENEZIA
Numero progetto : 471a -22
Data : 09.11.2022

1 Dati punti luce

1.21 AEC ILLUMINAZIONE SRL, ITALO 1 0F6 OP-DX 3.5-... (ITALO 1 0F6 OP-...)

1.21.1 Pagina dati

Marca: AEC ILLUMINAZIONE SRL

ITALO 1 0F6 OP-DX 3.5-2M

ITALO 1 0F6 OP-DX 3.5-2M

Dati punti luce

Rendimento punto luce : 100%
Rendimento punto luce : 121.71 lm/W
Classificazione : A40 ↓100.0% ↑0.0%
CIE Flux Codes : 45 81 99 100 100
UGR 4H 8H : 33.7 / <10.0
Potenza : 76 W
Flusso luminoso : 9250 lm

Sorgenti:

Quantità : 1
Nome : L-IT1-0F6-3000-525-2M-70
Temp. Di Colore : 3000
Flusso luminoso : 9250 lm
Resa cromatica : 70

Dimensioni : 615 mm x 343 mm x 106 mm

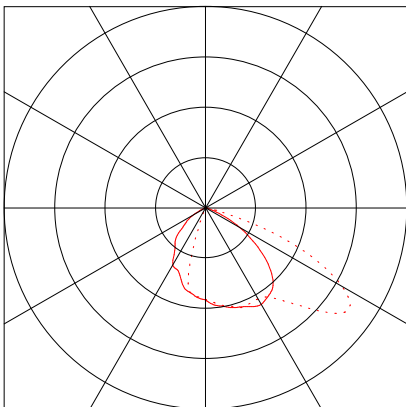

Oggetto : PUBBLICA ILLUMINAZIONE
Impianto : VENEZIA
Numero progetto : 471a -22
Data : 09.11.2022



2 Impianto esterno 1

2.1 Descrizione, Impianto esterno 1

2.1.1 Dati punti luce/Elementi dell' interno

Dati prodotti:

Tipo Num. Marca

		AEC ILLUMINAZIONE SRL	
3	3 x	Codice	: ECO RAYS TP 0F2H1 STU-S 3.5-1M
		Nome punto luce	: ECO RAYS TP 0F2H1 STU-S 3.5-1M
		Sorgenti	: 1 x L-ECR-0F2H1-3000-525-1M-70-25 16 W / 1660 lm
16	6 x	Codice	: ECO RAYS TP 0F2H1 S05 3.5-1M
		Nome punto luce	: ECO RAYS TP 0F2H1 S05 3.5-1M
		Sorgenti	: 1 x L-ECR-0F2H1-3000-525-1M-70-25 16 W / 1700 lm

2 Impianto esterno 1

2.1 Descrizione, Impianto esterno 1

2.1.1 Dati punti luce/Elementi dell' interno

Piano con posizione dell'apparecchio e del sensore:



Nr.	Centro			Angolo di rotazione			Coordinate destinazione		
	X [m]	Y [m]	Z [m]	Z [°]	C0 [°]	C90 [°]	Xa [m]	Ya [m]	Za [m]
AEC ILLUMINAZIONE SRL ECO RAYS TP 0F2H1 STU-S 3.5-1M ECO RAYS TP 0F2H1									
STU-S 3.5-1M									
13	60.83	106.79	4.17	2.42	0.00	0.00	60.83	106.79	0.00
14	85.96	107.77	4.17	2.42	0.00	0.00	85.96	107.77	0.00
15	110.62	108.55	4.17	2.42	0.00	0.00	110.62	108.55	0.00
AEC ILLUMINAZIONE SRL ECO RAYS TP 0F2H1 S05 3.5-1M ECO RAYS TP 0F2H1 S05									
3.5-1M									
4	-12.44	155.22	4.17	247.57	0.00	0.00	-12.44	155.23	0.00
5	-2.87	143.82	4.17	327.13	0.00	0.00	-2.88	143.82	0.00
6	9.87	155.25	4.17	174.93	0.00	0.00	9.87	155.25	0.00
7	-15.79	141.92	4.17	350.15	0.00	0.00	-15.79	141.92	0.00
12	-26.09	140.64	4.17	359.13	0.00	0.00	-26.09	140.64	0.00
16	-21.54	154.98	4.17	120.26	0.00	0.00	-21.54	154.98	0.00

Elementi di creazione

Superficie di misurazione

Nr.	xm[m]	ym[m]	zm[m]	Lungh.	Largh.	Angolo di rotazione		
						Asse Z	Asse L	Asse Q
M 1	-33.48	151.21	0.00	51.81	47.41	64.45	0.00	0.00
M 3	52.70	108.37	0.00	68.20	11.20	87.17	0.00	0.00

Oggetto : PUBBLICA ILLUMINAZIONE
Impianto : VENEZIA
Numero progetto : 471a -22
Data : 09.11.2022

2 Impianto esterno 1

2.1 Descrizione, Impianto esterno 1

2.1.1 Dati punti luce/Elementi dell' interno

2.1 Descrizione, Impianto esterno 1

2.1.2 Pianta

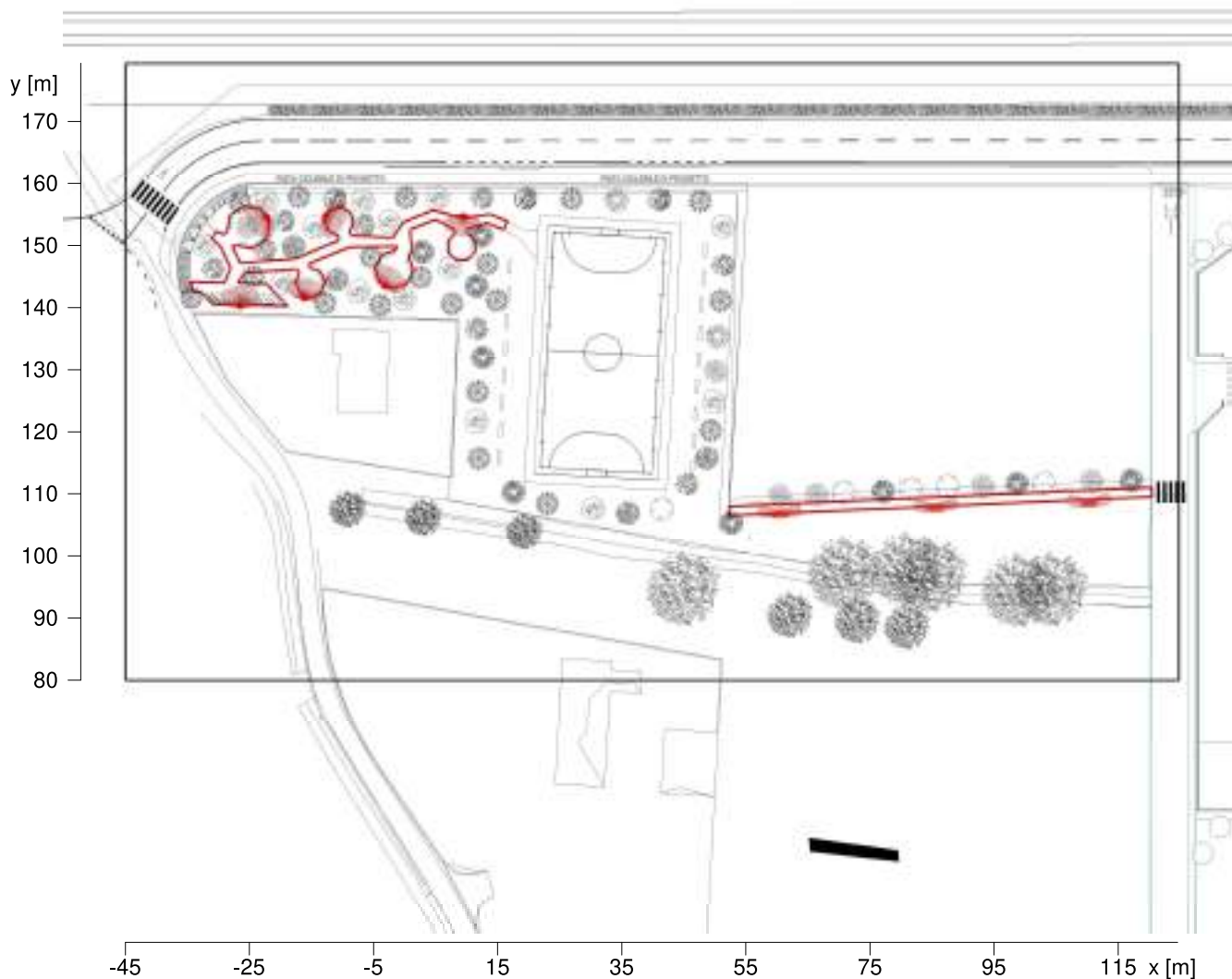

2 Impianto esterno 1

2.2 Risultati calcolo, Impianto esterno 1

2.2.1 Tabella, Suolo (E)

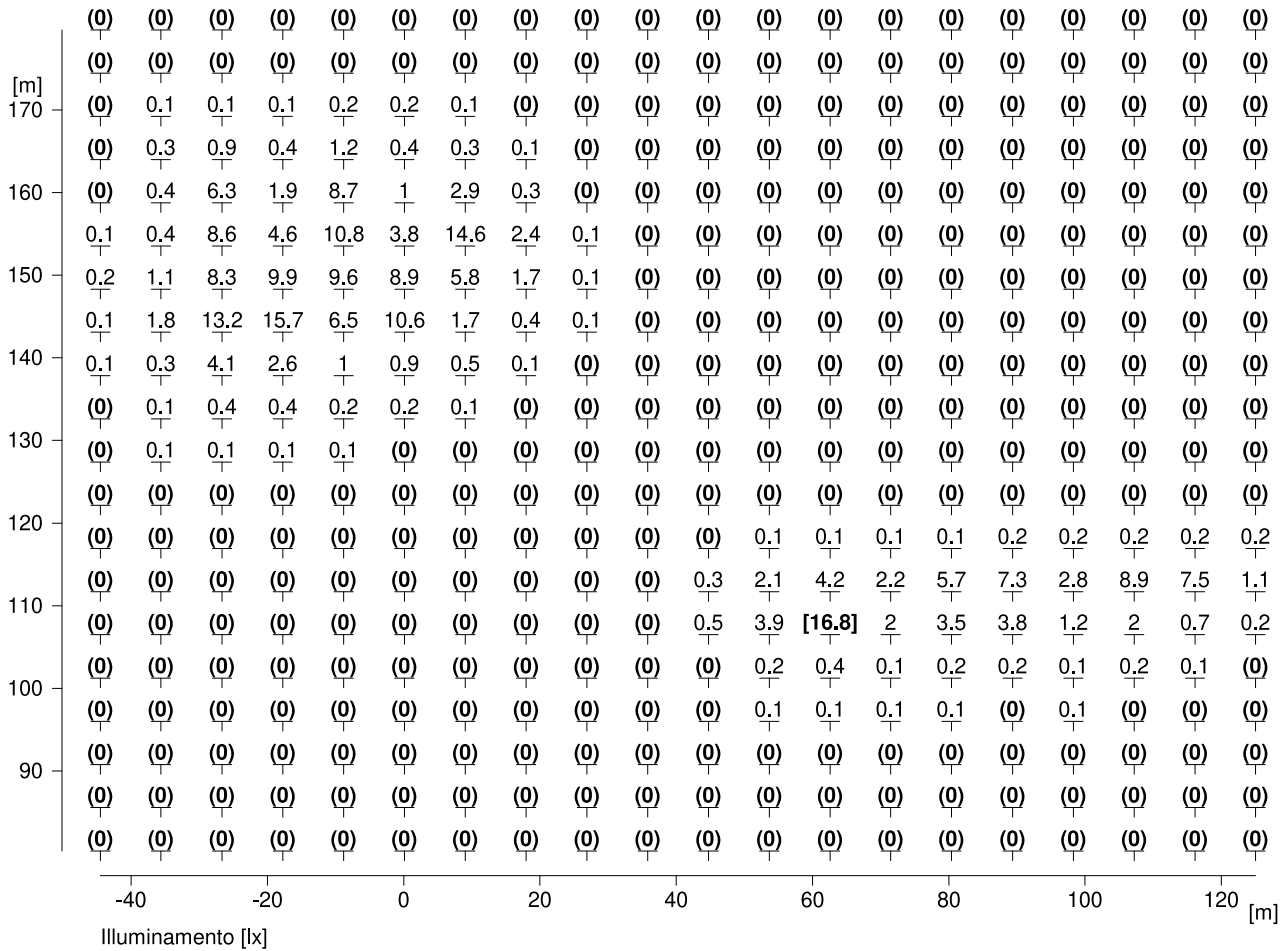

Illuminamento medio Em : 0.7 lx
 Illuminamento minimo Emin : 0 lx
 Illuminamento massimo Emax : 16.8 lx
 Uniformità Uo Emin/Em : ---
 Uniformità Ud Emin/Emax : ---

2.2 Risultati calcolo, Impianto esterno 1

2.2.2 Tabella, Superficie di misurazione 1 (E)

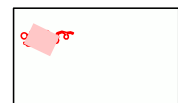
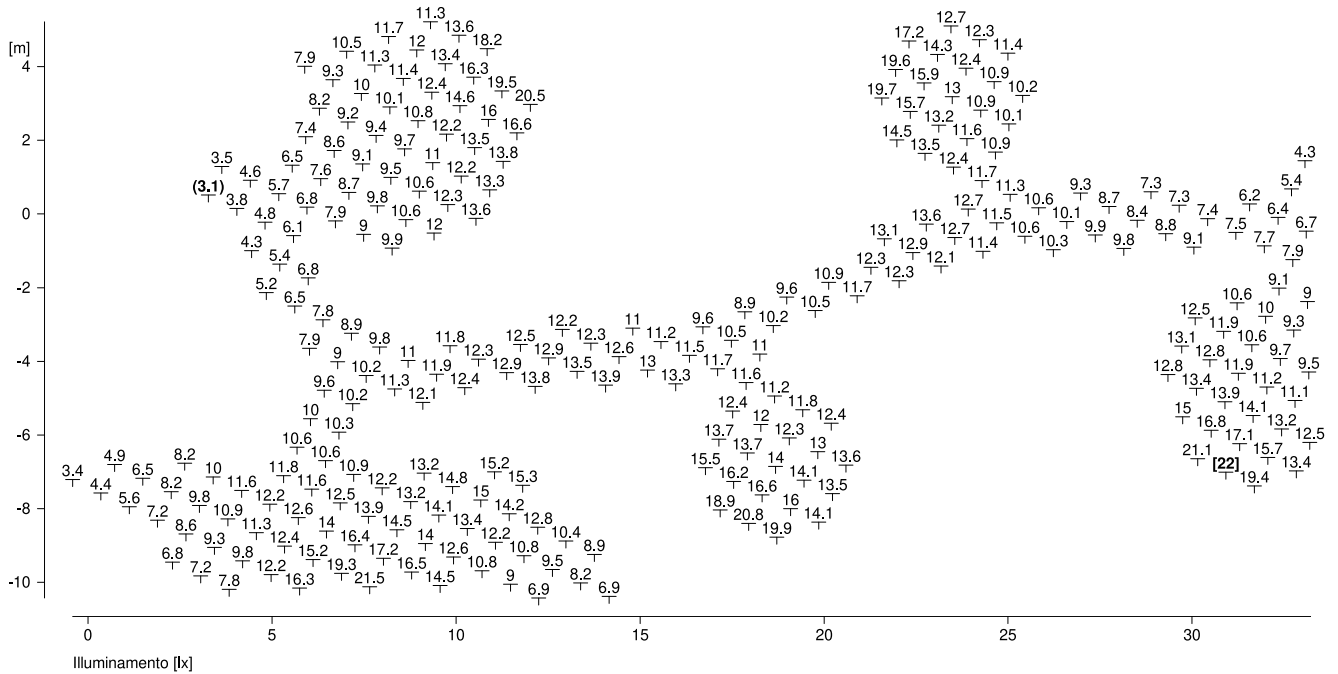

Parte1

Altezza del piano di riferimento	:	0.00 m
Illuminamento medio	Em	: 10.8 lx
Illuminamento minimo	Emin	: 3.1 lx
Illuminamento massimo	Emax	: 22 lx
Uniformità Uo	Emin/Em	: 1 : 3.48 (0.29)
Uniformità Ud	Emin/Emax	: 1 : 7.10 (0.14)

2.2 Risultati calcolo, Impianto esterno 1

2.2.2 Tabella, Superficie di misurazione 1 (E)

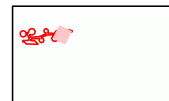
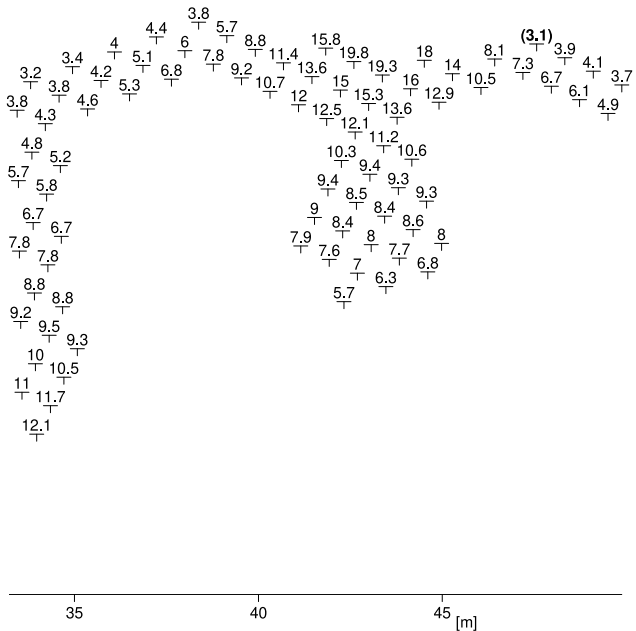

Oggetto : PUBBLICA ILLUMINAZIONE
 Impianto : VENEZIA
 Numero progetto : 471a -22
 Data : 09.11.2022

2.2 Risultati calcolo, Impianto esterno 1

2.2.3 Tabella, Superficie di misurazione 3 (E)

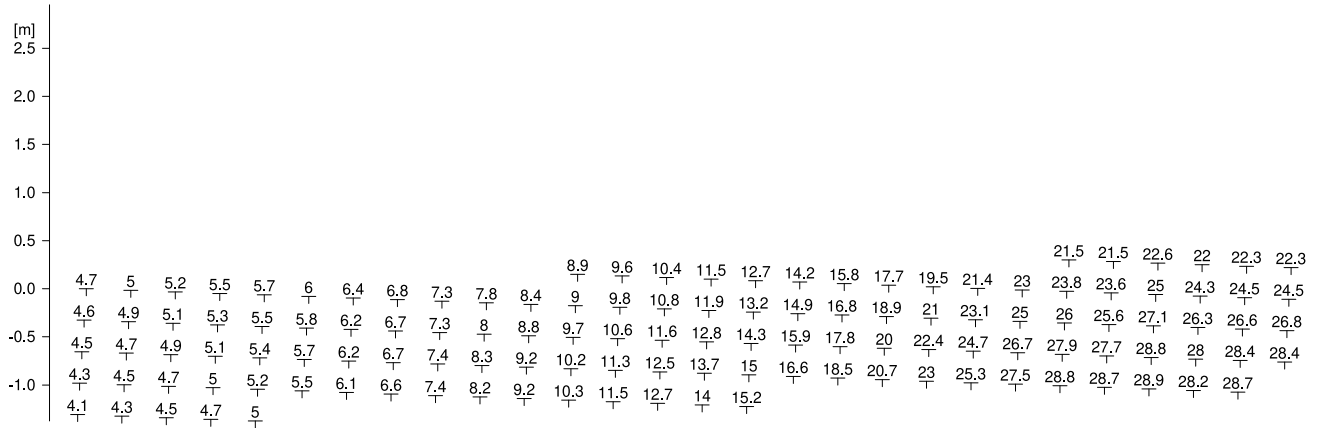

Illuminamento [lx]

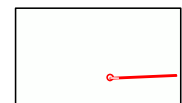

Parte1

Altezza del piano di riferimento	:	0.00 m
Illuminamento medio	Em	: 10.1 lx
Illuminamento minimo	Emin	: 2.9 lx
Illuminamento massimo	Emax	: 29.3 lx
Uniformità Uo	Emin/Em	: 1 : 3.43 (0.29)
Uniformità Ud	Emin/Emax	: 1 : 9.93 (0.10)

2.2 Risultati calcolo, Impianto esterno 1

2.2.3 Tabella, Superficie di misurazione 3 (E)

				14	12,8	11,7	10,7	9,8	9,1	8,5	8	7,5	7,1	6,7	6,5	6,1	5,8	5,6	5,3	5,1	4,9	4,7	4,5	4,3	4,2	4	3,9	3,8	3,7
21,3	19,9	18,4	16,7	15,1	13,6	12,3	11,2	10,3	9,6	9	8,4	7,7	7,1	6,6	6,2	5,9	5,6	5,4	5,2	5	4,8	4,6	4,4	4,3	4,2	4	3,9	3,7	3,6
23,5	21,9	20	18,1	16,3	14,7	13,4	12,3	11,4	10,5	9,7	8,9	8,1	7,3	6,7	6,2	5,8	5,5	5,3	5,1	4,9	4,7	4,5	4,4	4,2	4	3,8	3,7	3,5	3,4
25,6	23,7	21,6	19,5	17,7	16	14,6	13,4	12,3	11,2	10,2	9,2	8,2	7,3	6,7	6,1	5,7	5,4	5,2	4,9	4,7	4,5	4,4	4,2	4	3,8	3,7	3,5	3,4	3,3
27,1	24,9	22,7	20,4	18,3	16,6	15,2	13,9	12,7							6	5,5	5,2	4,9	4,7		4,5	4,4	4,2	4	3,8	3,7	3,5	3,4	3,3

10

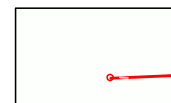

Parte2

2.2 Risultati calcolo, Impianto esterno 1

2.2.3 Tabella, Superficie di misurazione 3 (E)

8,7	9,2	9,9	10,7	11,8	13	14,5	16,2	17,9	18,1	19,6	20,7	20,9	21,4	22	21,5	21,9	21,6	20,6	19,1	16	14,7	13,5	12,3	11,3	10,3	9,6	9	8,4	7,9
8,6	9,2	10	11	12,1	13,6	15,3	17,1	19,3	19,8	21,5	22,9	23,3	23,4	24,5	23,7	24,1	23,9	22,6	20,9	17,6	16	14,4	13,1	11,8	10,8	10	9,3	8,7	8,2
9	9,9	10,7	11,8	13	14,5	16,2	18,2	20,5	21,3	23,4	25	25,4	25,4	26,9	25,7	26,4	26,2	24,7	22,7	20,7	18,7	16,9	15,3	14,1	11,8	11	10,1	9,3	8,5
9,5	10,5	11,5	12,7	14	15,4	17,1	19,1	21,3	23,6	26	28	28,9	28,3	29,3	27,7	28,3	27,9	26,3	24,1	22	19,7	17,7	16,1	14,8	13	11,9	10,8	9,8	8,9
9,6	10,7	11,9	13,1																										

30

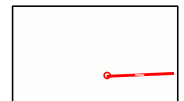

Parte4

2.2 Risultati calcolo, Impianto esterno 1

2.2.3 Tabella, Superficie di misurazione 3 (E)

7.8	7.3	6.9	6.5	6.1	5.9	5.6	5.4	5.1	5	4.8	4.6	4.4	4.3	4.1	4	3.9	3.8	3.7	3.6	3.6	3.5	3.5	3.6	3.6	3.7	3.8	3.9	4	4.1	
7.5	7	6.6	6.2	5.9	5.7	5.5	5.3	5.1	4.9	4.7	4.5	4.4	4.3	4.1	4	3.9	3.8	3.7	3.6	3.5	3.5	3.5	3.5	3.6	3.6	3.7	3.7	3.9	4	4.1
7.5	7	6.5	6.1	5.8	5.5	5.3	5.1	5	4.8	4.6	4.4	4.3	4.2	4.1	3.9	3.8	3.7	3.6	3.5	3.4	3.4	3.4	3.4	3.4	3.5	3.6	3.7	3.8	3.9	4
7.8	7.1	6.6	6	5.7	5.4	5.2	5	4.8	4.6	4.5	4.3	4.3	4.1	4	3.8	3.7	3.6	3.5	3.4	3.3	3.3	3.3	3.3	3.4	3.4	3.5	3.6	3.7	3.8	3.9
8	7.1	6.6	6	5.5	5.3																									

40

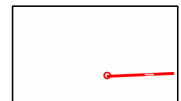

Parte5

2.2 Risultati calcolo, Impianto esterno 1

2.2.3 Tabella, Superficie di misurazione 3 (E)

			4,6	4,8	5,1	5,3	5,6	5,9	6,2	6,4	6,7	7,1	7,4	7,7	8,5	8,7	8,9	9,3	9,8	10,3	11,1	12,1	13,3	14,6	14,7	16	17,3	18,4	18,8	18,7
4,1	4,3	4,4	4,6	4,8	5	5,2	5,4	5,6	5,8	6	6,3	6,7	7	7,4	7,7	8,1	8,6	9	9,6	10,4	11,4	12,6	14	15,6	16,1	17,7	19,2	20,6	21,3	21,1
	4,2	4,4	4,5	4,7	4,9	5,1	5,3	5,4	5,6	5,7	6	6,4	6,8	7,4	7,9	8,4	9	9,8	10,7	11,8	13,1	14,8	16,6	17,5	19,2	21,1	22,7	23,5	23,2	
	4,2	4,3	4,4	4,6	4,8	4,9	5,1	5,2	5,4	5,6	5,9	6,4	6,8	7,4	8,1	8,8	9,6	10,5	11,5	12,7	14,1	15,6	17,5	19,8	22,1	24,4	26,5	27,9	27,5	
	4	4,2	4,3	4,5	4,6	4,7	4,9	5,1																						

50

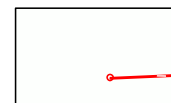

Parte6

Oggetto : PUBBLICA ILLUMINAZIONE
Impianto : VENEZIA
Numero progetto : 471a -22
Data : 09.11.2022

2.2 Risultati calcolo, Impianto esterno 1

2.2.3 Tabella, Superficie di misurazione 3 (E)

$\frac{3,2}{\perp}$	$\frac{3}{\perp}$
$\frac{3,3}{\perp}$	$\frac{3,1}{\perp}$
$\frac{3,3}{\perp}$	$\frac{3,1}{\perp}$
$\frac{3,3}{\perp}$	$\frac{3}{\perp}$
$\frac{3,2}{\perp}$	$\frac{(2,9)}{\perp}$

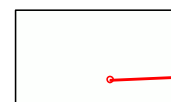

Parte8

2.2 Risultati calcolo, Impianto esterno 1

2.2.4 Tabella, Suolo (L)

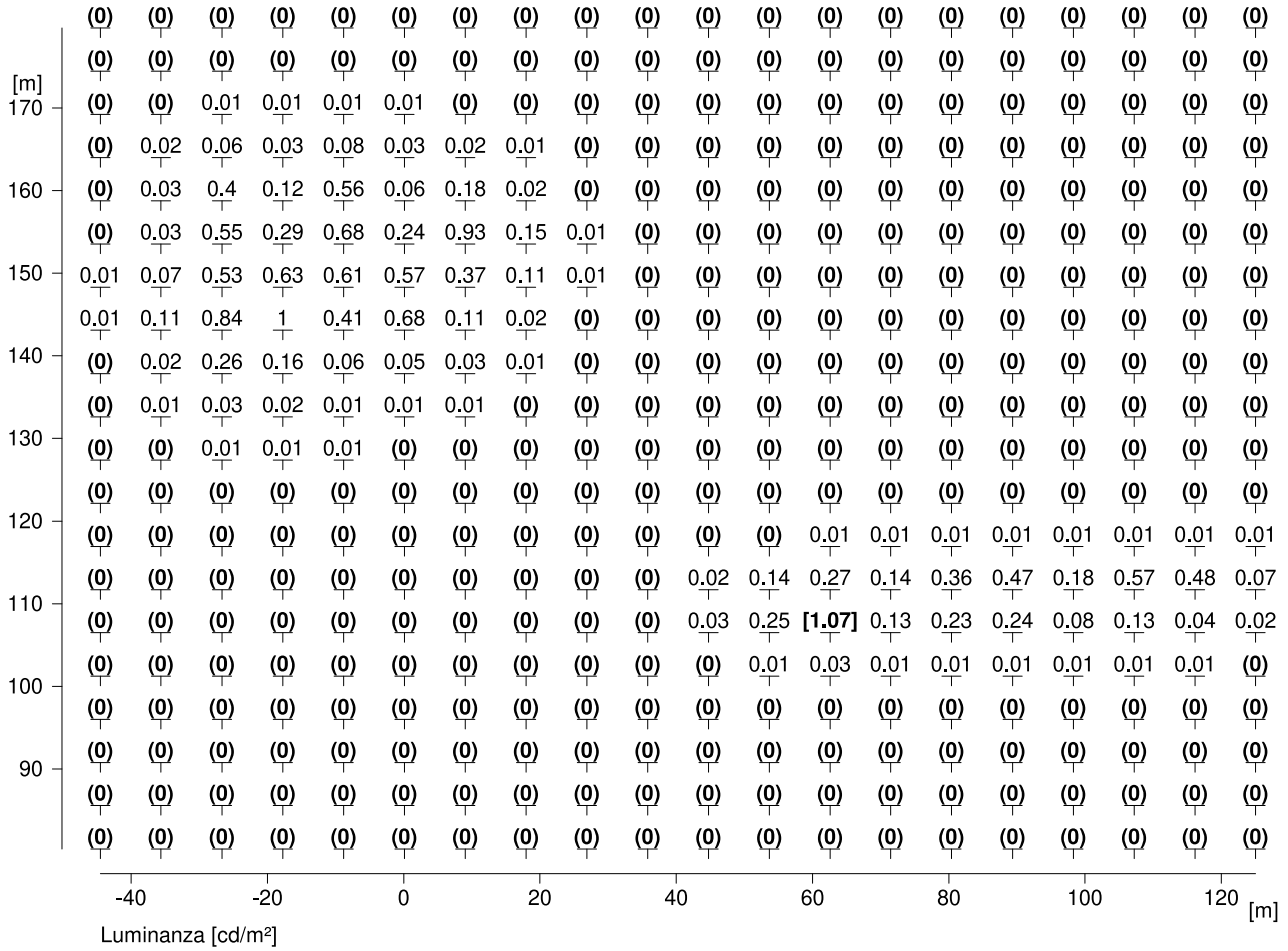

Luminanza media Lm : 0.04 cd/m²
 Luminanza minima Lmin : 0 cd/m²
 Luminanza massima Lmax : 1.07 cd/m²

3 CARREGGATA 1

3.1 Descrizione, CARREGGATA 1

3.1.1 Pianta

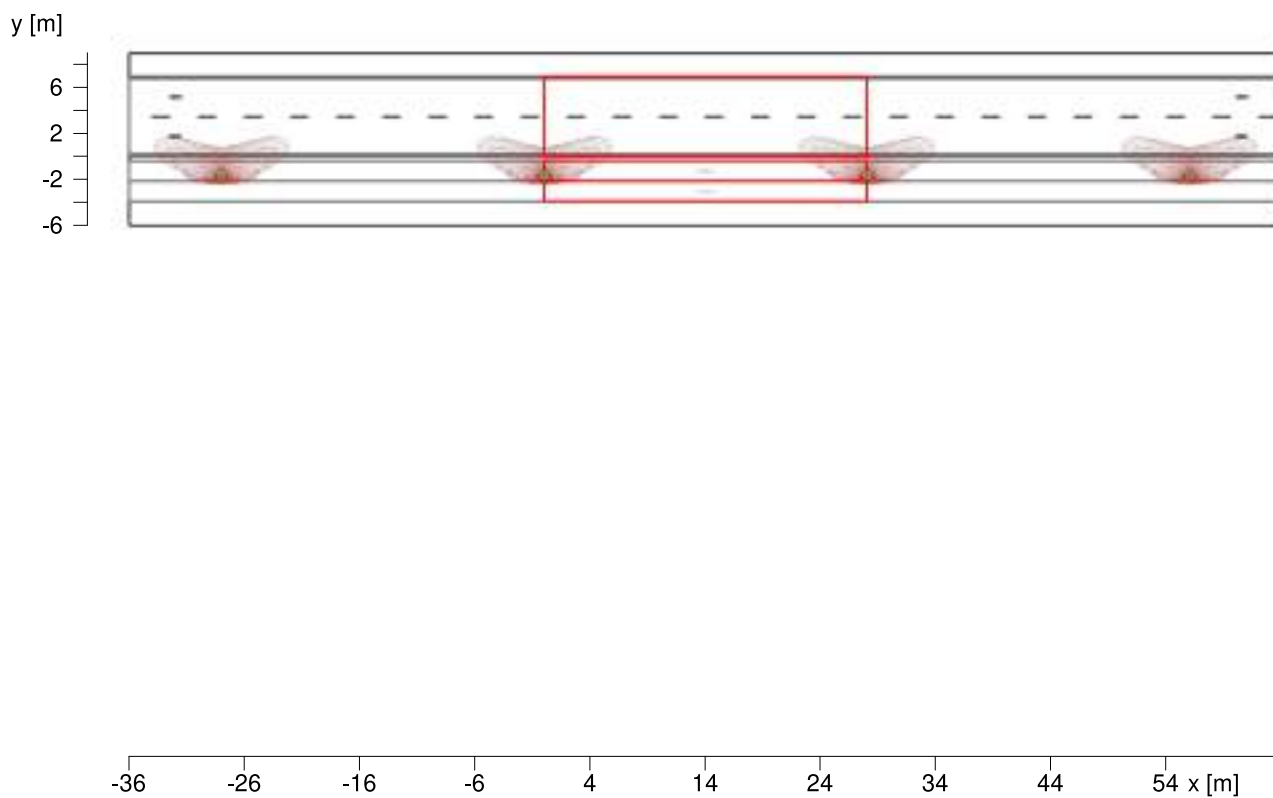

3 CARREGGATA 1

3.2 Riepilogo, CARREGGATA 1

3.2.1 Panoramica risultato, CARREGGATA 1

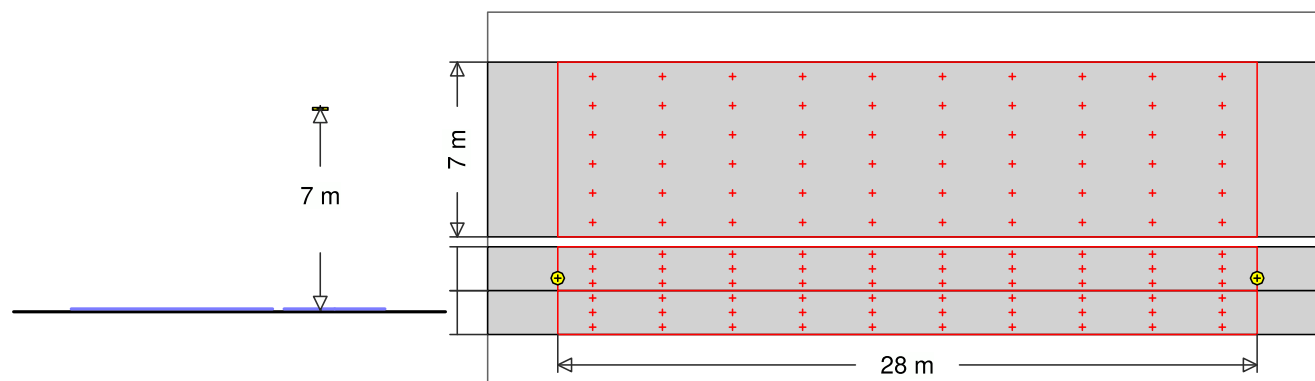

18 AEC ILLUMINAZIONE SRL
 Codice : COMPASS 1 2Z8 STU-W 3.50-2M
 Nome punto luce : COMPASS 1 2Z8 STU-W 3.50-2M
 Sorgenti : 1 x L-COM-2Z8-3000-500-2M-70-25 51.5 W / 6820 lm

MyLumRow

Posizionamento	: Fila a destra	Fattore di manut.	: 0.80
Distanza armature	: 28.00 m	Altezza (centro fotom.)	: 7.00 m
Sporgenza	: -1.65 m	Inclinazione	: 0.00 °
Posizione assoluta	: -1.65 m	Classe di abbaglia.	: D3
Potenza/Km	: 1839 W/km	Classe intensità lum.	: G*3
Flusso verso l'alto (ULR)	0.00		

Strada

Larghezza : 7.00 m Corsie : 2
 Superficie : CIE C2, q0=0.07

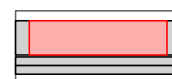

Luminanza

Area di calcolo: 28m x 7m (10 x 6 Punti)

Osservatore

2 : x=88.00m, y=5.25m, z=1.50m

1 : x=-60.00m, y=1.75m, z=1.50m

Lane	\bar{L}_m	U_o	U_I	T_I	Rei
2:(y=5.25)	0.82 cd/m ²	0.47	0.78	7	0.49
1:(y=1.75)	0.75 cd/m ²	0.51	0.72	12	0.97
M4	>= 0.75 cd/m ²	>= 0.40	>= 0.60	<= 15	>= 0.30

Illuminamento

Area di calcolo: 28m x 7m (10 x 6 Punti)

\bar{E}_m	E_{min}	U_o	U_d
13.4 lx	7.89 lx	0.59	0.27

MARCIAPIEDE (Marciapiede, Destra)

Larghezza : 1.75 m
 Distanza dalla strada : 0.40 m Posizione assoluta : -0.40 m

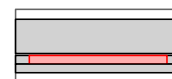

Illuminamento

Area di calcolo: 28m x 1.75m (10 x 3 Punti)

Oggetto : PUBBLICA ILLUMINAZIONE
Impianto : VENEZIA
Numero progetto : 471a -22
Data : 09.11.2022

3 CARREGGAI TA 1

3.2 Riepilogo, CARREGGAI TA 1

3.2.1 Panoramica risultato, CARREGGAI TA 1

	\bar{E}_m	E_{min}	U_o	U_d
	16.3 lx	5.49 lx	0.34	0.17
P2	≥ 10.0 lx	≥ 2.00 lx		

PISTA CICLABILE (Area generica, Destra)

Larghezza : 1.75 m

Distanza dalla strada : 2.15 m

Posizione assoluta : -2.15 m



Illuminamento Area di calcolo: 28m x 1.75m (10 x 3 Punti)

	\bar{E}_m	E_{min}	U_o	U_d
	13.4 lx	3.67 lx	0.27	0.12
P2	≥ 10.0 lx	≥ 2.00 lx		

Oggetto : PUBBLICA ILLUMINAZIONE
Impianto : VENEZIA
Numero progetto : 471a -22
Data : 09.11.2022

4 CARREGGIATA 2

4.1 Descrizione, CARREGGIATA 2

4.1.1 Pianta

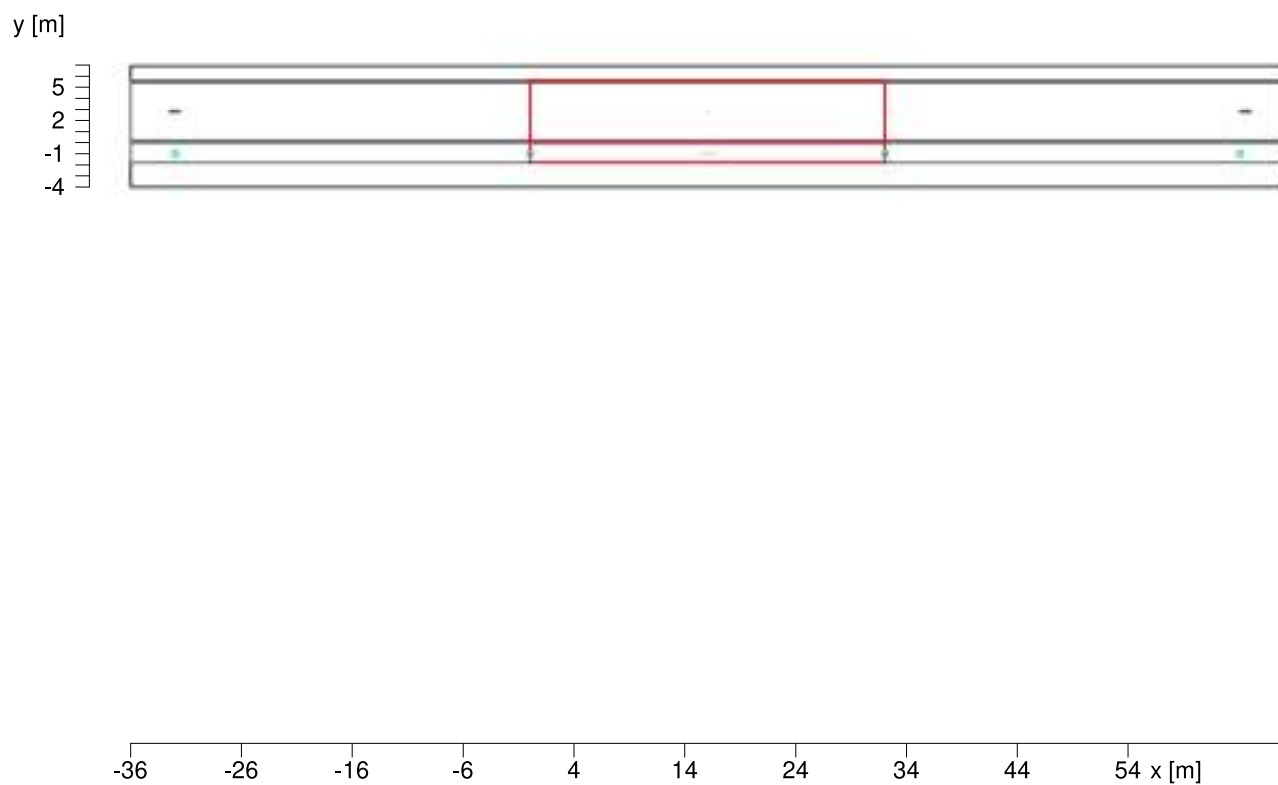

Oggetto : PUBBLICA ILLUMINAZIONE
 Impianto : VENEZIA
 Numero progetto : 471a -22
 Data : 09.11.2022

4 CARREGGIATA 2

4.2 Riepilogo, CARREGGIATA 2

4.2.1 Panoramica risultato, CARREGGIATA 2

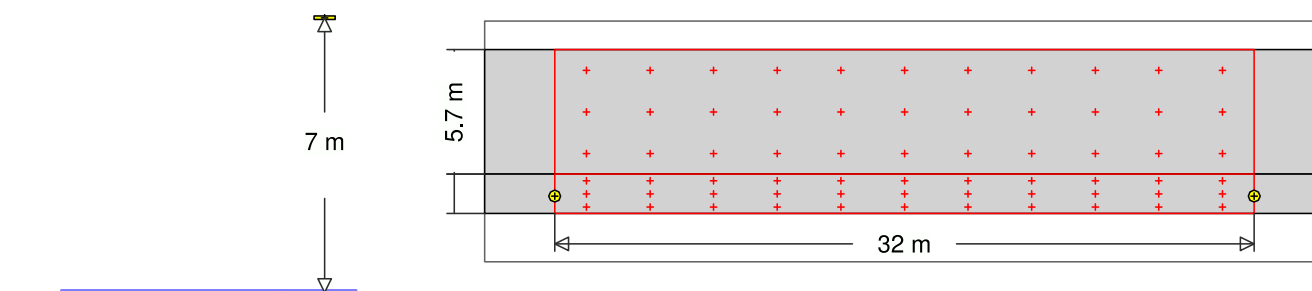

17



AEC ILLUMINAZIONE SRL

Codice : COMPASS 1 2Z8 STU-M 3.50-2M
 Nome punto luce : COMPASS 1 2Z8 STU-M 3.50-2M
 Sorgenti : 1 x L-COM-2Z8-3000-500-2M-70-25 51.5 W / 6820 lm

MyLumRow

Posizionamento	: Fila a destra	Fattore di manut.	: 0.80
Distanza armature	: 32.00 m	Altezza (centro fotom.)	: 7.00 m
Sporgenza	: -1.00 m	Inclinazione	: 0.00 °
Posizione assoluta	: -1.00 m	Classe di abbaglia.	: D1
Potenza/Km	: 1609 W/km	Classe intensità lum.	: G*2
Flusso verso l'alto (ULR)	0.00		

Strada

Larghezza : 5.70 m Corsie : 1
 Superficie : CIE C2, q0=0.07

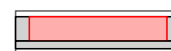

Luminanza

Area di calcolo: 32m x 5.7m (11 x 3 Punti)

Osservatore

1 : x=-60.00m, y=2.85m, z=1.50m

Lane	\bar{L}_m	U_o	U_I	T_I	Rei
1:(y=2.85)	0.93 cd/m ²	0.44	0.61	12	0.30
M4	>= 0.75 cd/m ²	>= 0.40	>= 0.60	<= 15	>= 0.30

Illuminamento

Area di calcolo: 32m x 5.7m (11 x 3 Punti)

\bar{E}_m	E_{min}	U_o	U_d
13.7 lx	5.98 lx	0.44	0.18

MARCIAPIEDE (Marciapiede, Destra)

Larghezza : 1.80 m
 Distanza dalla strada : 0.00 m Posizione assoluta : -0.00 m

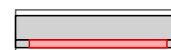

Illuminamento

Area di calcolo: 32m x 1.8m (11 x 3 Punti)

Oggetto : PUBBLICA ILLUMINAZIONE
Impianto : VENEZIA
Numero progetto : 471a -22
Data : 09.11.2022

4 CARREGIATA 2

4.2 Riepilogo, CARREGIATA 2

4.2.1 Panoramica risultato, CARREGIATA 2

	\bar{E}_m	E_{min}	U_o	U_d
	16.7 lx	5.88 lx	0.35	0.16
P2	≥ 10.0 lx	≥ 2.00 lx		

5 CAREGGIATA 3

5.1 Descrizione, CAREGGIATA 3

5.1.1 Pianta

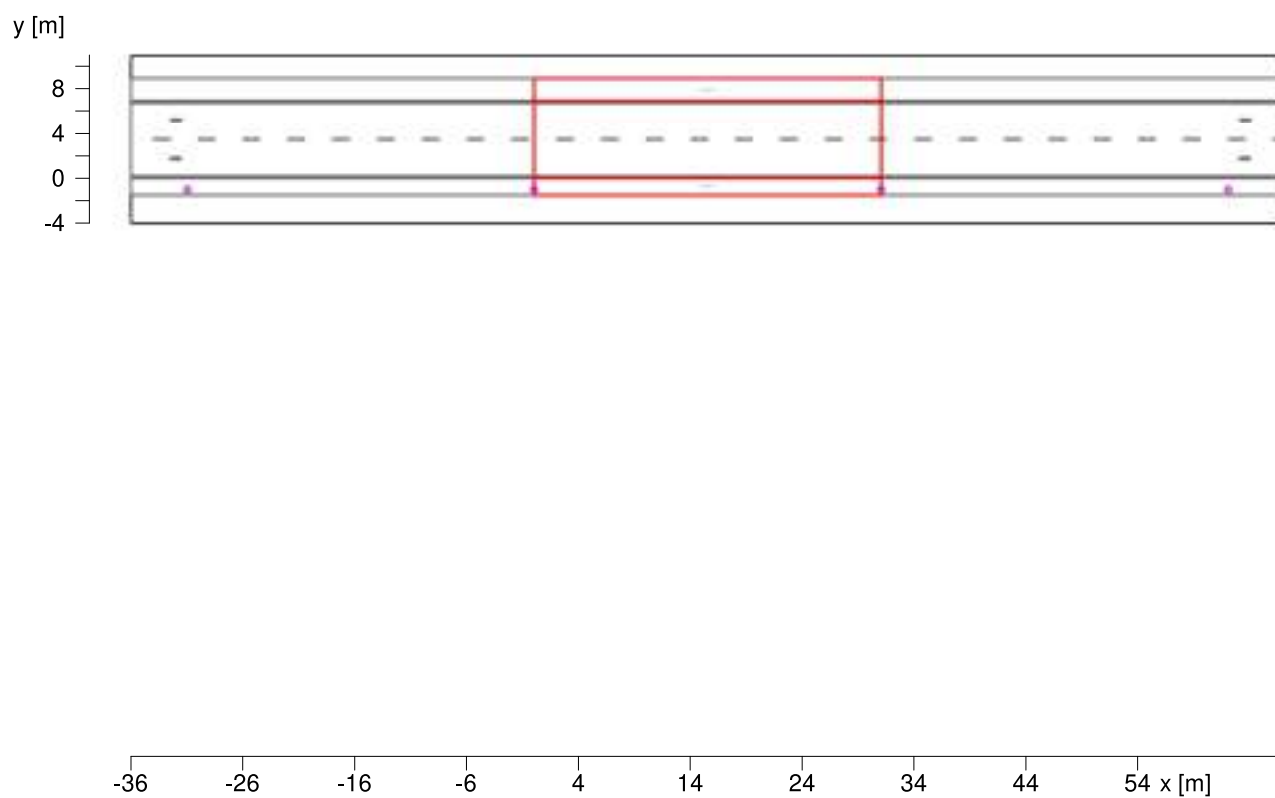

5 CAREGGIATA 3

5.2 Riepilogo, CAREGGIATA 3

5.2.1 Panoramica risultato, CAREGGIATA 3

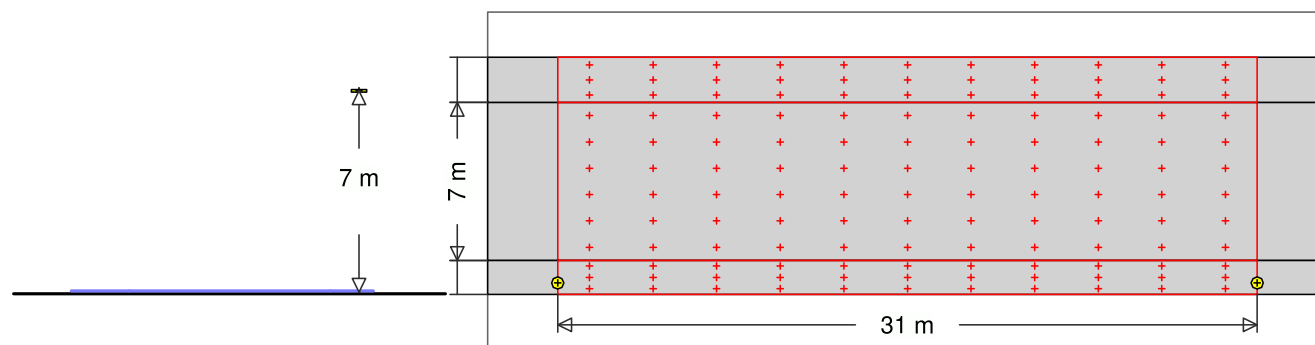

AEC ILLUMINAZIONE SRL

- 1  Codice : COMPASS 1 2Z8 S03 3.40-3M
 Nome punto luce : COMPASS 1 2Z8 S03 3.40-3M
 Sorgenti : 1 x L-COM-2Z8-3000-400-3M-70-25 59.5 W / 8150 lm

MyLumRow

Posizionamento	: Fila a destra	Fattore di manut.	: 0.80
Distanza armature	: 31.00 m	Altezza (centro fotom.)	: 7.00 m
Sporgenza	: -1.00 m	Inclinazione	: 0.00 °
Posizione assoluta	: -1.00 m	Classe di abbaglia.	: D4
Potenza/Km	: 1919 W/km	Classe intensità lum.	: G*4
Flusso verso l'alto (ULR)	0.00		

Strada

Larghezza	: 7.00 m	Corsie	: 2
Superficie	: R3, q0=0.07		

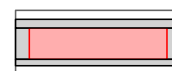

Luminanza

Area di calcolo: 31m x 7m (11 x 6 Punti)

Osservatore

2 : x=91.00m, y=5.25m, z=1.50m

1 : x=-60.00m, y=1.75m, z=1.50m

Lane	\bar{L}_m	U_o	U_I	T_I	Re_i
2:(y=5.25)	0.84 cd/m ²	0.51	0.69	7	0.58
1:(y=1.75)	0.77 cd/m ²	0.53	0.60	12	1.01
M4	>= 0.75 cd/m ²	>= 0.40	>= 0.60	<= 15	>= 0.30

Illuminamento

Area di calcolo: 31m x 7m (11 x 6 Punti)

\bar{E}_m	E_{min}	U_o	U_d
14.4 lx	5.72 lx	0.40	0.19

MARCIAPIEDE (Marciapiede, Sinistra)

Larghezza	: 2.00 m	Posizione assoluta	: 7.00 m
Distanza dalla strada	: 0.00 m		

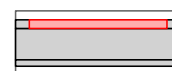

Illuminamento

Area di calcolo: 31m x 2m (11 x 3 Punti)

Oggetto : PUBBLICA ILLUMINAZIONE
Impianto : VENEZIA
Numero progetto : 471a -22
Data : 09.11.2022

5 CAREGGIATA 3

5.2 Riepilogo, CAREGGIATA 3

5.2.1 Panoramica risultato, CAREGGIATA 3

	\bar{E}_m	E_{min}	U_o	U_d
	9.29 lx	5.21 lx	0.56	0.34
P3	≥ 7.50 lx	≥ 1.50 lx		

MARCIAPIEDE (Marciapiede, Destra)

Larghezza : 1.50 m

Distanza dalla strada : 0.00 m

Posizione assoluta : -0.00 m

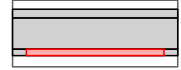

Illuminamento

Area di calcolo: 31m x 1.5m (11 x 3 Punti)

	\bar{E}_m	E_{min}	U_o	U_d
	16.0 lx	4.71 lx	0.29	0.13
P2	≥ 10.0 lx	≥ 2.00 lx		

Oggetto : PUBBLICA ILLUMINAZIONE
Impianto : VENEZIA
Numero progetto : 471a -22
Data : 09.11.2022

6 PASSAGGIO PEDONALE 1 - 3

6.1 Descrizione, PASSAGGIO PEDONALE 1 - 3

6.1.1 Dati punti luce/Elementi dell' interno

Dati prodotti:

Tipo Num. Marca

Tipo	Num.	Marca
		AEC ILLUMINAZIONE SRL
21	2 x	Codice : ITALO 1 0F6 OP-DX 3.5-2M
		Nome punto luce : ITALO 1 0F6 OP-DX 3.5-2M
		Sorgenti : 1 x L-IT1-0F6-3000-525-2M-70-25 76 W / 9250 lm

6 PASSAGGIO PEDONALE 1 - 3

6.1 Descrizione, PASSAGGIO PEDONALE 1 - 3

6.1.1 Dati punti luce/Elementi dell' interno

Piano con posizione dell'apparecchio e del sensore:



Nr.	Centro			Angolo di rotazione			Coordinate destinazione		
	X [m]	Y [m]	Z [m]	Z [°]	C0 [°]	C90 [°]	Xa [m]	Ya [m]	Za [m]
AEC ILLUMINAZIONE SRL ITALO 1 0F6 OP-DX 3.5-2M ITALO 1 0F6 OP-DX 3.5-2M									
1	3.00	1.50	4.95	0.00	0.00	0.00	5.74	1.50	0.20
2	9.00	9.50	4.95	180.00	0.00	0.00	6.26	9.50	0.20

Elementi di creazione

Superficie

Nr.	xm[m]	ym[m]	zm[m]	Lungh.	Largh.	Angolo di rotazione			rho[%]
						Asse Z	Asse L	Asse Q	
Superficie 3									
S 1.3	4.50	7.25	0.00	3.00	0.50	0.00	0.00	0.00	94
Superficie 3									
S 1.11	4.50	8.25	0.00	3.00	0.50	0.00	0.00	0.00	94
Superficie 8									
S 1.8	4.50	6.25	0.00	3.00	0.50	0.00	0.00	0.00	94
Superficie 4									
S 1.4	4.50	5.25	0.00	3.00	0.50	0.00	0.00	0.00	94
Superficie 6									
S 1.6	4.50	4.25	0.00	3.00	0.50	0.00	0.00	0.00	94
Superficie 7									
S 1.7	4.50	3.25	0.00	3.00	0.50	0.00	0.00	0.00	94

Oggetto : PUBBLICA ILLUMINAZIONE
 Impianto : VENEZIA
 Numero progetto : 471a -22
 Data : 09.11.2022

6 PASSAGGIO PEDONALE 1 - 3

6.1 Descrizione, PASSAGGIO PEDONALE 1 - 3

6.1.1 Dati punti luce/Elementi dell' interno

S 1.1	4.50	2.25	0.00	3.00	0.50	0.00	0.00	0.00	94
S 1.10	12.00	6.50	0.00	2.50	2.00	180.00	0.00	0.00	94
S 1.9	-0.00	4.50	0.00	2.50	2.00	0.00	0.00	0.00	94

Superficie di misurazione

Nr.	xm[m]	ym[m]	zm[m]	Lungh.	Largh.	Angolo di rotazione		
						Asse Z	Asse L	Asse Q
Sup. ut. 1.1	0.00	0.00	0.00	12.00	11.00	0.00	0.00	0.00
M 1	4.50	1.00	1.00	3.00	6.50	0.00	0.00	0.00
M 2	4.50	3.50	1.00	3.00	6.50	0.00	0.00	0.00

Altro

Nr.	xm[m]	ym[m]	zm[m]	Lungh.	Largh.	Angolo di rotazione			rho[%]
						Asse Z	Asse L	Asse Q	
A 1.2	-0.00	9.00	0.00	12.00	2.00	0.00	0.00	0.00	50
A 1.1	-0.00	0.00	0.00	12.00	2.00	0.00	0.00	0.00	50

6.1 Descrizione, PASSAGGIO PEDONALE 1 - 3

6.1.2 Pianta

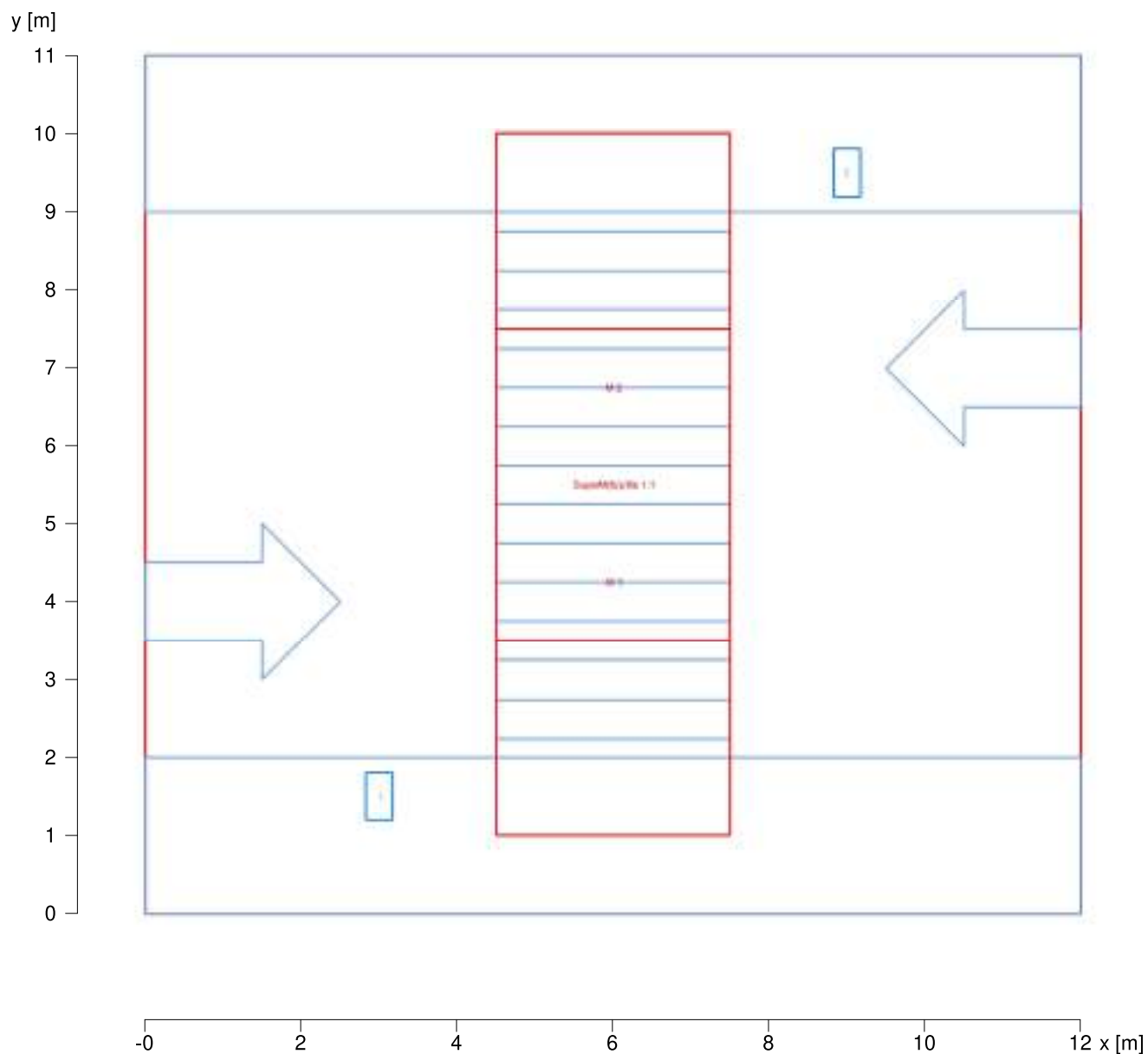

6 PASSAGGIO PEDONALE 1 - 3

6.2 Risultati calcolo, PASSAGGIO PEDONALE 1 - 3

6.2.1 Tabella, Attraversamento pedonale 1 (E verticale)

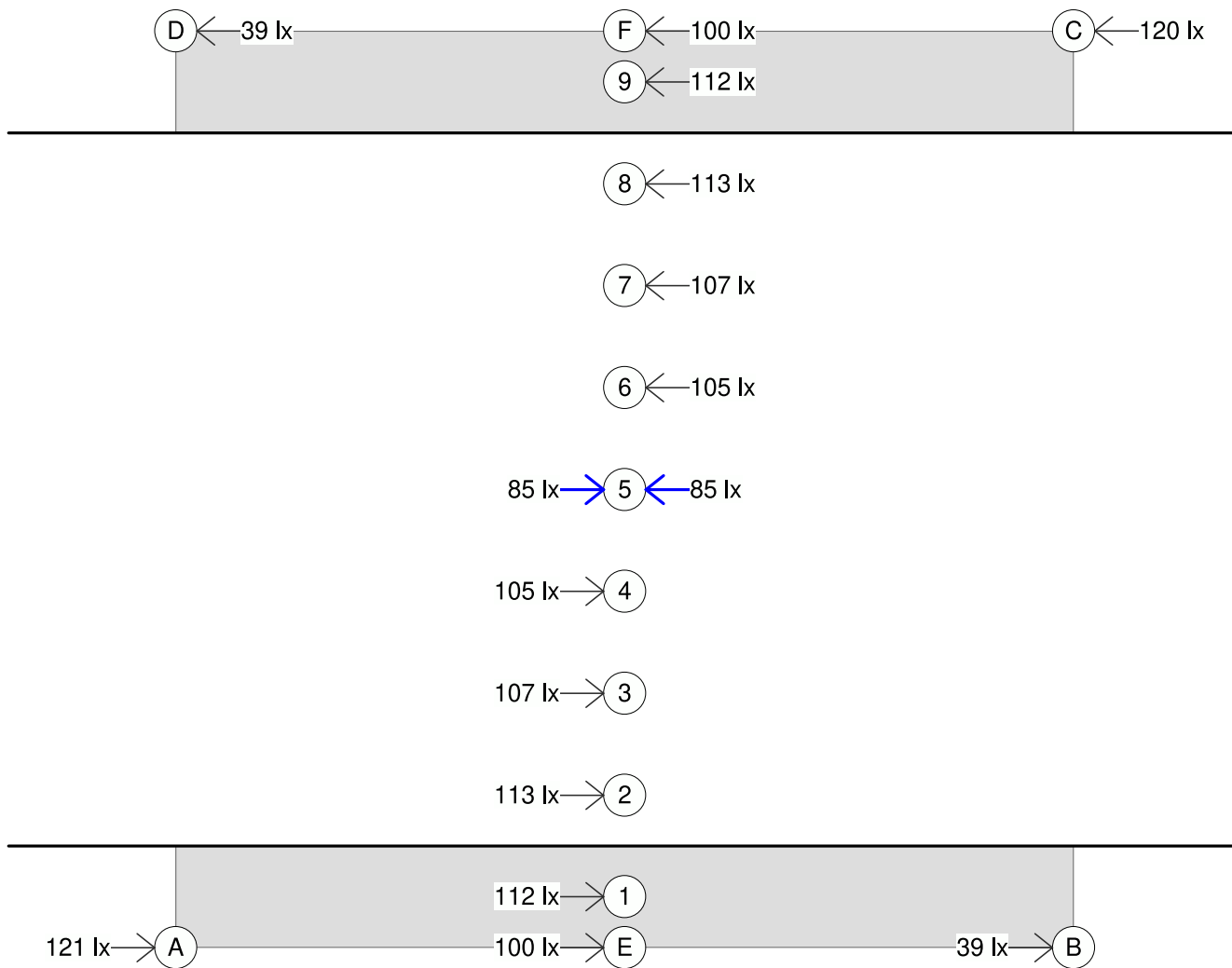

M(fu) 1

DIN 67523-2:2010: Dimensioni:3m x 7m Area di attesa: 1m (6 | 6 centro punti), Altezza di calcolo:2m, Separazione direzioni

	Ev,min	Ev
sinistra ->	85 lx	105 lx
<-destra	85 lx	105 lx
DIN	>= 4.00 lx	

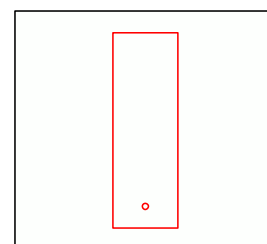

6.2 Risultati calcolo, PASSAGGIO PEDONALE 1 - 3

6.2.2 Tabella, Superficie di misurazione 1 (Ev, 270°)

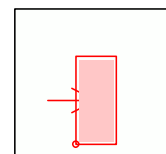
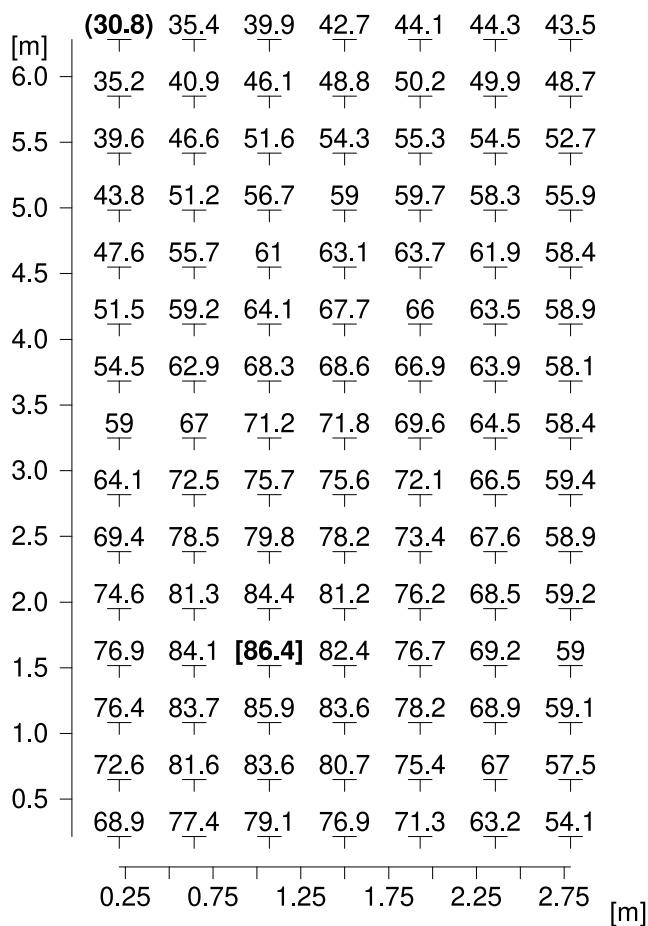

Illuminamento verticale		
Altezza del piano di riferimento		: 1.00 m
dalla direzione di		: 270°
Illuminamento medio	Em	: 63.6 lx
Illuminamento minimo	Emin	: 30.8 lx
Illuminamento massimo	Emax	: 86.4 lx
Uniformità Uo	Emin/Em	: 1 : 2.07 (0.48)
Uniformità Ud	Emin/Emax	: 1 : 2.80 (0.36)

6.2 Risultati calcolo, PASSAGGIO PEDONALE 1 - 3

6.2.3 Tabella, Superficie di misurazione 2 (Ev, 90°)

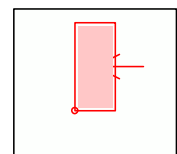
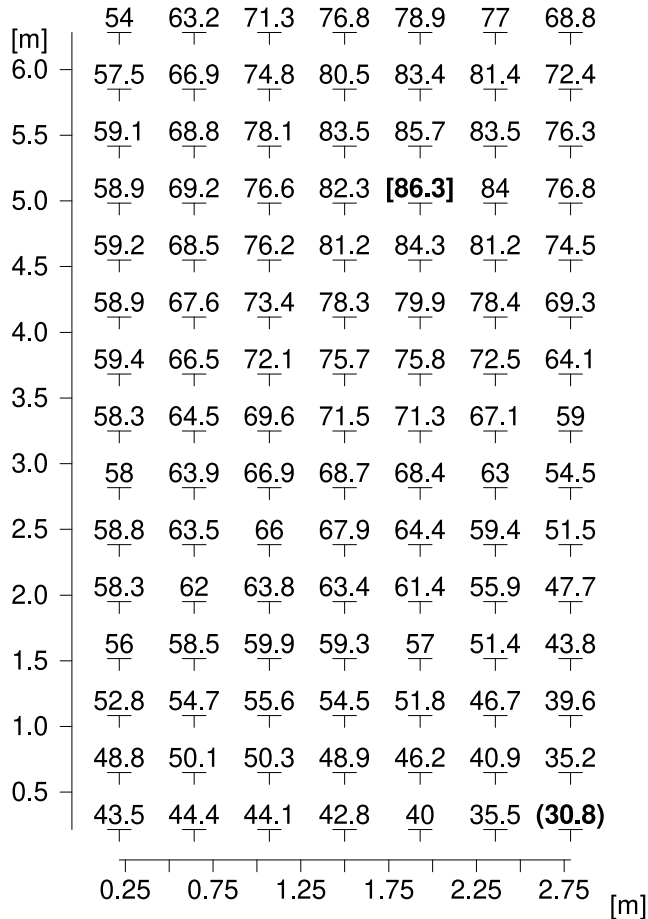

Illuminamento verticale		
Altezza del piano di riferimento		: 1.00 m
dalla direzione di		: 90°
Illuminamento medio	Em	: 63.7 lx
Illuminamento minimo	Emin	: 30.8 lx
Illuminamento massimo	Emax	: 86.3 lx
Uniformità Uo	Emin/Em	: 1 : 2.07 (0.48)
Uniformità Ud	Emin/Emax	: 1 : 2.80 (0.36)

Oggetto : PUBBLICA ILLUMINAZIONE
Impianto : VENEZIA
Numero progetto : 471a -22
Data : 09.11.2022



7 PASSAGGIO PEDONALE 2

7.1 Descrizione, PASSAGGIO PEDONALE 2

7.1.1 Dati punti luce/Elementi dell' interno

Dati prodotti:

Tipo Num. Marca

AEC ILLUMINAZIONE SRL		
7	1 x	Codice : ITALO 1 0F6 OP-SX 3.5-1M
		Nome punto luce : ITALO 1 0F6 OP-SX 3.5-1M
		Sorgenti : 1 x L-IT1-0F6-3000-525-1M-70-25 39 W / 4800 lm
8	1 x	Codice : ITALO 1 0F6 OP-DX 3.5-1M
		Nome punto luce : ITALO 1 0F6 OP-DX 3.5-1M
		Sorgenti : 1 x L-IT1-0F6-3000-525-1M-70-25 39 W / 4800 lm

7 PASSAGGIO PEDONALE 2

7.1 Descrizione, PASSAGGIO PEDONALE 2

7.1.1 Dati punti luce/Elementi dell' interno

Piano con posizione dell'apparecchio e del sensore:



Nr.	Centro			Angolo di rotazione			Coordinate destinazione		
	X [m]	Y [m]	Z [m]	Z [°]	C0 [°]	C90 [°]	Xa [m]	Ya [m]	Za [m]
AEC ILLUMINAZIONE SRL ITALO 1 0F6 OP-SX 3.5-1M ITALO 1 0F6 OP-SX 3.5-1M									
2	3.00	8.20	4.95	180.00	0.00	0.00	5.74	8.20	0.20
AEC ILLUMINAZIONE SRL ITALO 1 0F6 OP-DX 3.5-1M ITALO 1 0F6 OP-DX 3.5-1M									
1	3.00	1.50	4.95	0.00	0.00	0.00	5.74	1.50	0.20

Elementi di creazione

Superficie

Nr.	xm[m]	ym[m]	zm[m]	Lungh.	Largh.	Angolo di rotazione			rho[%]
						Asse Z	Asse L	Asse Q	
Superficie 3									
S 1.3	4.50	7.25	0.00	3.00	0.50	0.00	0.00	0.00	94
Superficie 8									
S 1.8	4.50	6.25	0.00	3.00	0.50	0.00	0.00	0.00	94
Superficie 4									
S 1.4	4.50	5.25	0.00	3.00	0.50	0.00	0.00	0.00	94
Superficie 6									
S 1.6	4.50	4.25	0.00	3.00	0.50	0.00	0.00	0.00	94
Superficie 7									
S 1.7	4.50	3.25	0.00	3.00	0.50	0.00	0.00	0.00	94

Oggetto : PUBBLICA ILLUMINAZIONE
 Impianto : VENEZIA
 Numero progetto : 471a -22
 Data : 09.11.2022

7 PASSAGGIO PEDONALE 2

7.1 Descrizione, PASSAGGIO PEDONALE 2

7.1.1 Dati punti luce/Elementi dell' interno

S 1.1	4.50	2.25	0.00	3.00	0.50	0.00	0.00	0.00	94
S 1.9	-0.00	4.50	0.00	2.50	2.00	0.00	0.00	0.00	94

Superficie di misurazione

Nr.	xm[m]	ym[m]	zm[m]	Lungh.	Largh.	Angolo di rotazione		
						Asse Z	Asse L	Asse Q
Sup. ut. 1.1	0.00	0.00	0.00	12.00	9.70	0.00	0.00	0.00

Altro

Nr.	xm[m]	ym[m]	zm[m]	Lungh.	Largh.	Angolo di rotazione			rho[%]
						Asse Z	Asse L	Asse Q	
A 1.2	-0.00	7.70	0.00	12.00	2.00	0.00	0.00	0.00	50
A 1.1	-0.00	0.00	0.00	12.00	2.00	0.00	0.00	0.00	50

7.1 Descrizione, PASSAGGIO PEDONALE 2

7.1.2 Pianta

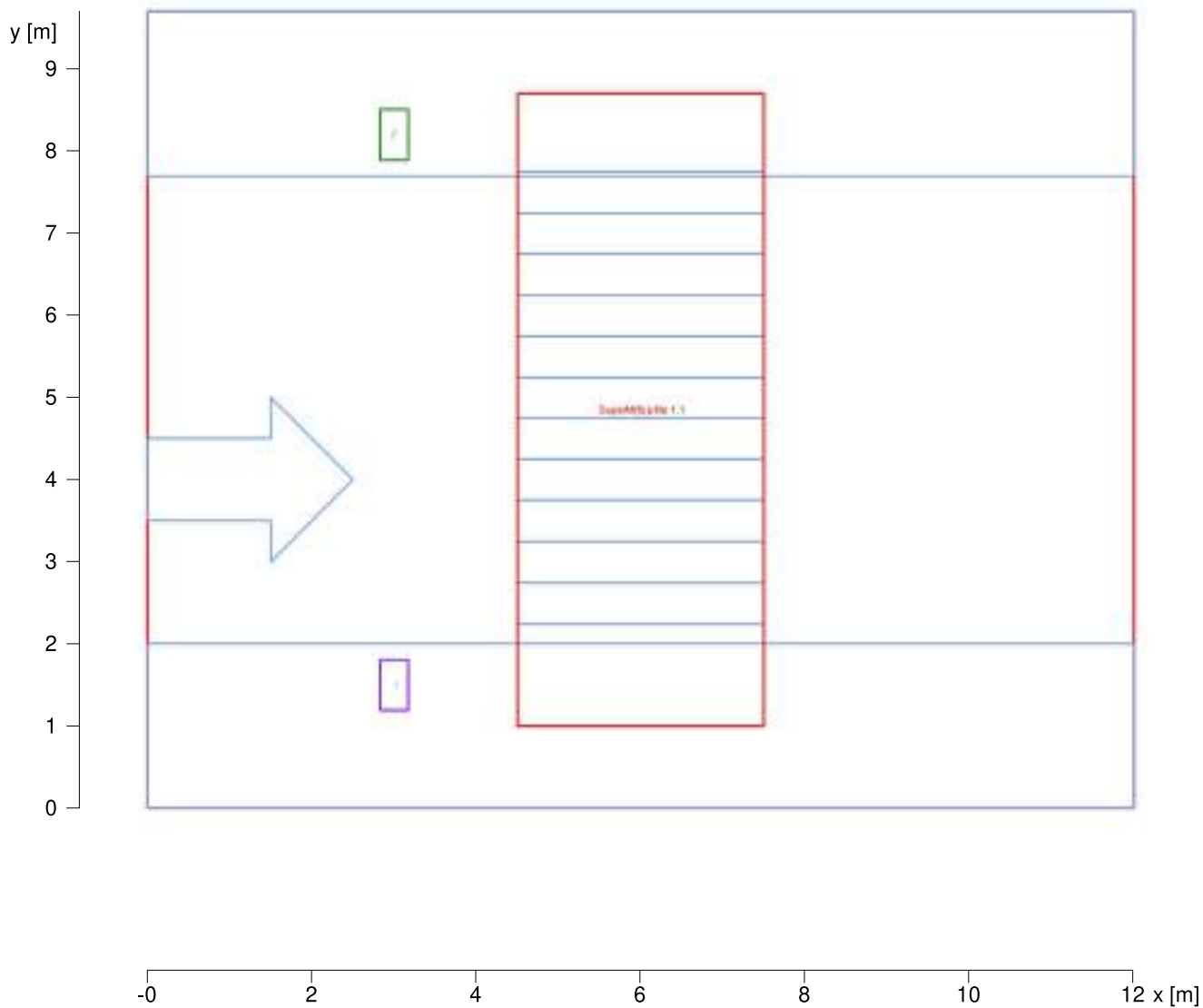

7 PASSAGGIO PEDONALE 2

7.2 Riepilogo, PASSAGGIO PEDONALE 2

7.2.1 Panoramica risultato, Area di valutazione 1

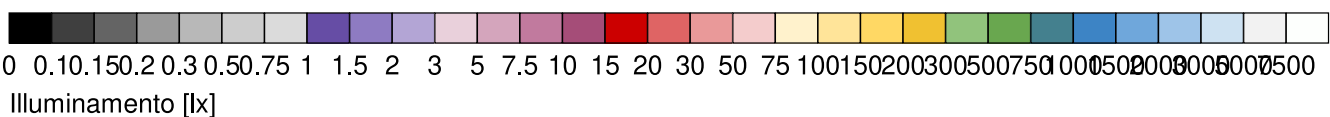
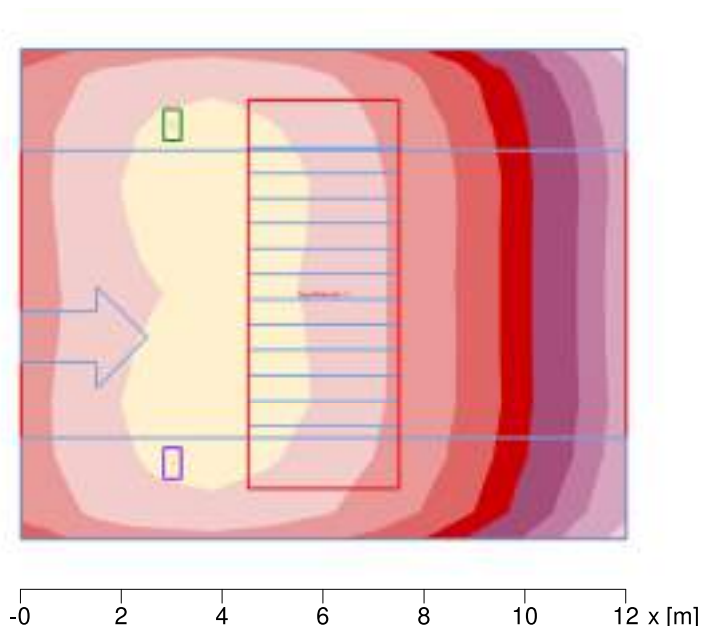

Generale

Algoritmo di calcolo utilizzato:	Percentuale indiretta media
Altezza (centro fotom.):	4.95 m
Fattore di manut.	0.80
Flusso Totale	9600.00 lm
Potenza totale	78.0 W
Potenza totale per superficie (116.40 m ²)	0.67 W/m ² (1.37 W/m ² /100lx)

Area di valutazione 1

Superficie utile 1.1

Em	Orizzontale
Emin	48.9 lx
Emin/Em (Uo)	6.6 lx
Emin/Emax (Ud)	0.14
Posizione	0.07
	0.00 m

Tipo Num. Marca

AEC ILLUMINAZIONE SRL	
7 1 x	Codice : ITALO 1 0F6 OP-SX 3.5-1M
	Nome punto luce : ITALO 1 0F6 OP-SX 3.5-1M
	Sorgenti : 1 x L-IT1-0F6-3000-525-1M-70-25 39 W / 4800 lm
8 1 x	Codice : ITALO 1 0F6 OP-DX 3.5-1M
	Nome punto luce : ITALO 1 0F6 OP-DX 3.5-1M
	Sorgenti : 1 x L-IT1-0F6-3000-525-1M-70-25 39 W / 4800 lm

Oggetto : PUBBLICA ILLUMINAZIONE
Impianto : VENEZIA
Numero progetto : 471a -22
Data : 09.11.2022

7.2 Riepilogo, PASSAGGIO PEDONALE 2

7.2.2 Sommario Esterni, PASSAGGIO PEDONALE 2

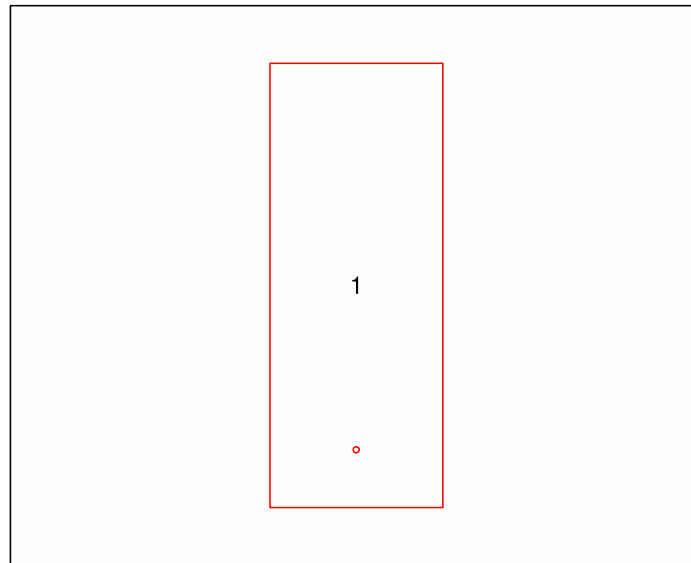

Generale

Algoritmo di calcolo utilizzato: Percentuale indiretta media
Fattore di manut. 0.80

Superfici di misura

Attraversamento pedonale

M(fu) 1

DIN 67523-2:2010: Dimensioni:3m x 5.7m Area di attesa: 1m, Altezza di calcolo:2m, Da sinistra

	Ev,min	\bar{E}_v
sinistra ->	59 lx	84 lx
DIN	>= 4.00 lx	

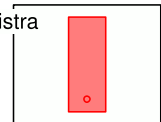

Oggetto : PUBBLICA ILLUMINAZIONE
Impianto : VENEZIA
Numero progetto : 471a -22
Data : 09.11.2022

7 PASSAGGIO PEDONALE 2

7.3 Risultati calcolo, PASSAGGIO PEDONALE 2

7.3.1 Tabella, Attraversamento pedonale 1 (E verticale)

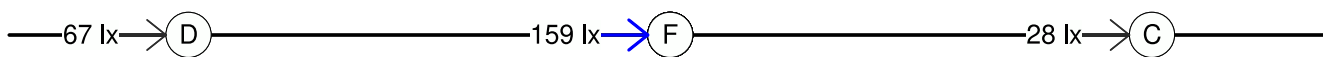

M(fu) 1

DIN 67523-2:2010: Dimensioni:3m x 5.7m Area di attesa: 1m, Altezza di calcolo:2m, Da sinistra

	Ev,min	Ev
sinistra ->	59 lx	84 lx
DIN	≥ 4.00 lx	

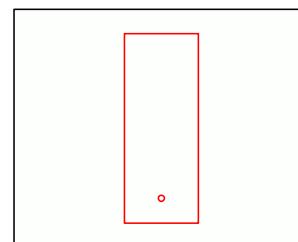

Oggetto : PUBBLICA ILLUMINAZIONE
Impianto : VENEZIA
Numero progetto : 471a -22
Data : 09.11.2022

8 CAMPETTO

8.1 Descrizione, CAMPETTO

8.1.1 Dati punti luce/Elementi dell' interno

Dati prodotti:

Tipo Num. Marca

		AEC ILLUMINAZIONE SRL	
11	12 x	Codice	: Galileo 1 0F6 ASC-6W 3.7-3M
		Nome punto luce	: Galileo 1 0F6 ASC-6W 3.7-3M
		Sorgenti	: 1 x L-GAL1-0F6-3000-700-3M-70-25 150 W / 16670 lm

8 CAMPETTO

8.1 Descrizione, CAMPETTO

8.1.1 Dati punti luce/Elementi dell' interno

Piano con posizione dell'apparecchio e del sensore:

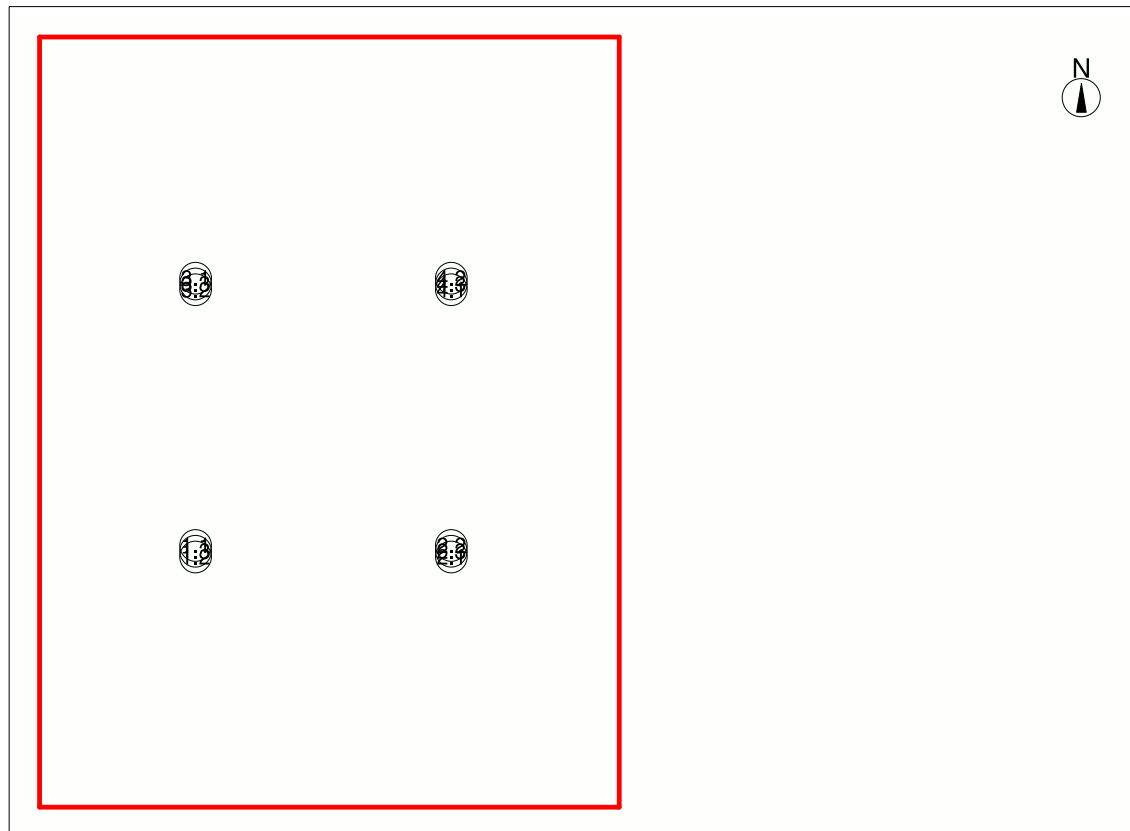

Nr.	Centro			Angolo di rotazione			Coordinate destinazione		
	X [m]	Y [m]	Z [m]	Z [°]	C0 [°]	C90 [°]	Xa [m]	Ya [m]	Za [m]
AEC ILLUMINAZIONE SRL Galileo 1 0F6 ASC-6W 3.7-3M Galileo 1 0F6 ASC-6W									
3.7-3M									
1.1	-2.00	8.00	10.90	315.00	0.00	0.00	-2.00	8.00	0.00
1.2	-2.00	7.00	10.90	225.00	0.00	0.00	-2.00	7.00	0.00
1.3	-2.00	7.50	10.90	270.00	0.00	0.00	-2.00	7.50	0.00
3.1	-2.00	31.00	10.90	315.00	0.00	0.00	-2.00	31.00	0.00
3.2	-2.00	30.00	10.90	225.00	0.00	0.00	-2.00	30.00	0.00
3.3	-2.00	30.50	10.90	270.00	0.00	0.00	-2.00	30.50	0.00
2.1	20.00	7.00	10.90	135.00	0.00	0.00	20.00	7.00	0.00
2.2	20.00	8.00	10.90	45.00	0.00	0.00	20.00	8.00	0.00
2.3	20.00	7.50	10.90	90.00	0.00	0.00	20.00	7.50	0.00
4.1	20.00	30.00	10.90	135.00	0.00	0.00	20.00	30.00	0.00
4.3	20.00	30.50	10.90	90.00	0.00	0.00	20.00	30.50	0.00
4.2	20.00	31.00	10.90	45.00	0.00	0.00	20.00	31.00	0.00

Elementi di creazione

Superficie di misurazione

Nr.	xm[m]	ym[m]	zm[m]	Lungh.	Largh.	Angolo di rotazione		
						Asse Z	Asse L	Asse Q
Impianto sportivo 1.1	0.00	0.00	0.00	18.00	38.00	0.00	0.00	0.00

Oggetto : PUBBLICA ILLUMINAZIONE
Impianto : VENEZIA
Numero progetto : 471a -22
Data : 09.11.2022

8 CAMPETTO

8.1 Descrizione, CAMPETTO

8.1.1 Dati punti luce/Elementi dell' interno

8.1 Descrizione, CAMPETTO

8.1.2 Pianta

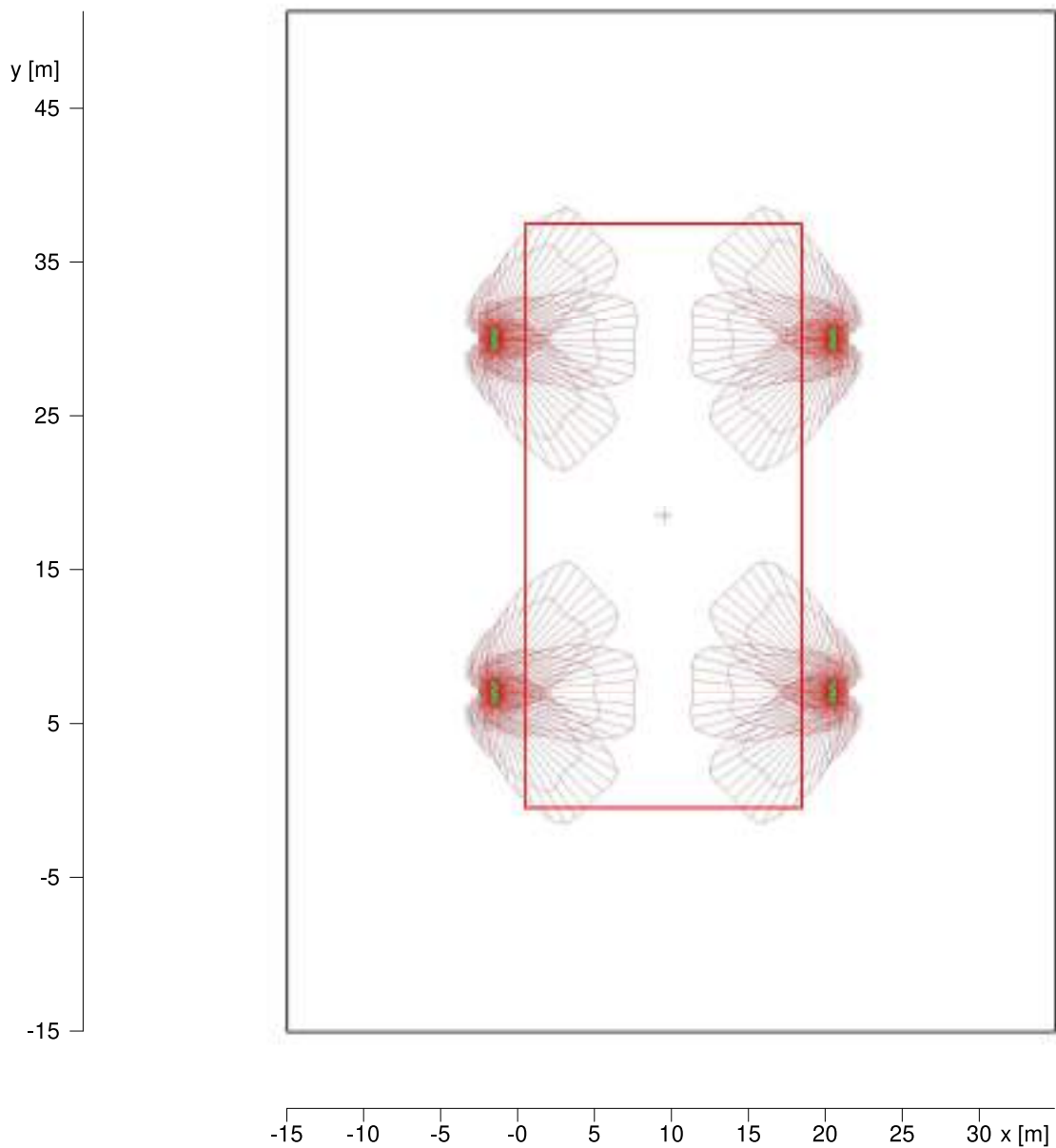

Oggetto : PUBBLICA ILLUMINAZIONE
 Impianto : VENEZIA
 Numero progetto : 471a -22
 Data : 09.11.2022

8 CAMPETTO

8.2 Riepilogo, CAMPETTO

8.2.1 Panoramica risultato, Impianto sportivo 1.1

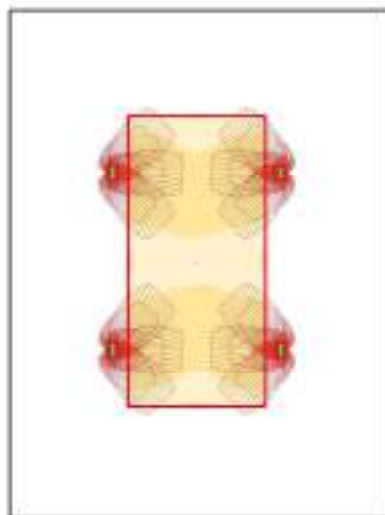

-15 -5 -0 5 10 15 20 25 30 x [m]

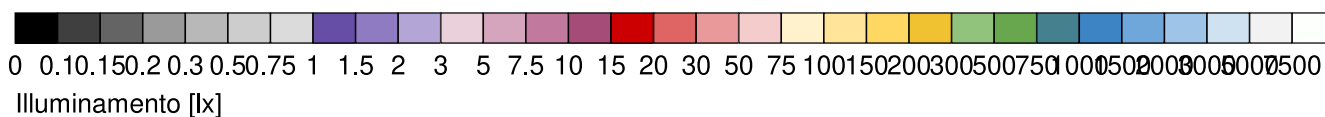

Generale

Algoritmo di calcolo utilizzato:	Percentuale indiretta media
Altezza area di valutazione	0.00 m
Altezza (centro fotom.) [m]:	10.90 m
Fattore di manut.	0.80
Flusso Totale	200040 lm
Potenza totale	1800 W
Potenza totale per superficie (3308.09 m ²)	0.54 W/m ² (0.51 W/m ² /100lx)

Illuminamento

Illuminamento medio	Em	107 lx
Illuminamento minimo	Emin	76 lx
Illuminamento massimo	Emax	150 lx
Uniformità Uo	Emin/Em	1:1.41 (0.71)
Uniformità Ud	Emin/Emax	1:1.98 (0.51)

Tipo Num. Marca

11 12 x

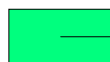

AEC ILLUMINAZIONE SRL

Codice : Galileo 1 0F6 ASC-6W 3.7-3M
 Nome punto luce : Galileo 1 0F6 ASC-6W 3.7-3M
 Sorgenti : 1 x L-GAL1-0F6-3000-700-3M-70-25 150 W / 16670 lm

8 CAMPETTO

8.3 Risultati calcolo, CAMPETTO

8.3.1 Tabella, Impianto sportivo 1.1 (E)

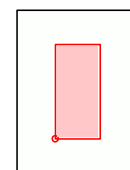
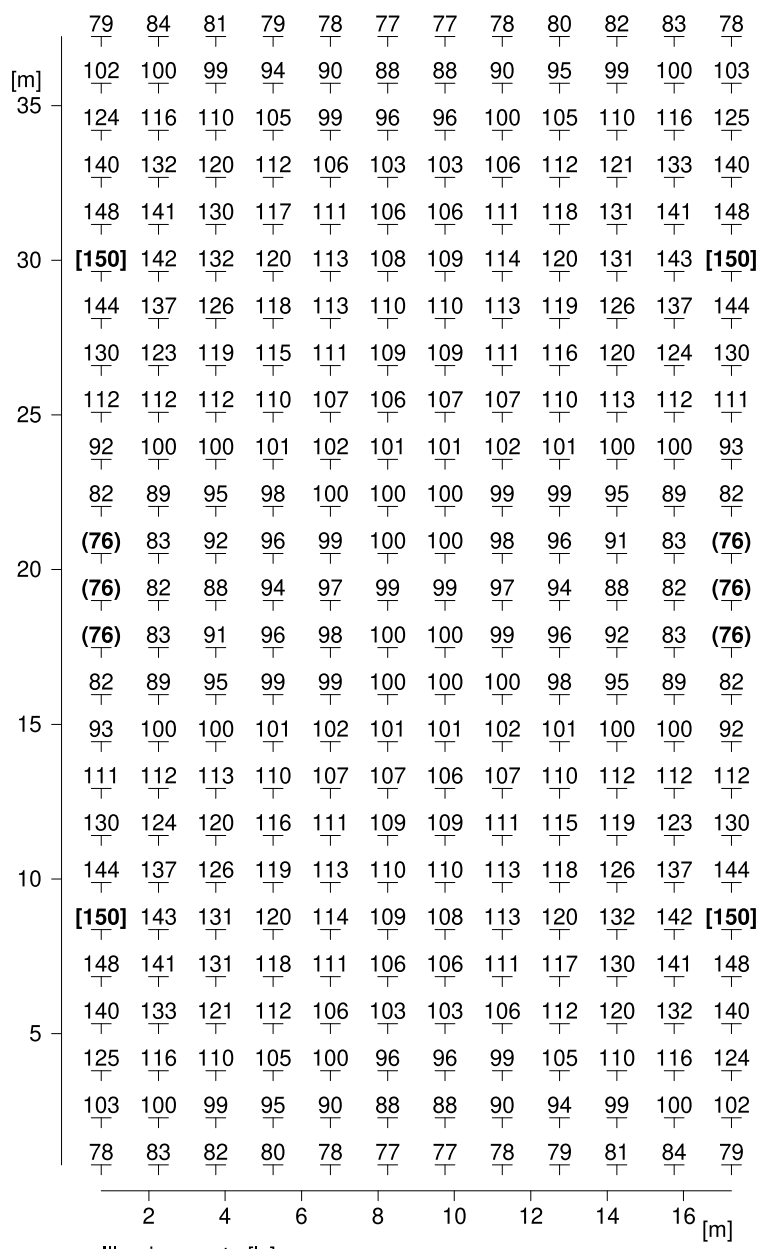

Altezza del piano di riferimento	:	0.00 m
Illuminamento medio	Em	: 107 lx
Illuminamento minimo	Emin	: 76 lx
Illuminamento massimo	Emax	: 150 lx
Uniformità Uo	Emin/Em	: 1 : 1.41 (0.71)
Uniformità Ud	Emin/Emax	: 1 : 1.98 (0.51)

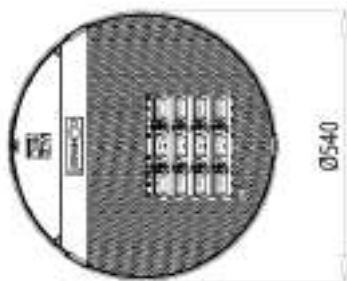

COMPASS 1 TP-BR/TP/AM

CARATTERISTICHE PRINCIPALI

Applicazioni	Illuminazione stradale e urbana.
Gruppo ottico	<p>STU-S: Ottica asimmetrica per illuminazione stradale, urbana e ciclopedonale (emissione stretta).</p> <p>STU-M: Ottica asimmetrica per illuminazione stradale, urbana e ciclopedonale (emissione media).</p> <p>STU-W: Ottica asimmetrica per illuminazione di strade larghe urbane e extraurbane.</p> <p>S03: Ottica asimmetrica per illuminazione di strade larghe urbane e extraurbane.</p> <p>S: Ottica simmetrica per illuminazione urbana e aree verdi.</p> <p>Temperatura di colore: 4000K (3000K in opzione) CRI ≥ 70</p> <p>LOR= 100%, DLOR= 100%, ULOR= 0%</p> <p>Classe di sicurezza fotobiologica: EXEMPT GROUP</p> <p>Efficienza sorgente LED: 174 lm/W @ 400mA, T_j=85°C, 4000K</p>
Classe di isolamento	II, I
Grado di protezione	IP66 IK08 totale
Moduli LED	Rimovibili
Dimensioni	Vedere disegno
Peso	max 10.5 kg
Superficie esposta	Laterale: 0.05m ² – Pianta: 0.25m ²
Montaggio	<p>TP-BR: Testa Palo: Ø48-60mm – Braccio: Ø42-60mm.</p> <p>Inclinazione: Testa palo: 0°, +5°, +10°, +15°, +20° Braccio: +5°, 0°, -5°, -10°, -15°, -20°.</p> <p>TP: installazione a cima palo Ø60-76-102mm Inclinazione: 0°, +5°, +10°, +15°, +20°.</p> <p>AM: installazione a muro. Inclinazione: 0°, +5°, +10°, +15°, +20°.</p>
Cablaggio	Piastra cablaggio rimovibile in campo.
Temp. di esercizio	-40°C / +50°C
Temp. di stoccaggio	-40°C / +80°C
Norme di riferimento	EN 60598-1, EN 60598-2-3, EN 62471, EN 55015, EN 61547, EN 61000-3-2, EN 61000-3-3



CARATTERISTICHE ELETTRICHE

Alimentazione	220÷240V 50/60Hz
Fattore di potenza	>0,9 (a pieno carico, F, DA, DAC)
Sezionatore	Incluso, con ferma cavo integrato.
Connessione rete	Per cavi sezione max. 4mm ²
Protez. sovratensioni	Fino a 10kV Con SPD (in opzione) 10kV / 10kV CM/DM
SPD (in opzione)	10kV-10kA, type 2+3, completo di LED di segnalazione e termofusibile per disconnessione del carico a fine vita.
Sistema di controllo (opzioni)	<p>F: Fisso non dimmerabile.</p> <p>DA: Dimmerazione automatica (mezzanotte virtuale) con profilo di default.</p> <p>DAC: Profilo DA custom.</p> <p>FLC: Flusso luminoso costante.</p> <p>WL: Telecontrollo punto/punto ad onde radio.</p> <p>DALI: Interfaccia di dimmerazione digitale DALI.</p> <p>NEMA: Presa 7 pin (ANSI C136.41).</p> <p>ZHAGA: Presa 4 pin (ZHAGA Book 18).</p>
Vita gruppo ottico (T_q=25°C, 500mA)	<p>>100.000hr L90B10</p> <p>>100.000hr L90, TM21</p>

MATERIALI

Attacco	
Corpo	Alluminio pressofuso UNI EN1706. Verniciato a polveri.
Gancio di chiusura	
Gruppo ottico	Alluminio 99.85% con finitura superficiale realizzata con deposizione sotto vuoto 99.95%. (Alluminio classe A+ DIN EN 16268)
Schermo	Vetro piano temperato sp. 5mm elevata trasparenza.
Pressacavo	Plastico M20x1.5 - IP68
Guarnizione	Poliuretanicca
Colore	Grafite - Cod. 01

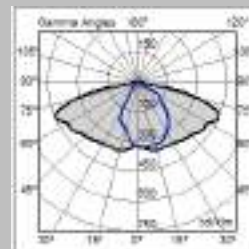

Optica STU-S

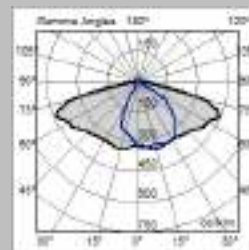

Optica STU-M

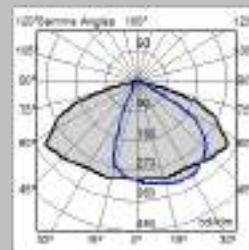

Optica STU-W

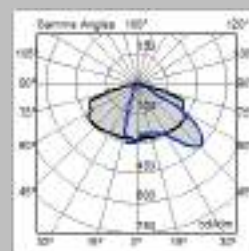

Optica S03

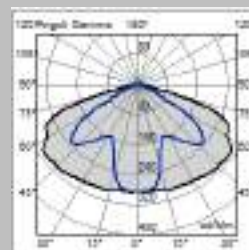

Optica S

Tutti i dati fotometrici pubblicati sono stati rilevati in conformità alle normative internazionali vigenti



TP-BR

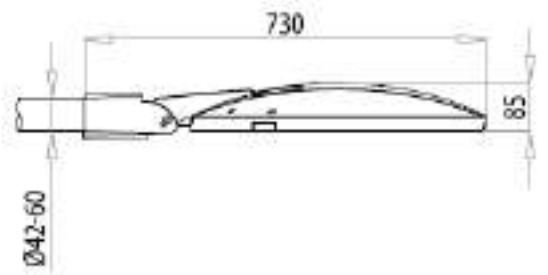
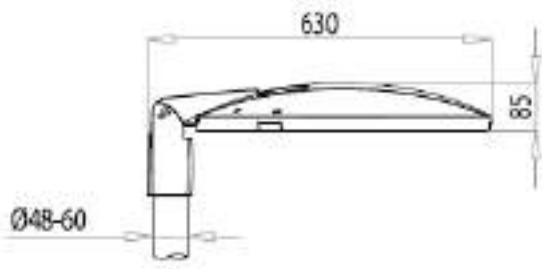

TP

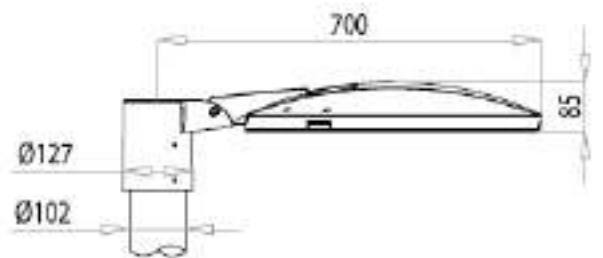
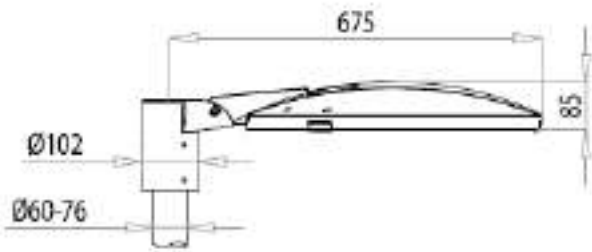

AM

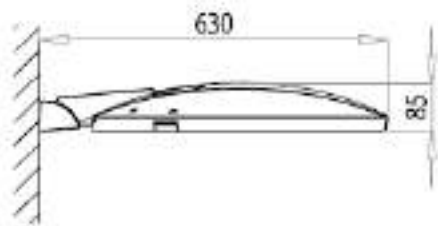



APPARECCHIO	OTTICA	CORRENTE LED (mA)	FLUSSO APPARECCHIO* (Tq=25°C, 4000K, lm)	POTENZA APPARECCHIO* (Tq=25°C, Vin=230Vac, F/DA/DAC, W)	EFFICIENZA APPARECCHIO (Tq=25°C, lm/W)	FLUSSO NOMINALE LED* (Tj=85°C, 4000K, lm)	POTENZA NOMINALE LED* (Tj=85°C, W)
COMPASS 1 2Z8 4.40-1M	STU-M STU-S STU-W	400	2830	21.5	131	3175	18
COMPASS 1 2Z8 4.40-2M			5700	40.5	140	6351	36
COMPASS 1 2Z8 4.40-3M			8490	59.5	142	9526	54
COMPASS 1 2Z8 4.40-4M			11180	79.5	140	12701	72
COMPASS 1 2Z8 4.50-1M	STU-M STU-S STU-W	500	3420	27	126	3896	23
COMPASS 1 2Z8 4.50-2M			6950	51.5	134	7792	46
COMPASS 1 2Z8 4.50-3M			10250	75.5	135	11688	68
COMPASS 1 2Z8 4.50-4M			13370	100	133	15585	91
COMPASS 1 2Z8 4.40-1M	S03	400	2780	21.5	129	3175	18
COMPASS 1 2Z8 4.40-2M			5590	40.5	138	6351	36
COMPASS 1 2Z8 4.40-3M			8320	59.5	139	9526	54
COMPASS 1 2Z8 4.40-4M			10950	79.5	137	12701	72
COMPASS 1 2Z8 4.50-1M	S03	500	3350	27	124	3896	23
COMPASS 1 2Z8 4.50-2M			6820	51.5	132	7792	46
COMPASS 1 2Z8 4.50-3M			10050	75.5	133	11688	68
COMPASS 1 2Z8 4.50-4M			13100	100	131	15585	91
COMPASS 1 2Z8 4.40-2M	S	400	5590	40.5	138	6351	36
COMPASS 1 2Z8 4.40-4M			10950	79.5	137	12701	72
COMPASS 1 2Z8 4.50-2M	S	500	6820	51.5	132	7792	46
COMPASS 1 2Z8 4.50-4M			13100	100	131	15585	91

*FLUSSO APPARECCHIO / POTENZA APPARECCHIO: Dati nominali rilevati in laboratorio.

*FLUSSO NOMINALE LED / POTENZA NOMINALE LED: Dati nominali estrapolati da datasheet costruttore LED.

I valori indicati in questa scheda tecnica sono da considerarsi valori nominali. Tolleranza su flusso: +/-7%. Tolleranza su potenza: +/-5%.

Tolleranza su potenza in versioni ZHAGA o con alimentatore D4/SR: +/-10%.

Al fine di favorire un costante aggiornamento dei propri prodotti, AEC si riserva il diritto di apportare modifiche senza preavviso.



APPARECCHIO	OTTICA	CORRENTE LED (mA)	FLUSSO APPARECCHIO* (Tq=25°C, 3000K, lm)	POTENZA APPARECCHIO* (Tq=25°C, Vin=230Vac, F/DA/DAC, W)	EFFICIENZA APPARECCHIO (Tq=25°C, lm/W)	FLUSSO NOMINALE LED* (Tj=85°C, 3000K, lm)	POTENZA NOMINALE LED* (Tj=85°C, W)
COMPASS 1 2Z8 3.40-1M	STU-M STU-S STU-W	400	2780	21.5	129	3112	18
COMPASS 1 2Z8 3.40-2M			5590	40.5	138	6224	36
COMPASS 1 2Z8 3.40-3M			8320	59.5	139	9336	54
COMPASS 1 2Z8 3.40-4M			10950	79.5	137	12447	72
COMPASS 1 2Z8 3.50-1M	STU-M STU-S STU-W	500	3350	27	124	3818	23
COMPASS 1 2Z8 3.50-2M			6820	51.5	132	7636	46
COMPASS 1 2Z8 3.50-3M			10050	75.5	133	11455	68
COMPASS 1 2Z8 3.50-4M			13100	100	131	15273	91
COMPASS 1 2Z8 3.40-1M	S03	400	2720	21.5	126	3112	18
COMPASS 1 2Z8 3.40-2M			5480	40.5	135	6224	36
COMPASS 1 2Z8 3.40-3M			8150	59.5	136	9336	54
COMPASS 1 2Z8 3.40-4M			10730	79.5	134	12447	72
COMPASS 1 2Z8 3.50-1M	S03	500	3280	27	121	3818	23
COMPASS 1 2Z8 3.50-2M			6680	51.5	129	7636	46
COMPASS 1 2Z8 3.50-3M			9840	75.5	130	11455	68
COMPASS 1 2Z8 3.50-4M			12840	100	128	15273	91
COMPASS 1 2Z8 3.40-2M	S	400	5480	40.5	135	6224	36
COMPASS 1 2Z8 3.40-4M			10730	79.5	134	12447	72
COMPASS 1 2Z8 3.50-2M	S	500	6680	51.5	129	7636	46
COMPASS 1 2Z8 3.50-4M			12840	100	128	15273	91

*FLUSSO APPARECCHIO / POTENZA APPARECCHIO: Dati nominali rilevati in laboratorio.

*FLUSSO NOMINALE LED / POTENZA NOMINALE LED: Dati nominali estrapolati da datasheet costruttore LED.

I valori indicati in questa scheda tecnica sono da considerarsi valori nominali. Tolleranza su flusso: +/-7%. Tolleranza su potenza: +/-5%.

Tolleranza su potenza in versioni ZHAGA o con alimentatore D4/SR: +/-10%.

Al fine di favorire un costante aggiornamento dei propri prodotti, AEC si riserva il diritto di apportare modifiche senza preavviso.



DICHIARAZIONE DI CONFORMITÀ



AEC ILLUMINAZIONE S.r.l.



Il seguente costruttore

Costruttore: **AEC ILLUMINAZIONE S.r.l.**

Indirizzo: Via A. Righi, 4 - Zona industriale Castelnuovo
52010 Subbiano (AR) - Italia

dichiara qui di seguito che il prodotto

COMPASS 1 2Z8 STU-W 3.50-2M

apparecchio di illuminazione per l'installazione fissa

presenta caratteristiche fotometriche conformi a quanto previsto dalla seguente legge

Regione Veneto - Legge Regionale n° 17 del 7 agosto 2009

Subbiano, 16/11/2020

AEC ILLUMINAZIONE S.r.l.



DICHIARAZIONE DI CONFORMITÀ



AEC ILLUMINAZIONE S.r.l.

MADE IN ITALY

Il seguente costruttore

Costruttore: **AEC ILLUMINAZIONE S.r.l.**

Indirizzo: Via A. Righi, 4 - Zona industriale Castelnuovo
52010 Subbiano (AR) - Italia

dichiara qui di seguito che il prodotto

COMPASS 1 2Z8 STU-M 3.40-2M

apparecchio di illuminazione per l'installazione fissa

presenta caratteristiche fotometriche conformi a quanto previsto dalla seguente legge

Regione Veneto - Legge Regionale n° 17 del 7 agosto 2009

Subbiano, 16/11/2020

AEC ILLUMINAZIONE S.r.l.



DICHIARAZIONE DI CONFORMITÀ



AEC ILLUMINAZIONE S.r.l.



Il seguente costruttore

Costruttore: **AEC ILLUMINAZIONE S.r.l.**

Indirizzo: Via A. Righi, 4 - Zona industriale Castelnuovo
52010 Subbiano (AR) - Italia

dichiara qui di seguito che il prodotto

COMPASS 1 2Z8 S03 3.40-3M

apparecchio di illuminazione per l'installazione fissa

presenta caratteristiche fotometriche conformi a quanto previsto dalla seguente legge

Regione Veneto - Legge Regionale n° 17 del 7 agosto 2009

Subbiano, 16/11/2020

AEC ILLUMINAZIONE S.r.l.

Photometric Test Report



Costruttore	AEC ILLUMINAZIONE SRL
Tipo di prodotto	Outdoor Lighting Luminaire
Codice fotometria	COMPASS 1 2Z8 S03 3.40-3M
Codice apparecchio	COMPASS 1 2Z8 S03 3.40-3M
Rilievo fotometrico	20-187_0920
Descrizione apparecchio	COMPASS 1 2Z8 S03 3.40-3M
Data emissione	06-11-2020

Foto del prodotto



Responsabile laboratorio fotometrico	Luca Vagheggi	
Tecnico laboratorio che ha eseguito la misura	Alessio Vagheggi	



Sommario e Allegati

Sommario	Dati apparecchio	
	Normative di riferimento	
	Procedure di riferimento	
	Condizioni di prova	
	Risultati fotometrici	
	Lista strumentazione	
	Incertezza strumentale	
Allegati	Dati Generali	X
	Tabella fotometrica delle Intensità (cd/Klm)	X
	Tabella fotometrica delle Intensità (cd)	
	Diagramma Polare	
	Diagramma Cartesiano	
	Valutazione UGR	
	Diagramma Sollner Abbagliamento	
	Flusso Zonale	
	Coefficienti di Utilizzazione	
	Isolux Unitario	
	Isocandele Percentuale	
	Tabella e Diagramma Luminanza	
	Classificazione Strade	X
Classificazione Strade IES TM-15		

DATI APPARECCHIO

Geometria apparecchio	Circolare		
Dimensioni apparecchio (mm)	Lunghezza / Diametro	Larghezza	Altezza
	540	540	85
Dimensioni area luminosa (mm)	Lunghezza / Diametro	Larghezza	Altezza C0
	135	225	0
	Altezza C90	Altezza C180	Altezza C270
	0	0	0
Tipo sorgente	LED		
Modello sorgente	Luxeon 5050s		
Tipo Alimentatore	Elettronico / Electronic		
Modello Alimentatore	Philips Xi		

NORMATIVE DI RIFERIMENTO

Normative di riferimento	UNI EN 13032-1:2012 UNI EN 13032-4:2015
Valutazione luce parassita	In accordo con Annex A UNI EN 13032-1

PROCEDURE DI RIFERIMENTO

Procedure di riferimento	I-QL-009
---------------------------------	----------

CONDIZIONI DI PROVA

Laboratorio fotometrico	Interno AEC ILLUMINAZIONE srl, in regime di sistema di qualità aziendale certificato ISO 9001:2008, autorizzato UL	
Condizioni Ambientali	Temperatura ambiente (°C)	25
	Umidità relativa (°RH)	< 60
	Movimento aria (m/s)	< 0.2
Condizioni Elettriche	Tensione di alimentazione (V)	230
	Frequenza di alimentazione (Hz)	50
	Distorsione armonica THD V (%)	< 0.5%
Condizioni Preliminari Prova	Metodo di misura	Goniofotometro
	Sistema di riferimento misura	Sistema C-γ (Gonio)
	Posizione di misura	Verticale (Gonio)
	Distanza di misura (m)	9.03
	Tempo di stabilizzazione (min)	> 60
	Instabilità sorgente (%)	< 0.5%

I risultati delle verifiche e prove qui riportati, si riferiscono esclusivamente agli esemplari esaminati e descritti nella presente Relazione. L'estensione del riferimento ad esemplari che non siano quelli sottoposti alle verifiche descritte in seguito esula dallo scopo delle verifiche stesse. E' vietata la riproduzione integrale o parziale senza l'autorizzazione scritta di Aec illuminazione srl. L'immagine dell'apparecchio nella prima pagina è puramente indicativa della tipologia di apparecchio sottoposto a test.

RISULTATI FOTOMETRICI

Tipo di misura fotometrica	Assoluta
LOR (%)	100.0
Flusso luminoso apparecchio (lm)	8150
Potenza ingresso apparecchio (W)	59.5
Efficienza apparecchio (lm/W)	137
Note e commenti	

LISTA STRUMENTAZIONE

CODICE AEC	STRUMENTO	COSTRUTTORE	MODELLO
Q129	Luxmetro	Czibula&Grundmann	100310
Q130	Goniofotometro	Oxytech	T2
Q131	Termoigrometro	Delta Ohm	HD2001
Q132	Wattmetro	N4L	PPA2510
Q135	Stabilizzatore	Elettrotest	TPS/M/9KW
Q205	Luxmetro	Czibula&Grundmann	161206

INCERTEZZA STRUMENTALE

Encoder goniofotometro Oxytech T2	Precisione angolare in C – gamma	$\pm 0.044^\circ$
Luxmetro C&G	f1'	< 1.23%
Wattmetro Kinetiq N4L PPA2510	Accuratezza di potenza	< [0.05% + 0.03%/pf + (0.01%/kHz)/pf] Rdg + 0.05%VA Rng

Apparecchio	Rilievo	Lampada
Codice COMPASS 1 2Z8 S03 3.40-3M	Codice 20-187_0920	Codice L-COM-2Z8-3000-400-3M-70-25
Nome COMPASS 1 2Z8 S03 3.40-3M	Nome COMPASS 1 2Z8 S03 3.40-3M	Numero 1
Archivio Eulumdat	Data 06-11-2020	Posizione

Flusso Apparecchio	8150.00 lm	Potenza Apparecchio	59.50 W	Efficacia	136.97 lm/W	Rendimento	100.00%
Flusso Lampade	8150.00 lm	Valore Massimo	534.82 cd/klm	Posizione	C=35.00 G=60.00	CG	Asimmetrico

Tabella Intensità Luminose - cd/klm Tabella 6/18

	C 325.00	C 330.00	C 335.00	C 340.00	C 345.00	C 350.00	C 355.00
G 0.0	283.31	283.31	283.31	283.31	283.31	283.31	283.31
G 1.0	285.36	284.71	284.82	284.36	284.06	284.06	283.56
G 2.0	287.25	287.00	286.47	285.76	284.75	284.70	283.35
G 3.0	288.60	287.70	287.33	285.36	284.60	284.05	282.55
G 4.0	289.24	288.20	287.78	285.06	283.85	283.50	281.59
G 5.0	289.59	288.54	288.08	284.91	283.00	282.80	280.44
G 6.0	289.79	288.84	288.08	284.56	282.35	282.05	279.09
G 7.0	289.89	288.89	288.23	284.31	282.20	281.55	278.14
G 8.0	289.99	289.19	288.58	284.51	282.20	281.55	277.58
G 9.0	290.19	289.80	289.34	285.46	282.80	282.35	277.74
G 10.0	290.59	290.85	290.74	286.91	283.90	283.60	278.64
G 11.0	291.49	292.06	292.40	288.56	285.69	285.10	279.64
G 12.0	292.39	293.51	294.26	290.47	287.54	286.80	280.89
G 13.0	293.44	295.17	296.32	292.67	289.88	288.94	282.70
G 14.0	294.39	296.87	298.68	295.32	292.28	291.14	284.40
G 15.0	295.19	298.48	301.09	297.93	294.77	293.23	285.90
G 16.0	295.29	300.28	303.65	300.43	297.06	295.08	287.10
G 17.0	294.45	301.78	305.76	302.68	299.25	296.68	288.00
G 18.0	291.75	302.29	307.72	304.88	301.25	298.27	289.00
G 19.0	287.52	301.91	309.62	306.99	303.29	299.72	289.70
G 20.0	281.48	300.08	311.18	309.04	305.18	301.11	290.30
G 21.0	274.40	297.05	311.98	310.79	306.98	302.41	291.05
G 22.0	266.07	292.62	312.13	312.64	308.82	303.90	291.75
G 23.0	256.94	286.73	311.28	314.24	310.47	305.45	292.50
G 24.0	247.11	279.98	309.22	315.49	312.41	306.75	293.20
G 25.0	237.28	272.83	306.41	316.24	314.25	308.34	294.20
G 26.0	226.55	264.63	302.19	316.70	316.05	310.09	295.00
G 27.0	215.47	255.97	297.02	316.40	317.84	311.83	295.90
G 28.0	204.09	246.92	290.99	315.41	319.64	313.53	297.05
G 29.0	192.96	237.86	284.81	313.61	321.33	315.22	298.15
G 30.0	181.04	228.06	277.68	311.21	322.78	317.17	299.35
G 31.0	169.11	218.00	270.30	307.91	323.93	319.07	300.70
G 32.0	156.84	207.74	262.42	303.96	324.68	320.76	302.05
G 33.0	145.01	197.49	254.43	299.61	325.08	322.56	303.30
G 34.0	132.78	186.48	245.89	294.26	324.99	324.46	304.90
G 35.0	120.70	175.17	237.01	288.40	324.49	326.15	306.46
G 36.0	109.07	163.96	227.56	282.30	323.50	327.75	308.01
G 37.0	98.59	153.05	218.17	276.04	322.06	329.50	309.81
G 38.0	89.30	141.33	208.13	268.99	319.97	331.09	311.56
G 39.0	82.06	129.91	197.84	261.68	317.24	332.49	313.41
G 40.0	76.66	119.14	187.24	254.27	313.95	333.58	315.10
G 41.0	72.82	109.55	176.80	246.66	310.31	334.23	316.60
G 42.0	69.47	100.81	165.75	238.05	305.88	334.43	317.95
G 43.0	66.23	93.61	154.55	229.09	300.59	334.23	319.14
G 44.0	62.89	87.87	143.50	220.03	294.71	333.24	319.84
G 45.0	59.59	83.30	132.81	210.12	288.48	331.69	320.13
G 46.0	56.45	79.35	123.37	200.21	281.70	329.75	320.27
G 47.0	53.11	75.19	114.53	189.30	273.82	327.16	320.12
G 48.0	49.96	70.99	106.70	178.28	265.40	323.63	319.66
G 49.0	46.97	66.83	99.82	166.87	256.57	319.59	318.71
G 50.0	44.22	62.83	94.20	155.70	247.50	315.16	317.96
G 51.0	41.48	58.72	88.83	144.29	236.98	309.48	317.21
G 52.0	38.93	54.87	83.45	133.72	225.67	303.30	316.51
G 53.0	36.64	51.32	78.08	123.74	214.05	296.22	315.41
G 54.0	34.54	47.96	73.01	114.57	201.99	287.95	314.02
G 55.0	32.59	44.76	67.69	105.50	188.23	278.02	311.82
G 56.0	30.75	41.85	62.62	97.44	173.87	267.10	307.78
G 57.0	29.10	39.15	57.90	89.68	159.57	254.53	299.82
G 58.0	27.70	36.69	53.58	82.22	145.75	239.90	288.26
G 59.0	26.40	34.24	49.26	74.51	131.54	222.72	274.54
G 60.0	25.21	32.03	45.24	67.36	118.07	205.39	259.56
G 61.0	24.26	29.92	41.53	60.70	105.64	188.41	246.85
G 62.0	23.51	28.17	38.16	54.99	94.87	171.64	236.86
G 63.0	22.91	26.46	34.90	49.83	84.24	154.62	228.22
G 64.0	22.41	25.00	32.04	45.58	75.21	141.39	221.83
G 65.0	22.11	23.90	29.52	41.92	68.73	131.96	216.85
G 66.0	21.86	23.04	27.52	38.92	64.10	124.43	212.46
G 67.0	21.86	22.39	25.66	36.11	60.21	117.35	207.38
G 68.0	21.96	22.03	24.25	33.71	57.22	111.26	201.93
G 69.0	22.20	21.73	23.15	31.46	55.02	106.12	195.33
G 70.0	22.55	21.63	22.34	29.20	53.18	100.82	187.77
G 71.0	22.80	21.62	21.69	26.80	50.93	95.16	178.55
G 72.0	23.10	21.57	21.04	24.39	48.09	89.36	164.77

Apparecchio		Rilievo		Lampada	
Codice	COMPASS 1 2Z8 S03 3.40-3M	Codice	20-187_0920	Codice	L-COM-2Z8-3000-400-3M-70-25
Nome	COMPASS 1 2Z8 S03 3.40-3M	Nome	COMPASS 1 2Z8 S03 3.40-3M	Numero	1
Archivio	Eulumdat	Data	06-11-2020	Posizione	

Flusso Apparecchio	8150.00 lm	Potenza Apparecchio	59.50 W	Efficacia	136.97 lm/W	Rendimento	100.00%
Flusso Lampade	8150.00 lm	Valore Massimo	534.82 cd/klm	Posizione	C=35.00 G=60.00	CG	Asimmetrico

Tabella Intensità Luminose - cd/klm Tabella 12/18

	C 325.00	C 330.00	C 335.00	C 340.00	C 345.00	C 350.00	C 355.00
G 73.0	23.10	21.57	20.39	22.24	44.50	83.40	149.69
G 74.0	22.90	21.51	19.78	20.13	39.82	76.75	134.03
G 75.0	22.10	21.26	19.28	18.38	34.03	69.44	117.16
G 76.0	21.26	20.96	19.13	16.82	27.59	59.44	98.30
G 77.0	20.11	20.16	18.98	15.52	21.75	47.86	78.74
G 78.0	18.76	19.31	18.53	14.52	17.06	35.67	58.34
G 79.0	17.07	18.11	17.73	13.71	13.62	25.49	41.06
G 80.0	14.92	16.22	16.37	12.96	11.12	17.09	27.98
G 81.0	12.43	14.02	14.96	12.06	9.32	11.45	18.86
G 82.0	9.73	11.47	13.01	10.76	7.92	7.70	12.39
G 83.0	7.39	8.81	10.54	9.06	6.63	5.20	7.83
G 84.0	5.19	6.26	7.68	6.81	5.28	3.45	4.72
G 85.0	3.44	4.06	5.02	4.36	3.69	2.25	2.81
G 86.0	2.20	2.36	2.76	2.35	2.09	1.20	1.61
G 87.0	1.20	1.10	1.36	1.05	0.90	0.65	0.85
G 88.0	0.45	0.40	0.50	0.25	0.30	0.30	0.45
G 89.0	0.10	0.10	0.10	0.10	0.15	0.15	0.25
G 90.0	0.00	0.00	0.00	0.00	0.00	0.00	0.00
G 91.0	0.00	0.00	0.00	0.00	0.00	0.00	0.00
G 92.0	0.00	0.00	0.00	0.00	0.00	0.00	0.00
G 93.0	0.00	0.00	0.00	0.00	0.00	0.00	0.00
G 94.0	0.00	0.00	0.00	0.00	0.00	0.00	0.00
G 95.0	0.00	0.00	0.00	0.00	0.00	0.00	0.00
G 96.0	0.00	0.00	0.00	0.00	0.00	0.00	0.00
G 97.0	0.00	0.00	0.00	0.00	0.00	0.00	0.00
G 98.0	0.00	0.00	0.00	0.00	0.00	0.00	0.00
G 99.0	0.00	0.00	0.00	0.00	0.00	0.00	0.00
G100.0	0.00	0.00	0.00	0.00	0.00	0.00	0.00
G101.0	0.00	0.00	0.00	0.00	0.00	0.00	0.00
G102.0	0.00	0.00	0.00	0.00	0.00	0.00	0.00
G103.0	0.00	0.00	0.00	0.00	0.00	0.00	0.00
G104.0	0.00	0.00	0.00	0.00	0.00	0.00	0.00
G105.0	0.00	0.00	0.00	0.00	0.00	0.00	0.00
G106.0	0.00	0.00	0.00	0.00	0.00	0.00	0.00
G107.0	0.00	0.00	0.00	0.00	0.00	0.00	0.00
G108.0	0.00	0.00	0.00	0.00	0.00	0.00	0.00
G109.0	0.00	0.00	0.00	0.00	0.00	0.00	0.00
G110.0	0.00	0.00	0.00	0.00	0.00	0.00	0.00
G111.0	0.00	0.00	0.00	0.00	0.00	0.00	0.00
G112.0	0.00	0.00	0.00	0.00	0.00	0.00	0.00
G113.0	0.00	0.00	0.00	0.00	0.00	0.00	0.00
G114.0	0.00	0.00	0.00	0.00	0.00	0.00	0.00
G115.0	0.00	0.00	0.00	0.00	0.00	0.00	0.00
G116.0	0.00	0.00	0.00	0.00	0.00	0.00	0.00
G117.0	0.00	0.00	0.00	0.00	0.00	0.00	0.00
G118.0	0.00	0.00	0.00	0.00	0.00	0.00	0.00
G119.0	0.00	0.00	0.00	0.00	0.00	0.00	0.00
G120.0	0.00	0.00	0.00	0.00	0.00	0.00	0.00
G121.0	0.00	0.00	0.00	0.00	0.00	0.00	0.00
G122.0	0.00	0.00	0.00	0.00	0.00	0.00	0.00
G123.0	0.00	0.00	0.00	0.00	0.00	0.00	0.00
G124.0	0.00	0.00	0.00	0.00	0.00	0.00	0.00
G125.0	0.00	0.00	0.00	0.00	0.00	0.00	0.00
G126.0	0.00	0.00	0.00	0.00	0.00	0.00	0.00
G127.0	0.00	0.00	0.00	0.00	0.00	0.00	0.00
G128.0	0.00	0.00	0.00	0.00	0.00	0.00	0.00
G129.0	0.00	0.00	0.00	0.00	0.00	0.00	0.00
G130.0	0.00	0.00	0.00	0.00	0.00	0.00	0.00
G131.0	0.00	0.00	0.00	0.00	0.00	0.00	0.00
G132.0	0.00	0.00	0.00	0.00	0.00	0.00	0.00
G133.0	0.00	0.00	0.00	0.00	0.00	0.00	0.00
G134.0	0.00	0.00	0.00	0.00	0.00	0.00	0.00
G135.0	0.00	0.00	0.00	0.00	0.00	0.00	0.00
G136.0	0.00	0.00	0.00	0.00	0.00	0.00	0.00
G137.0	0.00	0.00	0.00	0.00	0.00	0.00	0.00
G138.0	0.00	0.00	0.00	0.00	0.00	0.00	0.00
G139.0	0.00	0.00	0.00	0.00	0.00	0.00	0.00
G140.0	0.00	0.00	0.00	0.00	0.00	0.00	0.00
G141.0	0.00	0.00	0.00	0.00	0.00	0.00	0.00
G142.0	0.00	0.00	0.00	0.00	0.00	0.00	0.00
G143.0	0.00	0.00	0.00	0.00	0.00	0.00	0.00
G144.0	0.00	0.00	0.00	0.00	0.00	0.00	0.00
G145.0	0.00	0.00	0.00	0.00	0.00	0.00	0.00

Apparecchio		Rilievo		Lampada		
Codice	COMPASS 1 2Z8 S03 3.40-3M	Codice	20-187_0920	Codice	L-COM-2Z8-3000-400-3M-70-25	
Nome	COMPASS 1 2Z8 S03 3.40-3M	Nome	COMPASS 1 2Z8 S03 3.40-3M	Numero	1	
Archivio	Eulumdat	Data	06-11-2020	Posizione		

Flusso Apparecchio	8150.00 lm	Potenza Apparecchio	59.50 W	Efficacia	136.97 lm/W	Rendimento	100.00%
Flusso Lampade	8150.00 lm	Valore Massimo	534.82 cd/klm	Posizione	C=35.00 G=60.00	CG	Asimmetrico

Tabella Intensità Luminose - cd/klm Tabella 13/18

	C 0.00	C 5.00	C 10.00	C 15.00	C 20.00	C 25.00	C 30.00	C 35.00	C 40.00	C 45.00	C 50.00	C 55.00	C 60.00
G146.0	0.00	0.00	0.00	0.00	0.00	0.00	0.00	0.00	0.00	0.00	0.00	0.00	0.00
G147.0	0.00	0.00	0.00	0.00	0.00	0.00	0.00	0.00	0.00	0.00	0.00	0.00	0.00
G148.0	0.00	0.00	0.00	0.00	0.00	0.00	0.00	0.00	0.00	0.00	0.00	0.00	0.00
G149.0	0.00	0.00	0.00	0.00	0.00	0.00	0.00	0.00	0.00	0.00	0.00	0.00	0.00
G150.0	0.00	0.00	0.00	0.00	0.00	0.00	0.00	0.00	0.00	0.00	0.00	0.00	0.00
G151.0	0.00	0.00	0.00	0.00	0.00	0.00	0.00	0.00	0.00	0.00	0.00	0.00	0.00
G152.0	0.00	0.00	0.00	0.00	0.00	0.00	0.00	0.00	0.00	0.00	0.00	0.00	0.00
G153.0	0.00	0.00	0.00	0.00	0.00	0.00	0.00	0.00	0.00	0.00	0.00	0.00	0.00
G154.0	0.00	0.00	0.00	0.00	0.00	0.00	0.00	0.00	0.00	0.00	0.00	0.00	0.00
G155.0	0.00	0.00	0.00	0.00	0.00	0.00	0.00	0.00	0.00	0.00	0.00	0.00	0.00
G156.0	0.00	0.00	0.00	0.00	0.00	0.00	0.00	0.00	0.00	0.00	0.00	0.00	0.00
G157.0	0.00	0.00	0.00	0.00	0.00	0.00	0.00	0.00	0.00	0.00	0.00	0.00	0.00
G158.0	0.00	0.00	0.00	0.00	0.00	0.00	0.00	0.00	0.00	0.00	0.00	0.00	0.00
G159.0	0.00	0.00	0.00	0.00	0.00	0.00	0.00	0.00	0.00	0.00	0.00	0.00	0.00
G160.0	0.00	0.00	0.00	0.00	0.00	0.00	0.00	0.00	0.00	0.00	0.00	0.00	0.00
G161.0	0.00	0.00	0.00	0.00	0.00	0.00	0.00	0.00	0.00	0.00	0.00	0.00	0.00
G162.0	0.00	0.00	0.00	0.00	0.00	0.00	0.00	0.00	0.00	0.00	0.00	0.00	0.00
G163.0	0.00	0.00	0.00	0.00	0.00	0.00	0.00	0.00	0.00	0.00	0.00	0.00	0.00
G164.0	0.00	0.00	0.00	0.00	0.00	0.00	0.00	0.00	0.00	0.00	0.00	0.00	0.00
G165.0	0.00	0.00	0.00	0.00	0.00	0.00	0.00	0.00	0.00	0.00	0.00	0.00	0.00
G166.0	0.00	0.00	0.00	0.00	0.00	0.00	0.00	0.00	0.00	0.00	0.00	0.00	0.00
G167.0	0.00	0.00	0.00	0.00	0.00	0.00	0.00	0.00	0.00	0.00	0.00	0.00	0.00
G168.0	0.00	0.00	0.00	0.00	0.00	0.00	0.00	0.00	0.00	0.00	0.00	0.00	0.00
G169.0	0.00	0.00	0.00	0.00	0.00	0.00	0.00	0.00	0.00	0.00	0.00	0.00	0.00
G170.0	0.00	0.00	0.00	0.00	0.00	0.00	0.00	0.00	0.00	0.00	0.00	0.00	0.00
G171.0	0.00	0.00	0.00	0.00	0.00	0.00	0.00	0.00	0.00	0.00	0.00	0.00	0.00
G172.0	0.00	0.00	0.00	0.00	0.00	0.00	0.00	0.00	0.00	0.00	0.00	0.00	0.00
G173.0	0.00	0.00	0.00	0.00	0.00	0.00	0.00	0.00	0.00	0.00	0.00	0.00	0.00
G174.0	0.00	0.00	0.00	0.00	0.00	0.00	0.00	0.00	0.00	0.00	0.00	0.00	0.00
G175.0	0.00	0.00	0.00	0.00	0.00	0.00	0.00	0.00	0.00	0.00	0.00	0.00	0.00
G176.0	0.00	0.00	0.00	0.00	0.00	0.00	0.00	0.00	0.00	0.00	0.00	0.00	0.00
G177.0	0.00	0.00	0.00	0.00	0.00	0.00	0.00	0.00	0.00	0.00	0.00	0.00	0.00
G178.0	0.00	0.00	0.00	0.00	0.00	0.00	0.00	0.00	0.00	0.00	0.00	0.00	0.00
G179.0	0.00	0.00	0.00	0.00	0.00	0.00	0.00	0.00	0.00	0.00	0.00	0.00	0.00
G180.0	0.00	0.00	0.00	0.00	0.00	0.00	0.00	0.00	0.00	0.00	0.00	0.00	0.00

Apparecchio		Rilievo		Lampada		
Codice	COMPASS 1 2Z8 S03 3.40-3M	Codice	20-187_0920	Codice	L-COM-2Z8-3000-400-3M-70-25	
Nome	COMPASS 1 2Z8 S03 3.40-3M	Nome	COMPASS 1 2Z8 S03 3.40-3M	Numero	1	
Archivio	Eulumdat	Data	06-11-2020	Posizione		

Flusso Apparecchio	8150.00 lm	Potenza Apparecchio	59.50 W	Efficacia	136.97 lm/W	Rendimento	100.00%
Flusso Lampade	8150.00 lm	Valore Massimo	534.82 cd/klm	Posizione	C=35.00 G=60.00	CG	Asimmetrico

Tabella Intensità Luminose - cd/klm Tabella 14/18

	C 65.00	C 70.00	C 75.00	C 80.00	C 85.00	C 90.00	C 95.00	C 100.00	C 105.00	C 110.00	C 115.00	C 120.00	C 125.00
G146.0	0.00	0.00	0.00	0.00	0.00	0.00	0.00	0.00	0.00	0.00	0.00	0.00	0.00
G147.0	0.00	0.00	0.00	0.00	0.00	0.00	0.00	0.00	0.00	0.00	0.00	0.00	0.00
G148.0	0.00	0.00	0.00	0.00	0.00	0.00	0.00	0.00	0.00	0.00	0.00	0.00	0.00
G149.0	0.00	0.00	0.00	0.00	0.00	0.00	0.00	0.00	0.00	0.00	0.00	0.00	0.00
G150.0	0.00	0.00	0.00	0.00	0.00	0.00	0.00	0.00	0.00	0.00	0.00	0.00	0.00
G151.0	0.00	0.00	0.00	0.00	0.00	0.00	0.00	0.00	0.00	0.00	0.00	0.00	0.00
G152.0	0.00	0.00	0.00	0.00	0.00	0.00	0.00	0.00	0.00	0.00	0.00	0.00	0.00
G153.0	0.00	0.00	0.00	0.00	0.00	0.00	0.00	0.00	0.00	0.00	0.00	0.00	0.00
G154.0	0.00	0.00	0.00	0.00	0.00	0.00	0.00	0.00	0.00	0.00	0.00	0.00	0.00
G155.0	0.00	0.00	0.00	0.00	0.00	0.00	0.00	0.00	0.00	0.00	0.00	0.00	0.00
G156.0	0.00	0.00	0.00	0.00	0.00	0.00	0.00	0.00	0.00	0.00	0.00	0.00	0.00
G157.0	0.00	0.00	0.00	0.00	0.00	0.00	0.00	0.00	0.00	0.00	0.00	0.00	0.00
G158.0	0.00	0.00	0.00	0.00	0.00	0.00	0.00	0.00	0.00	0.00	0.00	0.00	0.00
G159.0	0.00	0.00	0.00	0.00	0.00	0.00	0.00	0.00	0.00	0.00	0.00	0.00	0.00
G160.0	0.00	0.00	0.00	0.00	0.00	0.00	0.00	0.00	0.00	0.00	0.00	0.00	0.00
G161.0	0.00	0.00	0.00	0.00	0.00	0.00	0.00	0.00	0.00	0.00	0.00	0.00	0.00
G162.0	0.00	0.00	0.00	0.00	0.00	0.00	0.00	0.00	0.00	0.00	0.00	0.00	0.00
G163.0	0.00	0.00	0.00	0.00	0.00	0.00	0.00	0.00	0.00	0.00	0.00	0.00	0.00
G164.0	0.00	0.00	0.00	0.00	0.00	0.00	0.00	0.00	0.00	0.00	0.00	0.00	0.00
G165.0	0.00	0.00	0.00	0.00	0.00	0.00	0.00	0.00	0.00	0.00	0.00	0.00	0.00
G166.0	0.00	0.00	0.00	0.00	0.00	0.00	0.00	0.00	0.00	0.00	0.00	0.00	0.00
G167.0	0.00	0.00	0.00	0.00	0.00	0.00	0.00	0.00	0.00	0.00	0.00	0.00	0.00
G168.0	0.00	0.00	0.00	0.00	0.00	0.00	0.00	0.00	0.00	0.00	0.00	0.00	0.00
G169.0	0.00	0.00	0.00	0.00	0.00	0.00	0.00	0.00	0.00	0.00	0.00	0.00	0.00
G170.0	0.00	0.00	0.00	0.00	0.00	0.00	0.00	0.00	0.00	0.00	0.00	0.00	0.00
G171.0	0.00	0.00	0.00	0.00	0.00	0.00	0.00	0.00	0.00	0.00	0.00	0.00	0.00
G172.0	0.00	0.00	0.00	0.00	0.00	0.00	0.00	0.00	0.00	0.00	0.00	0.00	0.00
G173.0	0.00	0.00	0.00	0.00	0.00	0.00	0.00	0.00	0.00	0.00	0.00	0.00	0.00
G174.0	0.00	0.00	0.00	0.00	0.00	0.00	0.00	0.00	0.00	0.00	0.00	0.00	0.00
G175.0	0.00	0.00	0.00	0.00	0.00	0.00	0.00	0.00	0.00	0.00	0.00	0.00	0.00
G176.0	0.00	0.00	0.00	0.00	0.00	0.00	0.00	0.00	0.00	0.00	0.00	0.00	0.00
G177.0	0.00	0.00	0.00	0.00	0.00	0.00	0.00	0.00	0.00	0.00	0.00	0.00	0.00
G178.0	0.00	0.00	0.00	0.00	0.00	0.00	0.00	0.00	0.00	0.00	0.00	0.00	0.00
G179.0	0.00	0.00	0.00	0.00	0.00	0.00	0.00	0.00	0.00	0.00	0.00	0.00	0.00
G180.0	0.00	0.00	0.00	0.00	0.00	0.00	0.00	0.00	0.00	0.00	0.00	0.00	0.00

Apparecchio		Rilievo		Lampada	
Codice	COMPASS 1 2Z8 S03 3.40-3M	Codice	20-187_0920	Codice	L-COM-2Z8-3000-400-3M-70-25
Nome	COMPASS 1 2Z8 S03 3.40-3M	Nome	COMPASS 1 2Z8 S03 3.40-3M	Numero	1
Archivio	Eulumdat	Data	06-11-2020	Posizione	

Flusso Apparecchio	8150.00 lm	Potenza Apparecchio	59.50 W	Efficacia	136.97 lm/W	Rendimento	100.00%
Flusso Lampade	8150.00 lm	Valore Massimo	534.82 cd/klm	Posizione	C=35.00 G=60.00	CG	Asimmetrico

Tabella Intensità Luminose - cd/klm Tabella 15/18

	C 130.00	C 135.00	C 140.00	C 145.00	C 150.00	C 155.00	C 160.00	C 165.00	C 170.00	C 175.00	C 180.00	C 185.00	C 190.00
G146.0	0.00	0.00	0.00	0.00	0.00	0.00	0.00	0.00	0.00	0.00	0.00	0.00	0.00
G147.0	0.00	0.00	0.00	0.00	0.00	0.00	0.00	0.00	0.00	0.00	0.00	0.00	0.00
G148.0	0.00	0.00	0.00	0.00	0.00	0.00	0.00	0.00	0.00	0.00	0.00	0.00	0.00
G149.0	0.00	0.00	0.00	0.00	0.00	0.00	0.00	0.00	0.00	0.00	0.00	0.00	0.00
G150.0	0.00	0.00	0.00	0.00	0.00	0.00	0.00	0.00	0.00	0.00	0.00	0.00	0.00
G151.0	0.00	0.00	0.00	0.00	0.00	0.00	0.00	0.00	0.00	0.00	0.00	0.00	0.00
G152.0	0.00	0.00	0.00	0.00	0.00	0.00	0.00	0.00	0.00	0.00	0.00	0.00	0.00
G153.0	0.00	0.00	0.00	0.00	0.00	0.00	0.00	0.00	0.00	0.00	0.00	0.00	0.00
G154.0	0.00	0.00	0.00	0.00	0.00	0.00	0.00	0.00	0.00	0.00	0.00	0.00	0.00
G155.0	0.00	0.00	0.00	0.00	0.00	0.00	0.00	0.00	0.00	0.00	0.00	0.00	0.00
G156.0	0.00	0.00	0.00	0.00	0.00	0.00	0.00	0.00	0.00	0.00	0.00	0.00	0.00
G157.0	0.00	0.00	0.00	0.00	0.00	0.00	0.00	0.00	0.00	0.00	0.00	0.00	0.00
G158.0	0.00	0.00	0.00	0.00	0.00	0.00	0.00	0.00	0.00	0.00	0.00	0.00	0.00
G159.0	0.00	0.00	0.00	0.00	0.00	0.00	0.00	0.00	0.00	0.00	0.00	0.00	0.00
G160.0	0.00	0.00	0.00	0.00	0.00	0.00	0.00	0.00	0.00	0.00	0.00	0.00	0.00
G161.0	0.00	0.00	0.00	0.00	0.00	0.00	0.00	0.00	0.00	0.00	0.00	0.00	0.00
G162.0	0.00	0.00	0.00	0.00	0.00	0.00	0.00	0.00	0.00	0.00	0.00	0.00	0.00
G163.0	0.00	0.00	0.00	0.00	0.00	0.00	0.00	0.00	0.00	0.00	0.00	0.00	0.00
G164.0	0.00	0.00	0.00	0.00	0.00	0.00	0.00	0.00	0.00	0.00	0.00	0.00	0.00
G165.0	0.00	0.00	0.00	0.00	0.00	0.00	0.00	0.00	0.00	0.00	0.00	0.00	0.00
G166.0	0.00	0.00	0.00	0.00	0.00	0.00	0.00	0.00	0.00	0.00	0.00	0.00	0.00
G167.0	0.00	0.00	0.00	0.00	0.00	0.00	0.00	0.00	0.00	0.00	0.00	0.00	0.00
G168.0	0.00	0.00	0.00	0.00	0.00	0.00	0.00	0.00	0.00	0.00	0.00	0.00	0.00
G169.0	0.00	0.00	0.00	0.00	0.00	0.00	0.00	0.00	0.00	0.00	0.00	0.00	0.00
G170.0	0.00	0.00	0.00	0.00	0.00	0.00	0.00	0.00	0.00	0.00	0.00	0.00	0.00
G171.0	0.00	0.00	0.00	0.00	0.00	0.00	0.00	0.00	0.00	0.00	0.00	0.00	0.00
G172.0	0.00	0.00	0.00	0.00	0.00	0.00	0.00	0.00	0.00	0.00	0.00	0.00	0.00
G173.0	0.00	0.00	0.00	0.00	0.00	0.00	0.00	0.00	0.00	0.00	0.00	0.00	0.00
G174.0	0.00	0.00	0.00	0.00	0.00	0.00	0.00	0.00	0.00	0.00	0.00	0.00	0.00
G175.0	0.00	0.00	0.00	0.00	0.00	0.00	0.00	0.00	0.00	0.00	0.00	0.00	0.00
G176.0	0.00	0.00	0.00	0.00	0.00	0.00	0.00	0.00	0.00	0.00	0.00	0.00	0.00
G177.0	0.00	0.00	0.00	0.00	0.00	0.00	0.00	0.00	0.00	0.00	0.00	0.00	0.00
G178.0	0.00	0.00	0.00	0.00	0.00	0.00	0.00	0.00	0.00	0.00	0.00	0.00	0.00
G179.0	0.00	0.00	0.00	0.00	0.00	0.00	0.00	0.00	0.00	0.00	0.00	0.00	0.00
G180.0	0.00	0.00	0.00	0.00	0.00	0.00	0.00	0.00	0.00	0.00	0.00	0.00	0.00

Apparecchio			Rilievo			Lampada			
Codice	COMPASS 1 2Z8 S03 3.40-3M		Codice	20-187_0920		Codice	L-COM-2Z8-3000-400-3M-70-25		
Nome	COMPASS 1 2Z8 S03 3.40-3M		Nome	COMPASS 1 2Z8 S03 3.40-3M		Numero	1		
Archivio	Eulumdat		Data	06-11-2020		Posizione			

Flusso Apparecchio	8150.00 lm	Potenza Apparecchio	59.50 W	Efficacia	136.97 lm/W	Rendimento	100.00%
Flusso Lampade	8150.00 lm	Valore Massimo	534.82 cd/klm	Posizione	C=35.00 G=60.00	CG	Asimmetrico

Tabella Intensità Luminose - cd/klm Tabella 16/18

	C 195.00	C 200.00	C 205.00	C 210.00	C 215.00	C 220.00	C 225.00	C 230.00	C 235.00	C 240.00	C 245.00	C 250.00	C 255.00
G146.0	0.00	0.00	0.00	0.00	0.00	0.00	0.00	0.00	0.00	0.00	0.00	0.00	0.00
G147.0	0.00	0.00	0.00	0.00	0.00	0.00	0.00	0.00	0.00	0.00	0.00	0.00	0.00
G148.0	0.00	0.00	0.00	0.00	0.00	0.00	0.00	0.00	0.00	0.00	0.00	0.00	0.00
G149.0	0.00	0.00	0.00	0.00	0.00	0.00	0.00	0.00	0.00	0.00	0.00	0.00	0.00
G150.0	0.00	0.00	0.00	0.00	0.00	0.00	0.00	0.00	0.00	0.00	0.00	0.00	0.00
G151.0	0.00	0.00	0.00	0.00	0.00	0.00	0.00	0.00	0.00	0.00	0.00	0.00	0.00
G152.0	0.00	0.00	0.00	0.00	0.00	0.00	0.00	0.00	0.00	0.00	0.00	0.00	0.00
G153.0	0.00	0.00	0.00	0.00	0.00	0.00	0.00	0.00	0.00	0.00	0.00	0.00	0.00
G154.0	0.00	0.00	0.00	0.00	0.00	0.00	0.00	0.00	0.00	0.00	0.00	0.00	0.00
G155.0	0.00	0.00	0.00	0.00	0.00	0.00	0.00	0.00	0.00	0.00	0.00	0.00	0.00
G156.0	0.00	0.00	0.00	0.00	0.00	0.00	0.00	0.00	0.00	0.00	0.00	0.00	0.00
G157.0	0.00	0.00	0.00	0.00	0.00	0.00	0.00	0.00	0.00	0.00	0.00	0.00	0.00
G158.0	0.00	0.00	0.00	0.00	0.00	0.00	0.00	0.00	0.00	0.00	0.00	0.00	0.00
G159.0	0.00	0.00	0.00	0.00	0.00	0.00	0.00	0.00	0.00	0.00	0.00	0.00	0.00
G160.0	0.00	0.00	0.00	0.00	0.00	0.00	0.00	0.00	0.00	0.00	0.00	0.00	0.00
G161.0	0.00	0.00	0.00	0.00	0.00	0.00	0.00	0.00	0.00	0.00	0.00	0.00	0.00
G162.0	0.00	0.00	0.00	0.00	0.00	0.00	0.00	0.00	0.00	0.00	0.00	0.00	0.00
G163.0	0.00	0.00	0.00	0.00	0.00	0.00	0.00	0.00	0.00	0.00	0.00	0.00	0.00
G164.0	0.00	0.00	0.00	0.00	0.00	0.00	0.00	0.00	0.00	0.00	0.00	0.00	0.00
G165.0	0.00	0.00	0.00	0.00	0.00	0.00	0.00	0.00	0.00	0.00	0.00	0.00	0.00
G166.0	0.00	0.00	0.00	0.00	0.00	0.00	0.00	0.00	0.00	0.00	0.00	0.00	0.00
G167.0	0.00	0.00	0.00	0.00	0.00	0.00	0.00	0.00	0.00	0.00	0.00	0.00	0.00
G168.0	0.00	0.00	0.00	0.00	0.00	0.00	0.00	0.00	0.00	0.00	0.00	0.00	0.00
G169.0	0.00	0.00	0.00	0.00	0.00	0.00	0.00	0.00	0.00	0.00	0.00	0.00	0.00
G170.0	0.00	0.00	0.00	0.00	0.00	0.00	0.00	0.00	0.00	0.00	0.00	0.00	0.00
G171.0	0.00	0.00	0.00	0.00	0.00	0.00	0.00	0.00	0.00	0.00	0.00	0.00	0.00
G172.0	0.00	0.00	0.00	0.00	0.00	0.00	0.00	0.00	0.00	0.00	0.00	0.00	0.00
G173.0	0.00	0.00	0.00	0.00	0.00	0.00	0.00	0.00	0.00	0.00	0.00	0.00	0.00
G174.0	0.00	0.00	0.00	0.00	0.00	0.00	0.00	0.00	0.00	0.00	0.00	0.00	0.00
G175.0	0.00	0.00	0.00	0.00	0.00	0.00	0.00	0.00	0.00	0.00	0.00	0.00	0.00
G176.0	0.00	0.00	0.00	0.00	0.00	0.00	0.00	0.00	0.00	0.00	0.00	0.00	0.00
G177.0	0.00	0.00	0.00	0.00	0.00	0.00	0.00	0.00	0.00	0.00	0.00	0.00	0.00
G178.0	0.00	0.00	0.00	0.00	0.00	0.00	0.00	0.00	0.00	0.00	0.00	0.00	0.00
G179.0	0.00	0.00	0.00	0.00	0.00	0.00	0.00	0.00	0.00	0.00	0.00	0.00	0.00
G180.0	0.00	0.00	0.00	0.00	0.00	0.00	0.00	0.00	0.00	0.00	0.00	0.00	0.00

Apparecchio			Rilievo			Lampada			
Codice	COMPASS 1 2Z8 S03 3.40-3M		Codice	20-187_0920		Codice	L-COM-2Z8-3000-400-3M-70-25		
Nome	COMPASS 1 2Z8 S03 3.40-3M		Nome	COMPASS 1 2Z8 S03 3.40-3M		Numero	1		
Archivio	Eulumdat		Data	06-11-2020		Posizione			

Flusso Apparecchio	8150.00 lm	Potenza Apparecchio	59.50 W	Efficacia	136.97 lm/W	Rendimento	100.00%
Flusso Lampade	8150.00 lm	Valore Massimo	534.82 cd/klm	Posizione	C=35.00 G=60.00	CG	Asimmetrico

Tabella Intensità Luminose - cd/klm Tabella 17/18

	C 260.00	C 265.00	C 270.00	C 275.00	C 280.00	C 285.00	C 290.00	C 295.00	C 300.00	C 305.00	C 310.00	C 315.00	C 320.00
G146.0	0.00	0.00	0.00	0.00	0.00	0.00	0.00	0.00	0.00	0.00	0.00	0.00	0.00
G147.0	0.00	0.00	0.00	0.00	0.00	0.00	0.00	0.00	0.00	0.00	0.00	0.00	0.00
G148.0	0.00	0.00	0.00	0.00	0.00	0.00	0.00	0.00	0.00	0.00	0.00	0.00	0.00
G149.0	0.00	0.00	0.00	0.00	0.00	0.00	0.00	0.00	0.00	0.00	0.00	0.00	0.00
G150.0	0.00	0.00	0.00	0.00	0.00	0.00	0.00	0.00	0.00	0.00	0.00	0.00	0.00
G151.0	0.00	0.00	0.00	0.00	0.00	0.00	0.00	0.00	0.00	0.00	0.00	0.00	0.00
G152.0	0.00	0.00	0.00	0.00	0.00	0.00	0.00	0.00	0.00	0.00	0.00	0.00	0.00
G153.0	0.00	0.00	0.00	0.00	0.00	0.00	0.00	0.00	0.00	0.00	0.00	0.00	0.00
G154.0	0.00	0.00	0.00	0.00	0.00	0.00	0.00	0.00	0.00	0.00	0.00	0.00	0.00
G155.0	0.00	0.00	0.00	0.00	0.00	0.00	0.00	0.00	0.00	0.00	0.00	0.00	0.00
G156.0	0.00	0.00	0.00	0.00	0.00	0.00	0.00	0.00	0.00	0.00	0.00	0.00	0.00
G157.0	0.00	0.00	0.00	0.00	0.00	0.00	0.00	0.00	0.00	0.00	0.00	0.00	0.00
G158.0	0.00	0.00	0.00	0.00	0.00	0.00	0.00	0.00	0.00	0.00	0.00	0.00	0.00
G159.0	0.00	0.00	0.00	0.00	0.00	0.00	0.00	0.00	0.00	0.00	0.00	0.00	0.00
G160.0	0.00	0.00	0.00	0.00	0.00	0.00	0.00	0.00	0.00	0.00	0.00	0.00	0.00
G161.0	0.00	0.00	0.00	0.00	0.00	0.00	0.00	0.00	0.00	0.00	0.00	0.00	0.00
G162.0	0.00	0.00	0.00	0.00	0.00	0.00	0.00	0.00	0.00	0.00	0.00	0.00	0.00
G163.0	0.00	0.00	0.00	0.00	0.00	0.00	0.00	0.00	0.00	0.00	0.00	0.00	0.00
G164.0	0.00	0.00	0.00	0.00	0.00	0.00	0.00	0.00	0.00	0.00	0.00	0.00	0.00
G165.0	0.00	0.00	0.00	0.00	0.00	0.00	0.00	0.00	0.00	0.00	0.00	0.00	0.00
G166.0	0.00	0.00	0.00	0.00	0.00	0.00	0.00	0.00	0.00	0.00	0.00	0.00	0.00
G167.0	0.00	0.00	0.00	0.00	0.00	0.00	0.00	0.00	0.00	0.00	0.00	0.00	0.00
G168.0	0.00	0.00	0.00	0.00	0.00	0.00	0.00	0.00	0.00	0.00	0.00	0.00	0.00
G169.0	0.00	0.00	0.00	0.00	0.00	0.00	0.00	0.00	0.00	0.00	0.00	0.00	0.00
G170.0	0.00	0.00	0.00	0.00	0.00	0.00	0.00	0.00	0.00	0.00	0.00	0.00	0.00
G171.0	0.00	0.00	0.00	0.00	0.00	0.00	0.00	0.00	0.00	0.00	0.00	0.00	0.00
G172.0	0.00	0.00	0.00	0.00	0.00	0.00	0.00	0.00	0.00	0.00	0.00	0.00	0.00
G173.0	0.00	0.00	0.00	0.00	0.00	0.00	0.00	0.00	0.00	0.00	0.00	0.00	0.00
G174.0	0.00	0.00	0.00	0.00	0.00	0.00	0.00	0.00	0.00	0.00	0.00	0.00	0.00
G175.0	0.00	0.00	0.00	0.00	0.00	0.00	0.00	0.00	0.00	0.00	0.00	0.00	0.00
G176.0	0.00	0.00	0.00	0.00	0.00	0.00	0.00	0.00	0.00	0.00	0.00	0.00	0.00
G177.0	0.00	0.00	0.00	0.00	0.00	0.00	0.00	0.00	0.00	0.00	0.00	0.00	0.00
G178.0	0.00	0.00	0.00	0.00	0.00	0.00	0.00	0.00	0.00	0.00	0.00	0.00	0.00
G179.0	0.00	0.00	0.00	0.00	0.00	0.00	0.00	0.00	0.00	0.00	0.00	0.00	0.00
G180.0	0.00	0.00	0.00	0.00	0.00	0.00	0.00	0.00	0.00	0.00	0.00	0.00	0.00

Apparecchio		Rilievo		Lampada		
Codice	COMPASS 1 2Z8 S03 3.40-3M	Codice	20-187_0920	Codice	L-COM-2Z8-3000-400-3M-70-25	
Nome	COMPASS 1 2Z8 S03 3.40-3M	Nome	COMPASS 1 2Z8 S03 3.40-3M	Numero	1	
Archivio	Eulumdat	Data	06-11-2020	Posizione		

Flusso Apparecchio	8150.00 lm	Potenza Apparecchio	59.50 W	Efficacia	136.97 lm/W	Rendimento	100.00%
Flusso Lampade	8150.00 lm	Valore Massimo	534.82 cd/klm	Posizione	C=35.00 G=60.00	CG	Asimmetrico

Tabella Intensità Luminosa - cd/klm Tabella 18/18

	C 325.00	C 330.00	C 335.00	C 340.00	C 345.00	C 350.00	C 355.00
G146.0	0.00	0.00	0.00	0.00	0.00	0.00	0.00
G147.0	0.00	0.00	0.00	0.00	0.00	0.00	0.00
G148.0	0.00	0.00	0.00	0.00	0.00	0.00	0.00
G149.0	0.00	0.00	0.00	0.00	0.00	0.00	0.00
G150.0	0.00	0.00	0.00	0.00	0.00	0.00	0.00
G151.0	0.00	0.00	0.00	0.00	0.00	0.00	0.00
G152.0	0.00	0.00	0.00	0.00	0.00	0.00	0.00
G153.0	0.00	0.00	0.00	0.00	0.00	0.00	0.00
G154.0	0.00	0.00	0.00	0.00	0.00	0.00	0.00
G155.0	0.00	0.00	0.00	0.00	0.00	0.00	0.00
G156.0	0.00	0.00	0.00	0.00	0.00	0.00	0.00
G157.0	0.00	0.00	0.00	0.00	0.00	0.00	0.00
G158.0	0.00	0.00	0.00	0.00	0.00	0.00	0.00
G159.0	0.00	0.00	0.00	0.00	0.00	0.00	0.00
G160.0	0.00	0.00	0.00	0.00	0.00	0.00	0.00
G161.0	0.00	0.00	0.00	0.00	0.00	0.00	0.00
G162.0	0.00	0.00	0.00	0.00	0.00	0.00	0.00
G163.0	0.00	0.00	0.00	0.00	0.00	0.00	0.00
G164.0	0.00	0.00	0.00	0.00	0.00	0.00	0.00
G165.0	0.00	0.00	0.00	0.00	0.00	0.00	0.00
G166.0	0.00	0.00	0.00	0.00	0.00	0.00	0.00
G167.0	0.00	0.00	0.00	0.00	0.00	0.00	0.00
G168.0	0.00	0.00	0.00	0.00	0.00	0.00	0.00
G169.0	0.00	0.00	0.00	0.00	0.00	0.00	0.00
G170.0	0.00	0.00	0.00	0.00	0.00	0.00	0.00
G171.0	0.00	0.00	0.00	0.00	0.00	0.00	0.00
G172.0	0.00	0.00	0.00	0.00	0.00	0.00	0.00
G173.0	0.00	0.00	0.00	0.00	0.00	0.00	0.00
G174.0	0.00	0.00	0.00	0.00	0.00	0.00	0.00
G175.0	0.00	0.00	0.00	0.00	0.00	0.00	0.00
G176.0	0.00	0.00	0.00	0.00	0.00	0.00	0.00
G177.0	0.00	0.00	0.00	0.00	0.00	0.00	0.00
G178.0	0.00	0.00	0.00	0.00	0.00	0.00	0.00
G179.0	0.00	0.00	0.00	0.00	0.00	0.00	0.00
G180.0	0.00	0.00	0.00	0.00	0.00	0.00	0.00

Apparecchio		Rilievo		Lampada	
Codice	COMPASS 1 2Z8 S03 3.40-3M	Codice	20-187_0920	Codice	L-COM-2Z8-3000-400-3M-70-25
Nome	COMPASS 1 2Z8 S03 3.40-3M	Nome	COMPASS 1 2Z8 S03 3.40-3M	Numero	1
Archivio	Eulumdat	Data	06-11-2020	Posizione	

Flusso Apparecchio	8150.00 lm	Potenza Apparecchio	59.50 W	Efficacia	136.97 lm/W	Rendimento	100.00%
Flusso Lampade	8150.00 lm	Valore Massimo	534.82 cd/klm	Posizione	C=35.00 G=60.00	CG	Asimmetrico
Apparecchio Circolare		Diam.	540 mm	Alt.	85 mm	Alt.	0 mm
Area Luminosa Rettangolare		Lung.	135 mm	Larg.	225 mm		
Area Luminosa Orizzontale	0.030375 m2			Area Luminosa Piano 180°	0.000000 m2		
Area Luminosa Piano 0°	0.000000 m2			Area Luminosa Piano 270°	0.000000 m2		
Area Luminosa Piano 90°	0.000000 m2			Area Luminosa a 76°	0.007348 m2		
Sistema Coordinate	CG			Tipo di Simmetria	Asimmetrico		
Data	06-11-2020			Massimo Angolo Gamma	180		

Lampade Apparecchio					
Archivio	Codice	Nome	Flusso [lm]	Pot. [W]	Q.tà
	L-COM-2Z8-3000-400-3M-70-25	L-COM-2Z8-3000-400-3M-70-25 - 59.50 W	8150.00	59.50	1
C.I.E.	36 74 97 100 100	D DIN 5040	A20		
F UTE	1.00 H	B NBN	BZ 6 / 1 / BZ 5		

Diam=540mm

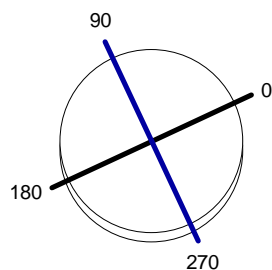

Semipiani C



ULOR	0.00 %
DLOR	100.00 %
RN	0.00 %

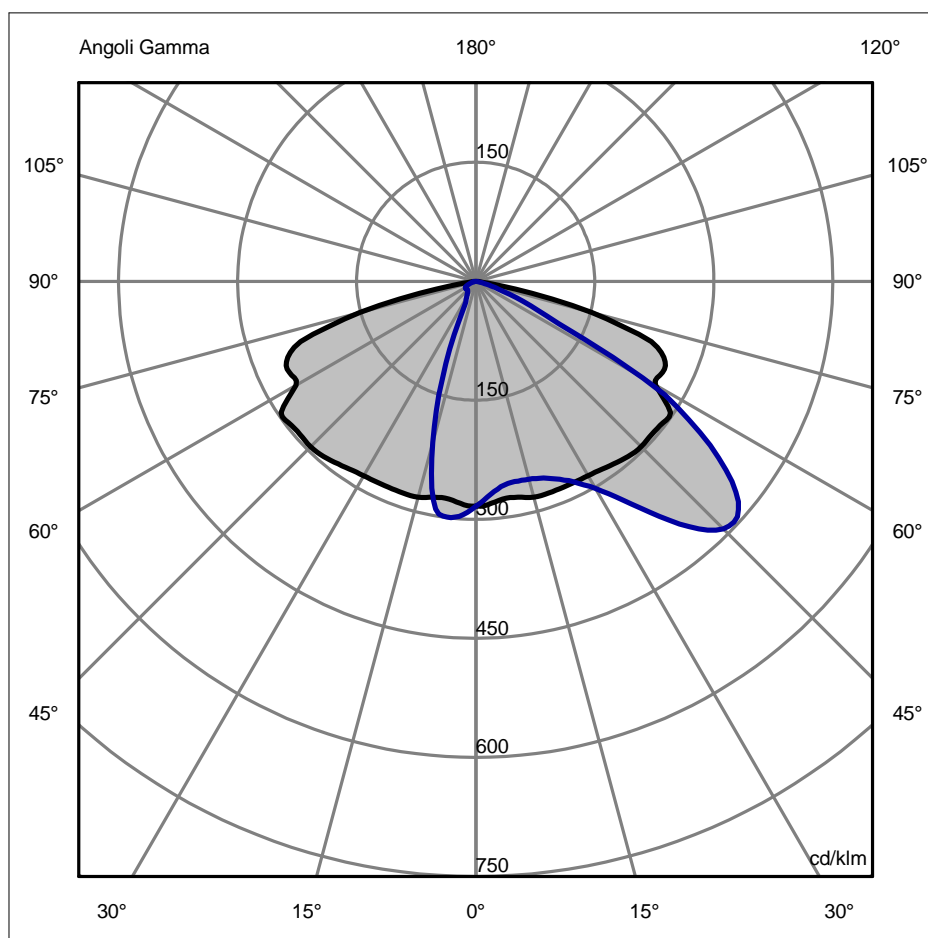

Apparecchio		Rilievo		Lampada	
Codice	COMPASS 1 2Z8 S03 3.40-3M	Codice	20-187_0920	Codice	L-COM-2Z8-3000-400-3M-70-25
Nome	COMPASS 1 2Z8 S03 3.40-3M	Nome	COMPASS 1 2Z8 S03 3.40-3M	Numero	1
Archivio	Eulumdat	Data	06-11-2020	Posizione	

Flusso Apparecchio	8150.00 lm	Potenza Apparecchio	59.50 W	Efficacia	136.97 lm/W	Rendimento	100.00%
Flusso Lampade	8150.00 lm	Valore Massimo	534.82 cd/klm	Posizione	C=35.00 G=60.00	CG	Asimmetrico

Marciapiede			Strada		
Piano	0	0.00%	Piano	0	0.00%
Piano	-5	4.91%	Piano	5	4.62%
Piano	-10	10.02%	Piano	10	9.11%
Piano	-15	14.64%	Piano	15	13.70%
Piano	-20	17.94%	Piano	20	18.50%
Piano	-25	19.79%	Piano	25	23.61%
Piano	-30	20.83%	Piano	30	29.16%
Piano	-35	21.55%	Piano	35	35.27%
Piano	-40	22.07%	Piano	40	42.09%
Piano	-45	22.47%	Piano	45	49.57%
Piano	-50	22.82%	Piano	50	57.22%
Piano	-55	23.14%	Piano	55	64.28%
Piano	-60	23.47%	Piano	60	70.10%
Piano	-65	23.77%	Piano	65	73.63%
Piano	-70	24.03%	Piano	70	75.11%
Piano	-75	24.21%	Piano	75	75.52%
Piano	-80	24.30%	Piano	80	75.64%
Piano	-85	24.33%	Piano	85	75.66%
Piano	-90	24.33%	Piano	90	75.67%

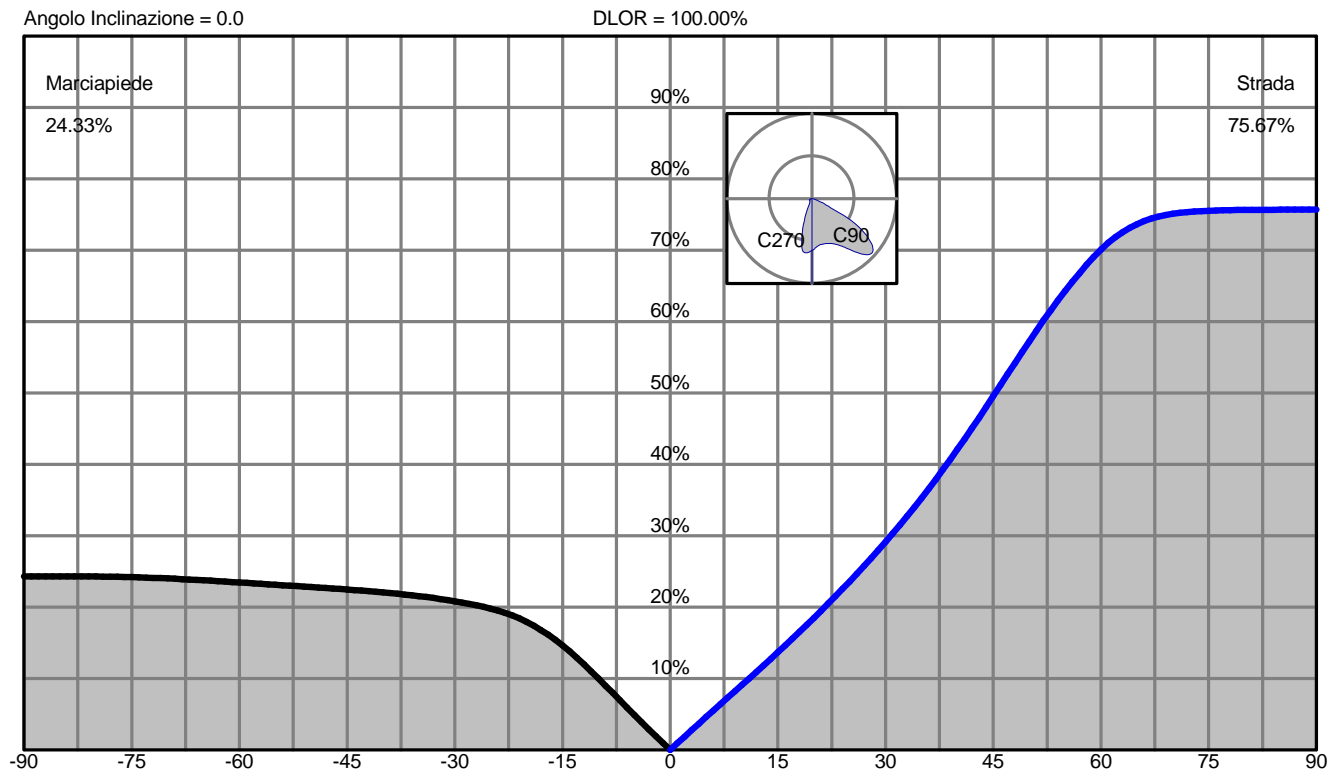

Spread	53.5° Medio	DLOR	100.00000 %
Throw	59.7° Corto	ULOR	0.00000 %
SLI	4.6 Ristretto	Rendimento	100.00000 %
Cutoff CIE	Semi Cutoff - Max: C=35.0° Gamma=60.0°	RN	0.00000 %
Cutoff Iesna	Full Cutoff	Classe Intensità Luminosa	G4
DIN5044	KB2	Indice Abbagliamento	D5
IESNA Type III Short Asymmetrical			

Photometric Test Report



Costruttore	AEC ILLUMINAZIONE SRL
Tipo di prodotto	Outdoor Lighting Luminaire
Codice fotometria	COMPASS 1 2Z8 STU-M 3.40-2M
Codice apparecchio	COMPASS 1 2Z8 STU-M 3.40-2M
Rilievo fotometrico	20-187_0920
Descrizione apparecchio	COMPASS 1 2Z8 STU-M 3.40-2M
Data emissione	06-11-2020

Foto del prodotto



Responsabile laboratorio fotometrico	Luca Vagheggi	
Tecnico laboratorio che ha eseguito la misura	Alessio Vagheggi	



Sommario e Allegati

Sommario	Dati apparecchio	
	Normative di riferimento	
	Procedure di riferimento	
	Condizioni di prova	
	Risultati fotometrici	
	Lista strumentazione	
	Incertezza strumentale	
Allegati	Dati Generali	X
	Tabella fotometrica delle Intensità (cd/Klm)	X
	Tabella fotometrica delle Intensità (cd)	
	Diagramma Polare	
	Diagramma Cartesiano	
	Valutazione UGR	
	Diagramma Sollner Abbagliamento	
	Flusso Zonale	
	Coefficienti di Utilizzazione	
	Isolux Unitario	
	Isocandele Percentuale	
	Tabella e Diagramma Luminanza	
	Classificazione Strade	X
Classificazione Strade IES TM-15		

DATI APPARECCHIO

Geometria apparecchio	Circolare		
Dimensioni apparecchio (mm)	Lunghezza / Diametro	Larghezza	Altezza
	540	540	85
Dimensioni area luminosa (mm)	Lunghezza / Diametro	Larghezza	Altezza C0
	95	225	0
	Altezza C90	Altezza C180	Altezza C270
	0	0	0
Tipo sorgente	LED		
Modello sorgente	Luxeon 5050s		
Tipo Alimentatore	Elettronico / Electronic		
Modello Alimentatore	Philips Xi		

NORMATIVE DI RIFERIMENTO

Normative di riferimento	UNI EN 13032-1:2012 UNI EN 13032-4:2015
Valutazione luce parassita	In accordo con Annex A UNI EN 13032-1

PROCEDURE DI RIFERIMENTO

Procedure di riferimento	I-QL-009
--------------------------	----------

CONDIZIONI DI PROVA

Laboratorio fotometrico	Interno AEC ILLUMINAZIONE srl, in regime di sistema di qualità aziendale certificato ISO 9001:2008, autorizzato UL	
Condizioni Ambientali	Temperatura ambiente (°C)	25
	Umidità relativa (°RH)	< 60
	Movimento aria (m/s)	< 0.2
Condizioni Elettriche	Tensione di alimentazione (V)	230
	Frequenza di alimentazione (Hz)	50
	Distorsione armonica THD V (%)	< 0.5%
Condizioni Preliminari Prova	Metodo di misura	Goniofotometro
	Sistema di riferimento misura	Sistema C-γ (Gonio)
	Posizione di misura	Verticale (Gonio)
	Distanza di misura (m)	9.03
	Tempo di stabilizzazione (min)	> 60
	Instabilità sorgente (%)	< 0.5%

I risultati delle verifiche e prove qui riportati, si riferiscono esclusivamente agli esemplari esaminati e descritti nella presente Relazione. L'estensione del riferimento ad esemplari che non siano quelli sottoposti alle verifiche descritte in seguito esula dallo scopo delle verifiche stesse. E' vietata la riproduzione integrale o parziale senza l'autorizzazione scritta di Aec illuminazione srl. L'immagine dell'apparecchio nella prima pagina è puramente indicativa della tipologia di apparecchio sottoposto a test.

RISULTATI FOTOMETRICI

Tipo di misura fotometrica	Assoluta
LOR (%)	100.0
Flusso luminoso apparecchio (lm)	5590
Potenza ingresso apparecchio (W)	40.5
Efficienza apparecchio (lm/W)	138
Note e commenti	

LISTA STRUMENTAZIONE

CODICE AEC	STRUMENTO	COSTRUTTORE	MODELLO
Q129	Luxmetro	Czibula&Grundmann	100310
Q130	Goniofotometro	Oxytech	T2
Q131	Termoigrometro	Delta Ohm	HD2001
Q132	Wattmetro	N4L	PPA2510
Q135	Stabilizzatore	Elettrotest	TPS/M/9KW
Q205	Luxmetro	Czibula&Grundmann	161206

INCERTEZZA STRUMENTALE

Encoder goniofotometro Oxytech T2	Precisione angolare in C – gamma	$\pm 0.044^\circ$
Luxmetro C&G	f1'	< 1.23%
Wattmetro Kinetiq N4L PPA2510	Accuratezza di potenza	< [0.05% + 0.03%/pf + (0.01%/kHz)/pf] Rdg + 0.05%VA Rng

Apparecchio	Rilievo	Lampada
Codice COMPASS 1 2Z8 STU-M 3.40-2M	Codice 20-187_0920	Codice L-COM-2Z8-3000-400-2M-70-25
Nome COMPASS 1 2Z8 STU-M 3.40-2M	Nome COMPASS 1 2Z8 STU-M 3.40-2M	Numero 1
Archivio Eulumdat	Data 06-11-2020	Posizione

Flusso Apparecchio	5590.00 lm	Potenza Apparecchio	40.50 W	Efficacia	138.02 lm/W	Rendimento	100.00%
Flusso Lampade	5590.00 lm	Valore Massimo	532.68 cd/klm	Posizione	C=15.00 G=66.00	CG	Asimmetrico

Tabella Intensità Luminose - cd/klm Tabella 6/18

	C 325.00	C 330.00	C 335.00	C 340.00	C 345.00	C 350.00	C 355.00
G 0.0	320.25	320.25	320.25	320.25	320.25	320.25	320.25
G 1.0	316.73	316.75	318.05	317.20	318.79	318.64	319.30
G 2.0	311.86	312.76	313.84	313.69	315.62	316.49	317.00
G 3.0	306.53	308.66	310.00	310.69	313.11	314.18	315.80
G 4.0	302.41	304.57	307.35	308.49	311.91	312.98	315.80
G 5.0	299.00	302.42	305.65	308.39	312.01	314.09	317.15
G 6.0	296.70	300.38	305.21	307.89	313.32	315.80	319.80
G 7.0	295.44	300.13	305.26	309.00	315.28	318.76	323.41
G 8.0	294.59	299.84	305.86	309.95	317.50	321.46	327.16
G 9.0	294.34	299.79	306.61	311.50	319.61	324.37	331.02
G 10.0	294.04	300.14	307.01	313.35	321.47	327.28	334.27
G 11.0	294.09	299.69	307.21	313.35	322.77	329.24	337.17
G 12.0	293.84	300.04	307.21	313.70	323.28	330.89	339.23
G 13.0	293.59	299.34	306.61	312.75	323.27	330.98	340.68
G 14.0	293.04	298.74	305.41	312.00	322.07	331.13	340.93
G 15.0	292.03	297.49	303.80	310.59	320.35	329.62	340.33
G 16.0	290.47	295.84	301.65	308.14	317.59	327.72	338.72
G 17.0	288.66	293.94	299.25	305.39	314.67	325.31	336.82
G 18.0	286.30	290.99	296.20	301.28	311.15	321.95	334.62
G 19.0	283.29	288.35	293.10	298.38	307.48	318.89	331.96
G 20.0	279.92	285.00	290.00	294.87	304.12	315.43	329.56
G 21.0	276.65	282.20	286.95	292.22	300.95	312.97	327.41
G 22.0	272.99	278.81	283.90	289.32	298.18	309.96	325.45
G 23.0	269.27	275.56	281.19	286.41	295.41	307.65	323.65
G 24.0	265.70	272.46	278.59	284.26	293.20	305.24	321.60
G 25.0	262.33	269.42	276.29	282.05	291.14	302.78	320.04
G 26.0	258.97	266.92	274.04	280.50	289.07	300.87	318.19
G 27.0	255.65	263.77	271.83	278.59	287.41	298.66	316.79
G 28.0	252.28	261.37	269.48	276.79	285.65	297.26	315.43
G 29.0	249.01	258.62	267.42	274.93	284.49	295.70	314.78
G 30.0	244.73	255.82	265.22	273.23	283.23	294.84	314.33
G 31.0	239.25	252.77	262.82	271.82	282.43	293.99	314.23
G 32.0	231.75	249.68	260.52	270.32	281.67	293.68	314.33
G 33.0	222.55	246.43	258.21	269.26	281.16	293.58	314.68
G 34.0	211.74	241.88	255.91	267.81	281.06	293.57	315.57
G 35.0	199.03	236.43	253.50	266.60	280.55	294.17	316.12
G 36.0	186.31	228.73	250.95	265.15	280.55	294.41	317.22
G 37.0	172.75	220.28	247.95	263.94	280.30	295.06	317.72
G 38.0	158.83	209.94	244.44	262.49	280.19	295.36	318.67
G 39.0	144.52	198.70	239.98	260.88	279.99	296.05	319.52
G 40.0	130.35	186.77	234.07	259.18	279.58	296.80	320.47
G 41.0	117.14	174.53	227.21	257.02	279.23	297.30	321.47
G 42.0	102.53	161.75	218.60	255.07	278.52	298.15	322.52
G 43.0	88.72	148.27	208.99	252.56	277.67	298.60	323.52
G 44.0	74.41	135.38	198.14	249.56	276.31	299.35	324.57
G 45.0	61.96	121.81	186.89	245.35	275.20	299.95	326.02
G 46.0	51.27	109.27	175.64	240.09	273.90	300.55	327.58
G 47.0	42.70	95.65	163.64	233.73	272.29	300.80	329.18
G 48.0	37.19	82.17	151.09	225.76	270.53	301.20	331.08
G 49.0	33.53	69.79	138.05	217.55	268.42	301.85	333.38
G 50.0	31.58	59.32	125.65	208.09	266.86	302.61	336.04
G 51.0	29.87	50.89	112.41	198.13	264.55	303.61	339.69
G 52.0	28.42	44.76	100.01	187.12	261.98	304.76	343.74
G 53.0	27.01	41.02	87.72	175.76	258.61	305.86	348.35
G 54.0	25.91	38.38	76.93	164.95	254.38	306.61	351.70
G 55.0	24.91	36.34	67.44	153.28	248.39	305.95	353.70
G 56.0	24.20	34.29	60.25	141.72	239.89	302.98	352.84
G 57.0	23.70	32.60	55.31	129.21	228.87	297.15	350.23
G 58.0	23.50	31.15	51.82	116.99	216.39	290.07	346.88
G 59.0	23.50	30.10	48.57	104.68	201.86	281.89	343.77
G 60.0	23.50	29.20	45.42	94.08	187.79	275.13	342.92
G 61.0	23.70	28.80	42.57	85.78	174.68	270.42	344.38
G 62.0	24.00	28.50	40.53	79.48	164.47	268.06	347.48
G 63.0	24.55	28.50	38.68	74.33	155.63	266.14	351.58
G 64.0	25.31	28.80	37.68	69.83	147.44	263.98	355.14
G 65.0	26.16	29.20	37.13	65.58	139.80	260.47	357.49
G 66.0	27.17	30.00	36.63	61.88	131.57	255.50	357.49
G 67.0	28.37	30.80	36.49	58.28	123.58	248.34	355.44
G 68.0	29.53	32.00	36.64	54.98	115.45	239.17	351.74
G 69.0	30.63	33.35	36.99	51.88	107.31	227.85	345.94
G 70.0	31.23	34.55	37.59	49.23	99.82	215.77	339.38
G 71.0	31.48	35.79	38.34	46.58	90.27	202.34	328.32
G 72.0	31.28	36.74	39.29	44.53	81.03	185.41	307.40

Apparecchio		Rilievo		Lampada	
Codice	COMPASS 1 2Z8 STU-M 3.40-2M	Codice	20-187_0920	Codice	L-COM-2Z8-3000-400-2M-70-25
Nome	COMPASS 1 2Z8 STU-M 3.40-2M	Nome	COMPASS 1 2Z8 STU-M 3.40-2M	Numero	1
Archivio	Eulumdat	Data	06-11-2020	Posizione	

Flusso Apparecchio	5590.00 lm	Potenza Apparecchio	40.50 W	Efficacia	138.02 lm/W	Rendimento	100.00%
Flusso Lampade	5590.00 lm	Valore Massimo	532.68 cd/klm	Posizione	C=15.00 G=66.00	CG	Asimmetrico

Tabella Intensità Luminosa - cd/klm Tabella 12/18

	C 325.00	C 330.00	C 335.00	C 340.00	C 345.00	C 350.00	C 355.00
G 73.0	30.52	37.19	40.29	42.84	71.48	169.83	285.73
G 74.0	29.27	37.04	40.99	41.99	63.85	153.91	264.61
G 75.0	27.61	36.34	41.44	41.89	57.42	138.07	240.33
G 76.0	25.45	34.79	41.14	41.99	51.00	117.78	208.24
G 77.0	22.64	32.39	39.89	41.89	45.43	97.13	171.90
G 78.0	19.22	29.00	37.59	41.14	40.61	76.54	133.15
G 79.0	15.96	25.01	34.24	39.19	36.74	58.61	99.71
G 80.0	12.50	20.31	29.24	35.44	32.87	43.49	72.68
G 81.0	9.08	15.52	23.24	30.18	28.35	32.27	52.35
G 82.0	6.32	10.98	16.90	23.38	23.27	24.05	36.59
G 83.0	4.02	7.24	11.10	16.52	17.85	17.89	24.48
G 84.0	2.31	4.24	6.30	10.11	11.76	12.53	15.77
G 85.0	1.31	2.15	3.00	5.41	6.43	8.22	10.01
G 86.0	0.70	1.10	1.30	2.30	2.81	4.51	6.01
G 87.0	0.35	0.50	0.60	1.00	1.01	1.95	2.75
G 88.0	0.20	0.20	0.20	0.35	0.50	0.85	1.20
G 89.0	0.00	0.00	0.10	0.10	0.20	0.35	0.60
G 90.0	0.00	0.00	0.00	0.00	0.00	0.00	0.00
G 91.0	0.00	0.00	0.00	0.00	0.00	0.00	0.00
G 92.0	0.00	0.00	0.00	0.00	0.00	0.00	0.00
G 93.0	0.00	0.00	0.00	0.00	0.00	0.00	0.00
G 94.0	0.00	0.00	0.00	0.00	0.00	0.00	0.00
G 95.0	0.00	0.00	0.00	0.00	0.00	0.00	0.00
G 96.0	0.00	0.00	0.00	0.00	0.00	0.00	0.00
G 97.0	0.00	0.00	0.00	0.00	0.00	0.00	0.00
G 98.0	0.00	0.00	0.00	0.00	0.00	0.00	0.00
G 99.0	0.00	0.00	0.00	0.00	0.00	0.00	0.00
G100.0	0.00	0.00	0.00	0.00	0.00	0.00	0.00
G101.0	0.00	0.00	0.00	0.00	0.00	0.00	0.00
G102.0	0.00	0.00	0.00	0.00	0.00	0.00	0.00
G103.0	0.00	0.00	0.00	0.00	0.00	0.00	0.00
G104.0	0.00	0.00	0.00	0.00	0.00	0.00	0.00
G105.0	0.00	0.00	0.00	0.00	0.00	0.00	0.00
G106.0	0.00	0.00	0.00	0.00	0.00	0.00	0.00
G107.0	0.00	0.00	0.00	0.00	0.00	0.00	0.00
G108.0	0.00	0.00	0.00	0.00	0.00	0.00	0.00
G109.0	0.00	0.00	0.00	0.00	0.00	0.00	0.00
G110.0	0.00	0.00	0.00	0.00	0.00	0.00	0.00
G111.0	0.00	0.00	0.00	0.00	0.00	0.00	0.00
G112.0	0.00	0.00	0.00	0.00	0.00	0.00	0.00
G113.0	0.00	0.00	0.00	0.00	0.00	0.00	0.00
G114.0	0.00	0.00	0.00	0.00	0.00	0.00	0.00
G115.0	0.00	0.00	0.00	0.00	0.00	0.00	0.00
G116.0	0.00	0.00	0.00	0.00	0.00	0.00	0.00
G117.0	0.00	0.00	0.00	0.00	0.00	0.00	0.00
G118.0	0.00	0.00	0.00	0.00	0.00	0.00	0.00
G119.0	0.00	0.00	0.00	0.00	0.00	0.00	0.00
G120.0	0.00	0.00	0.00	0.00	0.00	0.00	0.00
G121.0	0.00	0.00	0.00	0.00	0.00	0.00	0.00
G122.0	0.00	0.00	0.00	0.00	0.00	0.00	0.00
G123.0	0.00	0.00	0.00	0.00	0.00	0.00	0.00
G124.0	0.00	0.00	0.00	0.00	0.00	0.00	0.00
G125.0	0.00	0.00	0.00	0.00	0.00	0.00	0.00
G126.0	0.00	0.00	0.00	0.00	0.00	0.00	0.00
G127.0	0.00	0.00	0.00	0.00	0.00	0.00	0.00
G128.0	0.00	0.00	0.00	0.00	0.00	0.00	0.00
G129.0	0.00	0.00	0.00	0.00	0.00	0.00	0.00
G130.0	0.00	0.00	0.00	0.00	0.00	0.00	0.00
G131.0	0.00	0.00	0.00	0.00	0.00	0.00	0.00
G132.0	0.00	0.00	0.00	0.00	0.00	0.00	0.00
G133.0	0.00	0.00	0.00	0.00	0.00	0.00	0.00
G134.0	0.00	0.00	0.00	0.00	0.00	0.00	0.00
G135.0	0.00	0.00	0.00	0.00	0.00	0.00	0.00
G136.0	0.00	0.00	0.00	0.00	0.00	0.00	0.00
G137.0	0.00	0.00	0.00	0.00	0.00	0.00	0.00
G138.0	0.00	0.00	0.00	0.00	0.00	0.00	0.00
G139.0	0.00	0.00	0.00	0.00	0.00	0.00	0.00
G140.0	0.00	0.00	0.00	0.00	0.00	0.00	0.00
G141.0	0.00	0.00	0.00	0.00	0.00	0.00	0.00
G142.0	0.00	0.00	0.00	0.00	0.00	0.00	0.00
G143.0	0.00	0.00	0.00	0.00	0.00	0.00	0.00
G144.0	0.00	0.00	0.00	0.00	0.00	0.00	0.00
G145.0	0.00	0.00	0.00	0.00	0.00	0.00	0.00

Apparecchio		Rilievo		Lampada	
Codice	COMPASS 1 2Z8 STU-M 3.40-2M	Codice	20-187_0920	Codice	L-COM-2Z8-3000-400-2M-70-25
Nome	COMPASS 1 2Z8 STU-M 3.40-2M	Nome	COMPASS 1 2Z8 STU-M 3.40-2M	Numero	1
Archivio	Eulumdat	Data	06-11-2020	Posizione	

Flusso Apparecchio	5590.00 lm	Potenza Apparecchio	40.50 W	Efficacia	138.02 lm/W	Rendimento	100.00%
Flusso Lampade	5590.00 lm	Valore Massimo	532.68 cd/klm	Posizione	C=15.00 G=66.00	CG	Asimmetrico

Tabella Intensità Luminosa - cd/klm Tabella 13/18

	C 0.00	C 5.00	C 10.00	C 15.00	C 20.00	C 25.00	C 30.00	C 35.00	C 40.00	C 45.00	C 50.00	C 55.00	C 60.00
G146.0	0.00	0.00	0.00	0.00	0.00	0.00	0.00	0.00	0.00	0.00	0.00	0.00	0.00
G147.0	0.00	0.00	0.00	0.00	0.00	0.00	0.00	0.00	0.00	0.00	0.00	0.00	0.00
G148.0	0.00	0.00	0.00	0.00	0.00	0.00	0.00	0.00	0.00	0.00	0.00	0.00	0.00
G149.0	0.00	0.00	0.00	0.00	0.00	0.00	0.00	0.00	0.00	0.00	0.00	0.00	0.00
G150.0	0.00	0.00	0.00	0.00	0.00	0.00	0.00	0.00	0.00	0.00	0.00	0.00	0.00
G151.0	0.00	0.00	0.00	0.00	0.00	0.00	0.00	0.00	0.00	0.00	0.00	0.00	0.00
G152.0	0.00	0.00	0.00	0.00	0.00	0.00	0.00	0.00	0.00	0.00	0.00	0.00	0.00
G153.0	0.00	0.00	0.00	0.00	0.00	0.00	0.00	0.00	0.00	0.00	0.00	0.00	0.00
G154.0	0.00	0.00	0.00	0.00	0.00	0.00	0.00	0.00	0.00	0.00	0.00	0.00	0.00
G155.0	0.00	0.00	0.00	0.00	0.00	0.00	0.00	0.00	0.00	0.00	0.00	0.00	0.00
G156.0	0.00	0.00	0.00	0.00	0.00	0.00	0.00	0.00	0.00	0.00	0.00	0.00	0.00
G157.0	0.00	0.00	0.00	0.00	0.00	0.00	0.00	0.00	0.00	0.00	0.00	0.00	0.00
G158.0	0.00	0.00	0.00	0.00	0.00	0.00	0.00	0.00	0.00	0.00	0.00	0.00	0.00
G159.0	0.00	0.00	0.00	0.00	0.00	0.00	0.00	0.00	0.00	0.00	0.00	0.00	0.00
G160.0	0.00	0.00	0.00	0.00	0.00	0.00	0.00	0.00	0.00	0.00	0.00	0.00	0.00
G161.0	0.00	0.00	0.00	0.00	0.00	0.00	0.00	0.00	0.00	0.00	0.00	0.00	0.00
G162.0	0.00	0.00	0.00	0.00	0.00	0.00	0.00	0.00	0.00	0.00	0.00	0.00	0.00
G163.0	0.00	0.00	0.00	0.00	0.00	0.00	0.00	0.00	0.00	0.00	0.00	0.00	0.00
G164.0	0.00	0.00	0.00	0.00	0.00	0.00	0.00	0.00	0.00	0.00	0.00	0.00	0.00
G165.0	0.00	0.00	0.00	0.00	0.00	0.00	0.00	0.00	0.00	0.00	0.00	0.00	0.00
G166.0	0.00	0.00	0.00	0.00	0.00	0.00	0.00	0.00	0.00	0.00	0.00	0.00	0.00
G167.0	0.00	0.00	0.00	0.00	0.00	0.00	0.00	0.00	0.00	0.00	0.00	0.00	0.00
G168.0	0.00	0.00	0.00	0.00	0.00	0.00	0.00	0.00	0.00	0.00	0.00	0.00	0.00
G169.0	0.00	0.00	0.00	0.00	0.00	0.00	0.00	0.00	0.00	0.00	0.00	0.00	0.00
G170.0	0.00	0.00	0.00	0.00	0.00	0.00	0.00	0.00	0.00	0.00	0.00	0.00	0.00
G171.0	0.00	0.00	0.00	0.00	0.00	0.00	0.00	0.00	0.00	0.00	0.00	0.00	0.00
G172.0	0.00	0.00	0.00	0.00	0.00	0.00	0.00	0.00	0.00	0.00	0.00	0.00	0.00
G173.0	0.00	0.00	0.00	0.00	0.00	0.00	0.00	0.00	0.00	0.00	0.00	0.00	0.00
G174.0	0.00	0.00	0.00	0.00	0.00	0.00	0.00	0.00	0.00	0.00	0.00	0.00	0.00
G175.0	0.00	0.00	0.00	0.00	0.00	0.00	0.00	0.00	0.00	0.00	0.00	0.00	0.00
G176.0	0.00	0.00	0.00	0.00	0.00	0.00	0.00	0.00	0.00	0.00	0.00	0.00	0.00
G177.0	0.00	0.00	0.00	0.00	0.00	0.00	0.00	0.00	0.00	0.00	0.00	0.00	0.00
G178.0	0.00	0.00	0.00	0.00	0.00	0.00	0.00	0.00	0.00	0.00	0.00	0.00	0.00
G179.0	0.00	0.00	0.00	0.00	0.00	0.00	0.00	0.00	0.00	0.00	0.00	0.00	0.00
G180.0	0.00	0.00	0.00	0.00	0.00	0.00	0.00	0.00	0.00	0.00	0.00	0.00	0.00

Apparecchio		Rilievo		Lampada	
Codice	COMPASS 1 2Z8 STU-M 3.40-2M	Codice	20-187_0920	Codice	L-COM-2Z8-3000-400-2M-70-25
Nome	COMPASS 1 2Z8 STU-M 3.40-2M	Nome	COMPASS 1 2Z8 STU-M 3.40-2M	Numero	1
Archivio	Eulumdat	Data	06-11-2020	Posizione	

Flusso Apparecchio	5590.00 lm	Potenza Apparecchio	40.50 W	Efficacia	138.02 lm/W	Rendimento	100.00%
Flusso Lampade	5590.00 lm	Valore Massimo	532.68 cd/klm	Posizione	C=15.00 G=66.00	CG	Asimmetrico

Tabella Intensità Luminose - cd/klm Tabella 14/18

	C 65.00	C 70.00	C 75.00	C 80.00	C 85.00	C 90.00	C 95.00	C 100.00	C 105.00	C 110.00	C 115.00	C 120.00	C 125.00
G146.0	0.00	0.00	0.00	0.00	0.00	0.00	0.00	0.00	0.00	0.00	0.00	0.00	0.00
G147.0	0.00	0.00	0.00	0.00	0.00	0.00	0.00	0.00	0.00	0.00	0.00	0.00	0.00
G148.0	0.00	0.00	0.00	0.00	0.00	0.00	0.00	0.00	0.00	0.00	0.00	0.00	0.00
G149.0	0.00	0.00	0.00	0.00	0.00	0.00	0.00	0.00	0.00	0.00	0.00	0.00	0.00
G150.0	0.00	0.00	0.00	0.00	0.00	0.00	0.00	0.00	0.00	0.00	0.00	0.00	0.00
G151.0	0.00	0.00	0.00	0.00	0.00	0.00	0.00	0.00	0.00	0.00	0.00	0.00	0.00
G152.0	0.00	0.00	0.00	0.00	0.00	0.00	0.00	0.00	0.00	0.00	0.00	0.00	0.00
G153.0	0.00	0.00	0.00	0.00	0.00	0.00	0.00	0.00	0.00	0.00	0.00	0.00	0.00
G154.0	0.00	0.00	0.00	0.00	0.00	0.00	0.00	0.00	0.00	0.00	0.00	0.00	0.00
G155.0	0.00	0.00	0.00	0.00	0.00	0.00	0.00	0.00	0.00	0.00	0.00	0.00	0.00
G156.0	0.00	0.00	0.00	0.00	0.00	0.00	0.00	0.00	0.00	0.00	0.00	0.00	0.00
G157.0	0.00	0.00	0.00	0.00	0.00	0.00	0.00	0.00	0.00	0.00	0.00	0.00	0.00
G158.0	0.00	0.00	0.00	0.00	0.00	0.00	0.00	0.00	0.00	0.00	0.00	0.00	0.00
G159.0	0.00	0.00	0.00	0.00	0.00	0.00	0.00	0.00	0.00	0.00	0.00	0.00	0.00
G160.0	0.00	0.00	0.00	0.00	0.00	0.00	0.00	0.00	0.00	0.00	0.00	0.00	0.00
G161.0	0.00	0.00	0.00	0.00	0.00	0.00	0.00	0.00	0.00	0.00	0.00	0.00	0.00
G162.0	0.00	0.00	0.00	0.00	0.00	0.00	0.00	0.00	0.00	0.00	0.00	0.00	0.00
G163.0	0.00	0.00	0.00	0.00	0.00	0.00	0.00	0.00	0.00	0.00	0.00	0.00	0.00
G164.0	0.00	0.00	0.00	0.00	0.00	0.00	0.00	0.00	0.00	0.00	0.00	0.00	0.00
G165.0	0.00	0.00	0.00	0.00	0.00	0.00	0.00	0.00	0.00	0.00	0.00	0.00	0.00
G166.0	0.00	0.00	0.00	0.00	0.00	0.00	0.00	0.00	0.00	0.00	0.00	0.00	0.00
G167.0	0.00	0.00	0.00	0.00	0.00	0.00	0.00	0.00	0.00	0.00	0.00	0.00	0.00
G168.0	0.00	0.00	0.00	0.00	0.00	0.00	0.00	0.00	0.00	0.00	0.00	0.00	0.00
G169.0	0.00	0.00	0.00	0.00	0.00	0.00	0.00	0.00	0.00	0.00	0.00	0.00	0.00
G170.0	0.00	0.00	0.00	0.00	0.00	0.00	0.00	0.00	0.00	0.00	0.00	0.00	0.00
G171.0	0.00	0.00	0.00	0.00	0.00	0.00	0.00	0.00	0.00	0.00	0.00	0.00	0.00
G172.0	0.00	0.00	0.00	0.00	0.00	0.00	0.00	0.00	0.00	0.00	0.00	0.00	0.00
G173.0	0.00	0.00	0.00	0.00	0.00	0.00	0.00	0.00	0.00	0.00	0.00	0.00	0.00
G174.0	0.00	0.00	0.00	0.00	0.00	0.00	0.00	0.00	0.00	0.00	0.00	0.00	0.00
G175.0	0.00	0.00	0.00	0.00	0.00	0.00	0.00	0.00	0.00	0.00	0.00	0.00	0.00
G176.0	0.00	0.00	0.00	0.00	0.00	0.00	0.00	0.00	0.00	0.00	0.00	0.00	0.00
G177.0	0.00	0.00	0.00	0.00	0.00	0.00	0.00	0.00	0.00	0.00	0.00	0.00	0.00
G178.0	0.00	0.00	0.00	0.00	0.00	0.00	0.00	0.00	0.00	0.00	0.00	0.00	0.00
G179.0	0.00	0.00	0.00	0.00	0.00	0.00	0.00	0.00	0.00	0.00	0.00	0.00	0.00
G180.0	0.00	0.00	0.00	0.00	0.00	0.00	0.00	0.00	0.00	0.00	0.00	0.00	0.00

Apparecchio			Rilievo			Lampada			
Codice	COMPASS 1 2Z8 STU-M 3.40-2M		Codice	20-187_0920		Codice	L-COM-2Z8-3000-400-2M-70-25		
Nome	COMPASS 1 2Z8 STU-M 3.40-2M		Nome	COMPASS 1 2Z8 STU-M 3.40-2M		Numero	1		
Archivio	Eulumdat		Data	06-11-2020		Posizione			

Flusso Apparecchio	5590.00 lm	Potenza Apparecchio	40.50 W	Efficacia	138.02 lm/W	Rendimento	100.00%
Flusso Lampade	5590.00 lm	Valore Massimo	532.68 cd/klm	Posizione	C=15.00 G=66.00	CG	Asimmetrico

Tabella Intensità Luminose - cd/klm Tabella 15/18

	C 130.00	C 135.00	C 140.00	C 145.00	C 150.00	C 155.00	C 160.00	C 165.00	C 170.00	C 175.00	C 180.00	C 185.00	C 190.00
G146.0	0.00	0.00	0.00	0.00	0.00	0.00	0.00	0.00	0.00	0.00	0.00	0.00	0.00
G147.0	0.00	0.00	0.00	0.00	0.00	0.00	0.00	0.00	0.00	0.00	0.00	0.00	0.00
G148.0	0.00	0.00	0.00	0.00	0.00	0.00	0.00	0.00	0.00	0.00	0.00	0.00	0.00
G149.0	0.00	0.00	0.00	0.00	0.00	0.00	0.00	0.00	0.00	0.00	0.00	0.00	0.00
G150.0	0.00	0.00	0.00	0.00	0.00	0.00	0.00	0.00	0.00	0.00	0.00	0.00	0.00
G151.0	0.00	0.00	0.00	0.00	0.00	0.00	0.00	0.00	0.00	0.00	0.00	0.00	0.00
G152.0	0.00	0.00	0.00	0.00	0.00	0.00	0.00	0.00	0.00	0.00	0.00	0.00	0.00
G153.0	0.00	0.00	0.00	0.00	0.00	0.00	0.00	0.00	0.00	0.00	0.00	0.00	0.00
G154.0	0.00	0.00	0.00	0.00	0.00	0.00	0.00	0.00	0.00	0.00	0.00	0.00	0.00
G155.0	0.00	0.00	0.00	0.00	0.00	0.00	0.00	0.00	0.00	0.00	0.00	0.00	0.00
G156.0	0.00	0.00	0.00	0.00	0.00	0.00	0.00	0.00	0.00	0.00	0.00	0.00	0.00
G157.0	0.00	0.00	0.00	0.00	0.00	0.00	0.00	0.00	0.00	0.00	0.00	0.00	0.00
G158.0	0.00	0.00	0.00	0.00	0.00	0.00	0.00	0.00	0.00	0.00	0.00	0.00	0.00
G159.0	0.00	0.00	0.00	0.00	0.00	0.00	0.00	0.00	0.00	0.00	0.00	0.00	0.00
G160.0	0.00	0.00	0.00	0.00	0.00	0.00	0.00	0.00	0.00	0.00	0.00	0.00	0.00
G161.0	0.00	0.00	0.00	0.00	0.00	0.00	0.00	0.00	0.00	0.00	0.00	0.00	0.00
G162.0	0.00	0.00	0.00	0.00	0.00	0.00	0.00	0.00	0.00	0.00	0.00	0.00	0.00
G163.0	0.00	0.00	0.00	0.00	0.00	0.00	0.00	0.00	0.00	0.00	0.00	0.00	0.00
G164.0	0.00	0.00	0.00	0.00	0.00	0.00	0.00	0.00	0.00	0.00	0.00	0.00	0.00
G165.0	0.00	0.00	0.00	0.00	0.00	0.00	0.00	0.00	0.00	0.00	0.00	0.00	0.00
G166.0	0.00	0.00	0.00	0.00	0.00	0.00	0.00	0.00	0.00	0.00	0.00	0.00	0.00
G167.0	0.00	0.00	0.00	0.00	0.00	0.00	0.00	0.00	0.00	0.00	0.00	0.00	0.00
G168.0	0.00	0.00	0.00	0.00	0.00	0.00	0.00	0.00	0.00	0.00	0.00	0.00	0.00
G169.0	0.00	0.00	0.00	0.00	0.00	0.00	0.00	0.00	0.00	0.00	0.00	0.00	0.00
G170.0	0.00	0.00	0.00	0.00	0.00	0.00	0.00	0.00	0.00	0.00	0.00	0.00	0.00
G171.0	0.00	0.00	0.00	0.00	0.00	0.00	0.00	0.00	0.00	0.00	0.00	0.00	0.00
G172.0	0.00	0.00	0.00	0.00	0.00	0.00	0.00	0.00	0.00	0.00	0.00	0.00	0.00
G173.0	0.00	0.00	0.00	0.00	0.00	0.00	0.00	0.00	0.00	0.00	0.00	0.00	0.00
G174.0	0.00	0.00	0.00	0.00	0.00	0.00	0.00	0.00	0.00	0.00	0.00	0.00	0.00
G175.0	0.00	0.00	0.00	0.00	0.00	0.00	0.00	0.00	0.00	0.00	0.00	0.00	0.00
G176.0	0.00	0.00	0.00	0.00	0.00	0.00	0.00	0.00	0.00	0.00	0.00	0.00	0.00
G177.0	0.00	0.00	0.00	0.00	0.00	0.00	0.00	0.00	0.00	0.00	0.00	0.00	0.00
G178.0	0.00	0.00	0.00	0.00	0.00	0.00	0.00	0.00	0.00	0.00	0.00	0.00	0.00
G179.0	0.00	0.00	0.00	0.00	0.00	0.00	0.00	0.00	0.00	0.00	0.00	0.00	0.00
G180.0	0.00	0.00	0.00	0.00	0.00	0.00	0.00	0.00	0.00	0.00	0.00	0.00	0.00

Apparecchio			Rilievo			Lampada			
Codice	COMPASS 1 2Z8 STU-M 3.40-2M		Codice	20-187_0920		Codice	L-COM-2Z8-3000-400-2M-70-25		
Nome	COMPASS 1 2Z8 STU-M 3.40-2M		Nome	COMPASS 1 2Z8 STU-M 3.40-2M		Numero	1		
Archivio	Eulumdat		Data	06-11-2020		Posizione			

Flusso Apparecchio	5590.00 lm	Potenza Apparecchio	40.50 W	Efficacia	138.02 lm/W	Rendimento	100.00%
Flusso Lampade	5590.00 lm	Valore Massimo	532.68 cd/klm	Posizione	C=15.00 G=66.00	CG	Asimmetrico

Tabella Intensità Luminose - cd/klm Tabella 16/18

	C 195.00	C 200.00	C 205.00	C 210.00	C 215.00	C 220.00	C 225.00	C 230.00	C 235.00	C 240.00	C 245.00	C 250.00	C 255.00
G146.0	0.00	0.00	0.00	0.00	0.00	0.00	0.00	0.00	0.00	0.00	0.00	0.00	0.00
G147.0	0.00	0.00	0.00	0.00	0.00	0.00	0.00	0.00	0.00	0.00	0.00	0.00	0.00
G148.0	0.00	0.00	0.00	0.00	0.00	0.00	0.00	0.00	0.00	0.00	0.00	0.00	0.00
G149.0	0.00	0.00	0.00	0.00	0.00	0.00	0.00	0.00	0.00	0.00	0.00	0.00	0.00
G150.0	0.00	0.00	0.00	0.00	0.00	0.00	0.00	0.00	0.00	0.00	0.00	0.00	0.00
G151.0	0.00	0.00	0.00	0.00	0.00	0.00	0.00	0.00	0.00	0.00	0.00	0.00	0.00
G152.0	0.00	0.00	0.00	0.00	0.00	0.00	0.00	0.00	0.00	0.00	0.00	0.00	0.00
G153.0	0.00	0.00	0.00	0.00	0.00	0.00	0.00	0.00	0.00	0.00	0.00	0.00	0.00
G154.0	0.00	0.00	0.00	0.00	0.00	0.00	0.00	0.00	0.00	0.00	0.00	0.00	0.00
G155.0	0.00	0.00	0.00	0.00	0.00	0.00	0.00	0.00	0.00	0.00	0.00	0.00	0.00
G156.0	0.00	0.00	0.00	0.00	0.00	0.00	0.00	0.00	0.00	0.00	0.00	0.00	0.00
G157.0	0.00	0.00	0.00	0.00	0.00	0.00	0.00	0.00	0.00	0.00	0.00	0.00	0.00
G158.0	0.00	0.00	0.00	0.00	0.00	0.00	0.00	0.00	0.00	0.00	0.00	0.00	0.00
G159.0	0.00	0.00	0.00	0.00	0.00	0.00	0.00	0.00	0.00	0.00	0.00	0.00	0.00
G160.0	0.00	0.00	0.00	0.00	0.00	0.00	0.00	0.00	0.00	0.00	0.00	0.00	0.00
G161.0	0.00	0.00	0.00	0.00	0.00	0.00	0.00	0.00	0.00	0.00	0.00	0.00	0.00
G162.0	0.00	0.00	0.00	0.00	0.00	0.00	0.00	0.00	0.00	0.00	0.00	0.00	0.00
G163.0	0.00	0.00	0.00	0.00	0.00	0.00	0.00	0.00	0.00	0.00	0.00	0.00	0.00
G164.0	0.00	0.00	0.00	0.00	0.00	0.00	0.00	0.00	0.00	0.00	0.00	0.00	0.00
G165.0	0.00	0.00	0.00	0.00	0.00	0.00	0.00	0.00	0.00	0.00	0.00	0.00	0.00
G166.0	0.00	0.00	0.00	0.00	0.00	0.00	0.00	0.00	0.00	0.00	0.00	0.00	0.00
G167.0	0.00	0.00	0.00	0.00	0.00	0.00	0.00	0.00	0.00	0.00	0.00	0.00	0.00
G168.0	0.00	0.00	0.00	0.00	0.00	0.00	0.00	0.00	0.00	0.00	0.00	0.00	0.00
G169.0	0.00	0.00	0.00	0.00	0.00	0.00	0.00	0.00	0.00	0.00	0.00	0.00	0.00
G170.0	0.00	0.00	0.00	0.00	0.00	0.00	0.00	0.00	0.00	0.00	0.00	0.00	0.00
G171.0	0.00	0.00	0.00	0.00	0.00	0.00	0.00	0.00	0.00	0.00	0.00	0.00	0.00
G172.0	0.00	0.00	0.00	0.00	0.00	0.00	0.00	0.00	0.00	0.00	0.00	0.00	0.00
G173.0	0.00	0.00	0.00	0.00	0.00	0.00	0.00	0.00	0.00	0.00	0.00	0.00	0.00
G174.0	0.00	0.00	0.00	0.00	0.00	0.00	0.00	0.00	0.00	0.00	0.00	0.00	0.00
G175.0	0.00	0.00	0.00	0.00	0.00	0.00	0.00	0.00	0.00	0.00	0.00	0.00	0.00
G176.0	0.00	0.00	0.00	0.00	0.00	0.00	0.00	0.00	0.00	0.00	0.00	0.00	0.00
G177.0	0.00	0.00	0.00	0.00	0.00	0.00	0.00	0.00	0.00	0.00	0.00	0.00	0.00
G178.0	0.00	0.00	0.00	0.00	0.00	0.00	0.00	0.00	0.00	0.00	0.00	0.00	0.00
G179.0	0.00	0.00	0.00	0.00	0.00	0.00	0.00	0.00	0.00	0.00	0.00	0.00	0.00
G180.0	0.00	0.00	0.00	0.00	0.00	0.00	0.00	0.00	0.00	0.00	0.00	0.00	0.00

Apparecchio			Rilievo			Lampada			
Codice	COMPASS 1 2Z8 STU-M 3.40-2M		Codice	20-187_0920		Codice	L-COM-2Z8-3000-400-2M-70-25		
Nome	COMPASS 1 2Z8 STU-M 3.40-2M		Nome	COMPASS 1 2Z8 STU-M 3.40-2M		Numero	1		
Archivio	Eulumdat		Data	06-11-2020		Posizione			

Flusso Apparecchio	5590.00 lm	Potenza Apparecchio	40.50 W	Efficacia	138.02 lm/W	Rendimento	100.00%
Flusso Lampade	5590.00 lm	Valore Massimo	532.68 cd/klm	Posizione	C=15.00 G=66.00	CG	Asimmetrico

Tabella Intensità Luminose - cd/klm Tabella 17/18

	C 260.00	C 265.00	C 270.00	C 275.00	C 280.00	C 285.00	C 290.00	C 295.00	C 300.00	C 305.00	C 310.00	C 315.00	C 320.00
G146.0	0.00	0.00	0.00	0.00	0.00	0.00	0.00	0.00	0.00	0.00	0.00	0.00	0.00
G147.0	0.00	0.00	0.00	0.00	0.00	0.00	0.00	0.00	0.00	0.00	0.00	0.00	0.00
G148.0	0.00	0.00	0.00	0.00	0.00	0.00	0.00	0.00	0.00	0.00	0.00	0.00	0.00
G149.0	0.00	0.00	0.00	0.00	0.00	0.00	0.00	0.00	0.00	0.00	0.00	0.00	0.00
G150.0	0.00	0.00	0.00	0.00	0.00	0.00	0.00	0.00	0.00	0.00	0.00	0.00	0.00
G151.0	0.00	0.00	0.00	0.00	0.00	0.00	0.00	0.00	0.00	0.00	0.00	0.00	0.00
G152.0	0.00	0.00	0.00	0.00	0.00	0.00	0.00	0.00	0.00	0.00	0.00	0.00	0.00
G153.0	0.00	0.00	0.00	0.00	0.00	0.00	0.00	0.00	0.00	0.00	0.00	0.00	0.00
G154.0	0.00	0.00	0.00	0.00	0.00	0.00	0.00	0.00	0.00	0.00	0.00	0.00	0.00
G155.0	0.00	0.00	0.00	0.00	0.00	0.00	0.00	0.00	0.00	0.00	0.00	0.00	0.00
G156.0	0.00	0.00	0.00	0.00	0.00	0.00	0.00	0.00	0.00	0.00	0.00	0.00	0.00
G157.0	0.00	0.00	0.00	0.00	0.00	0.00	0.00	0.00	0.00	0.00	0.00	0.00	0.00
G158.0	0.00	0.00	0.00	0.00	0.00	0.00	0.00	0.00	0.00	0.00	0.00	0.00	0.00
G159.0	0.00	0.00	0.00	0.00	0.00	0.00	0.00	0.00	0.00	0.00	0.00	0.00	0.00
G160.0	0.00	0.00	0.00	0.00	0.00	0.00	0.00	0.00	0.00	0.00	0.00	0.00	0.00
G161.0	0.00	0.00	0.00	0.00	0.00	0.00	0.00	0.00	0.00	0.00	0.00	0.00	0.00
G162.0	0.00	0.00	0.00	0.00	0.00	0.00	0.00	0.00	0.00	0.00	0.00	0.00	0.00
G163.0	0.00	0.00	0.00	0.00	0.00	0.00	0.00	0.00	0.00	0.00	0.00	0.00	0.00
G164.0	0.00	0.00	0.00	0.00	0.00	0.00	0.00	0.00	0.00	0.00	0.00	0.00	0.00
G165.0	0.00	0.00	0.00	0.00	0.00	0.00	0.00	0.00	0.00	0.00	0.00	0.00	0.00
G166.0	0.00	0.00	0.00	0.00	0.00	0.00	0.00	0.00	0.00	0.00	0.00	0.00	0.00
G167.0	0.00	0.00	0.00	0.00	0.00	0.00	0.00	0.00	0.00	0.00	0.00	0.00	0.00
G168.0	0.00	0.00	0.00	0.00	0.00	0.00	0.00	0.00	0.00	0.00	0.00	0.00	0.00
G169.0	0.00	0.00	0.00	0.00	0.00	0.00	0.00	0.00	0.00	0.00	0.00	0.00	0.00
G170.0	0.00	0.00	0.00	0.00	0.00	0.00	0.00	0.00	0.00	0.00	0.00	0.00	0.00
G171.0	0.00	0.00	0.00	0.00	0.00	0.00	0.00	0.00	0.00	0.00	0.00	0.00	0.00
G172.0	0.00	0.00	0.00	0.00	0.00	0.00	0.00	0.00	0.00	0.00	0.00	0.00	0.00
G173.0	0.00	0.00	0.00	0.00	0.00	0.00	0.00	0.00	0.00	0.00	0.00	0.00	0.00
G174.0	0.00	0.00	0.00	0.00	0.00	0.00	0.00	0.00	0.00	0.00	0.00	0.00	0.00
G175.0	0.00	0.00	0.00	0.00	0.00	0.00	0.00	0.00	0.00	0.00	0.00	0.00	0.00
G176.0	0.00	0.00	0.00	0.00	0.00	0.00	0.00	0.00	0.00	0.00	0.00	0.00	0.00
G177.0	0.00	0.00	0.00	0.00	0.00	0.00	0.00	0.00	0.00	0.00	0.00	0.00	0.00
G178.0	0.00	0.00	0.00	0.00	0.00	0.00	0.00	0.00	0.00	0.00	0.00	0.00	0.00
G179.0	0.00	0.00	0.00	0.00	0.00	0.00	0.00	0.00	0.00	0.00	0.00	0.00	0.00
G180.0	0.00	0.00	0.00	0.00	0.00	0.00	0.00	0.00	0.00	0.00	0.00	0.00	0.00

Apparecchio		Rilievo		Lampada	
Codice	COMPASS 1 2Z8 STU-M 3.40-2M	Codice	20-187_0920	Codice	L-COM-2Z8-3000-400-2M-70-25
Nome	COMPASS 1 2Z8 STU-M 3.40-2M	Nome	COMPASS 1 2Z8 STU-M 3.40-2M	Numero	1
Archivio	Eulumdat	Data	06-11-2020	Posizione	

Flusso Apparecchio	5590.00 lm	Potenza Apparecchio	40.50 W	Efficacia	138.02 lm/W	Rendimento	100.00%
Flusso Lampade	5590.00 lm	Valore Massimo	532.68 cd/klm	Posizione	C=15.00 G=66.00	CG	Asimmetrico

Tabella Intensità Luminose - cd/klm Tabella 18/18

	C 325.00	C 330.00	C 335.00	C 340.00	C 345.00	C 350.00	C 355.00
G146.0	0.00	0.00	0.00	0.00	0.00	0.00	0.00
G147.0	0.00	0.00	0.00	0.00	0.00	0.00	0.00
G148.0	0.00	0.00	0.00	0.00	0.00	0.00	0.00
G149.0	0.00	0.00	0.00	0.00	0.00	0.00	0.00
G150.0	0.00	0.00	0.00	0.00	0.00	0.00	0.00
G151.0	0.00	0.00	0.00	0.00	0.00	0.00	0.00
G152.0	0.00	0.00	0.00	0.00	0.00	0.00	0.00
G153.0	0.00	0.00	0.00	0.00	0.00	0.00	0.00
G154.0	0.00	0.00	0.00	0.00	0.00	0.00	0.00
G155.0	0.00	0.00	0.00	0.00	0.00	0.00	0.00
G156.0	0.00	0.00	0.00	0.00	0.00	0.00	0.00
G157.0	0.00	0.00	0.00	0.00	0.00	0.00	0.00
G158.0	0.00	0.00	0.00	0.00	0.00	0.00	0.00
G159.0	0.00	0.00	0.00	0.00	0.00	0.00	0.00
G160.0	0.00	0.00	0.00	0.00	0.00	0.00	0.00
G161.0	0.00	0.00	0.00	0.00	0.00	0.00	0.00
G162.0	0.00	0.00	0.00	0.00	0.00	0.00	0.00
G163.0	0.00	0.00	0.00	0.00	0.00	0.00	0.00
G164.0	0.00	0.00	0.00	0.00	0.00	0.00	0.00
G165.0	0.00	0.00	0.00	0.00	0.00	0.00	0.00
G166.0	0.00	0.00	0.00	0.00	0.00	0.00	0.00
G167.0	0.00	0.00	0.00	0.00	0.00	0.00	0.00
G168.0	0.00	0.00	0.00	0.00	0.00	0.00	0.00
G169.0	0.00	0.00	0.00	0.00	0.00	0.00	0.00
G170.0	0.00	0.00	0.00	0.00	0.00	0.00	0.00
G171.0	0.00	0.00	0.00	0.00	0.00	0.00	0.00
G172.0	0.00	0.00	0.00	0.00	0.00	0.00	0.00
G173.0	0.00	0.00	0.00	0.00	0.00	0.00	0.00
G174.0	0.00	0.00	0.00	0.00	0.00	0.00	0.00
G175.0	0.00	0.00	0.00	0.00	0.00	0.00	0.00
G176.0	0.00	0.00	0.00	0.00	0.00	0.00	0.00
G177.0	0.00	0.00	0.00	0.00	0.00	0.00	0.00
G178.0	0.00	0.00	0.00	0.00	0.00	0.00	0.00
G179.0	0.00	0.00	0.00	0.00	0.00	0.00	0.00
G180.0	0.00	0.00	0.00	0.00	0.00	0.00	0.00

Apparecchio		Rilievo		Lampada			
Codice	COMPASS 1 2Z8 STU-M 3.40-2M	Codice	20-187_0920	Codice	L-COM-2Z8-3000-400-2M-70-25		
Nome	COMPASS 1 2Z8 STU-M 3.40-2M	Nome	COMPASS 1 2Z8 STU-M 3.40-2M	Numero	1		
Archivio	Eulumdat	Data	06-11-2020	Posizione			
Flusso Apparecchio	5590.00 lm	Potenza Apparecchio	40.50 W	Efficacia	138.02 lm/W	Rendimento	100.00%
Flusso Lampade	5590.00 lm	Valore Massimo	532.68 cd/klm	Posizione	C=15.00 G=66.00	CG	Asimmetrico
Apparecchio Circolare	Diam.	540 mm	Alt.	85 mm	Alt.		0 mm
Area Luminosa Rettangolare	Lung.	95 mm	Larg.	225 mm			
Area Luminosa Orizzontale		0.021375 m2	Area Luminosa Piano 180°		0.000000 m2		
Area Luminosa Piano 0°		0.000000 m2	Area Luminosa Piano 270°		0.000000 m2		
Area Luminosa Piano 90°		0.000000 m2	Area Luminosa a 76°		0.005171 m2		
Sistema Coordinate	CG	Tipo di Simmetria		Asimmetrico			
Data	06-11-2020	Massimo Angolo Gamma		180			
Lampade Apparecchio							
Archivio	Codice	Nome	Flusso [lm]	Pot. [W]	Q.tà		
	L-COM-2Z8-3000-400-2M-70-25	L-COM-2Z8-3000-400-2M-70-25 - 40.50 W	5590.00	40.50	1		
C.I.E.	43 75 96 100 100	D DIN 5040	A30				
F UTE	1.00 E	B NBN	BZ 5				

Diam=540mm

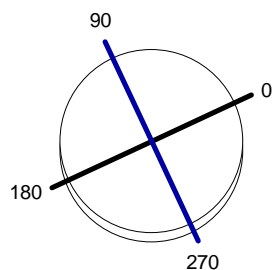

Semipiani C



ULOR 0.00 %
DLOR 100.00 %
RN 0.00 %

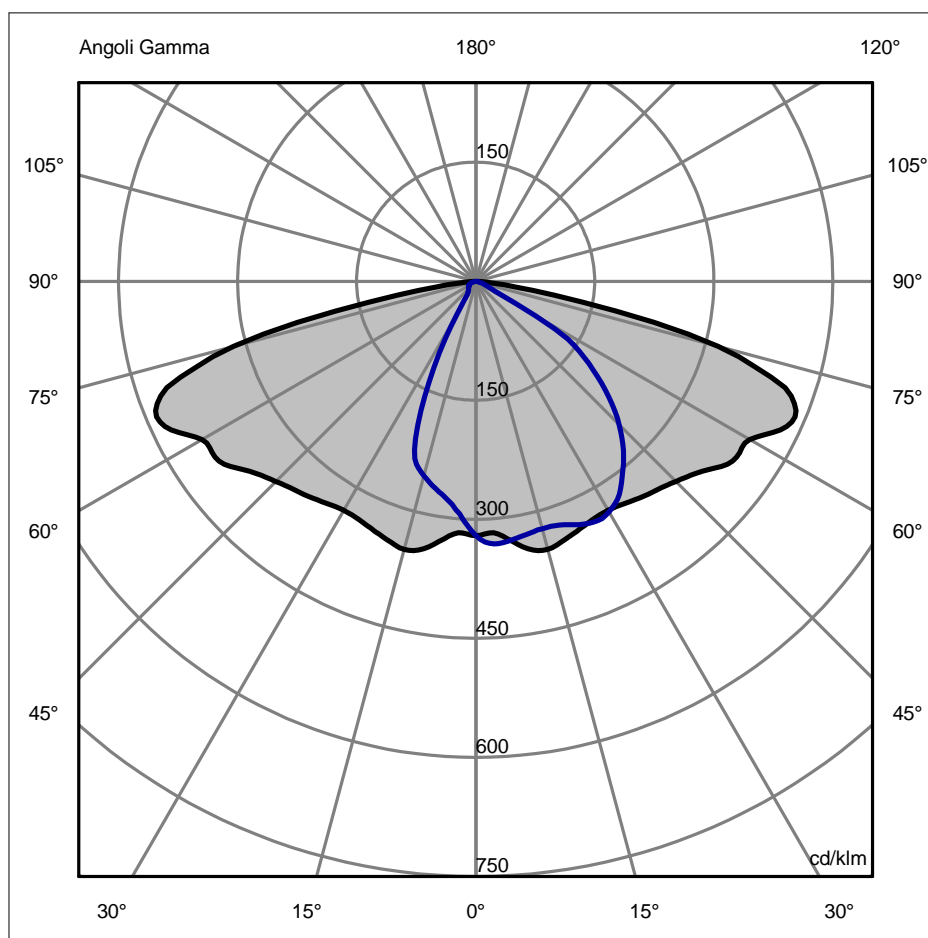

Apparecchio		Rilievo		Lampada		
Codice	COMPASS 1 2Z8 STU-M 3.40-2M	Codice	20-187_0920	Codice	L-COM-2Z8-3000-400-2M-70-25	
Nome	COMPASS 1 2Z8 STU-M 3.40-2M	Nome	COMPASS 1 2Z8 STU-M 3.40-2M	Numero	1	
Archivio	Eulumdat	Data	06-11-2020	Posizione		

Flusso Apparecchio	5590.00 lm	Potenza Apparecchio	40.50 W	Efficacia	138.02 lm/W	Rendimento	100.00%
Flusso Lampade	5590.00 lm	Valore Massimo	532.68 cd/klm	Posizione	C=15.00 G=66.00	CG	Asimmetrico

Marciapiede			Strada		
Piano	0	0.00%	Piano	0	0.00%
Piano	-5	5.75%	Piano	5	6.17%
Piano	-10	10.99%	Piano	10	12.47%
Piano	-15	15.83%	Piano	15	18.81%
Piano	-20	20.21%	Piano	20	25.26%
Piano	-25	23.59%	Piano	25	31.91%
Piano	-30	25.51%	Piano	30	38.66%
Piano	-35	26.36%	Piano	35	45.25%
Piano	-40	26.90%	Piano	40	51.41%
Piano	-45	27.32%	Piano	45	56.99%
Piano	-50	27.68%	Piano	50	61.83%
Piano	-55	28.02%	Piano	55	65.77%
Piano	-60	28.36%	Piano	60	68.67%
Piano	-65	28.67%	Piano	65	69.94%
Piano	-70	28.91%	Piano	70	70.51%
Piano	-75	29.06%	Piano	75	70.73%
Piano	-80	29.12%	Piano	80	70.83%
Piano	-85	29.13%	Piano	85	70.86%
Piano	-90	29.13%	Piano	90	70.87%

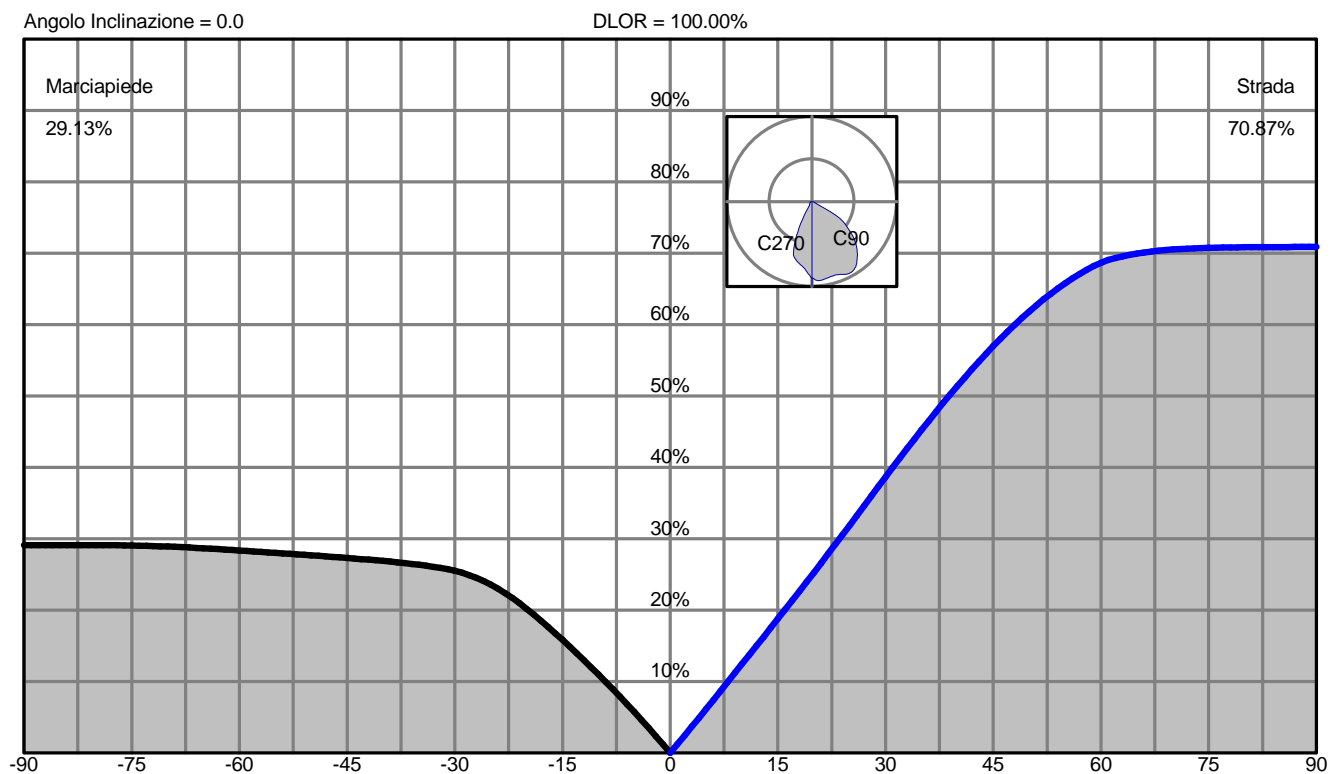

Spread	40.9° Stretto	DLOR	100.00000 %
Throw	64.9° Intermedio	ULOR	0.00000 %
SLI	3.4 Medio	Rendimento	100.00000 %
Cutoff CIE	Non Cutoff - Max: C=15.0° Gamma=66.0°	RN	0.00000 %
Cutoff Iesna	Semi Cutoff	Classe Intensità Luminosa	G2
DIN5044	--	Indice Abbagliamento	D3
IESNA Type II Short Asymmetrical			

Photometric Test Report



Costruttore	AEC ILLUMINAZIONE SRL
Tipo di prodotto	Outdoor Lighting Luminaire
Codice fotometria	COMPASS 1 2Z8 STU-W 3.50-2M
Codice apparecchio	COMPASS 1 2Z8 STU-W 3.50-2M
Rilievo fotometrico	20-204_1120
Descrizione apparecchio	COMPASS 1 2Z8 STU-W 3.50-2M
Data emissione	06-11-2020

Foto del prodotto



Responsabile laboratorio fotometrico	Luca Vagheggi	
Tecnico laboratorio che ha eseguito la misura	Alessio Vagheggi	



Sommario e Allegati

Sommario	Dati apparecchio	
	Normative di riferimento	
	Procedure di riferimento	
	Condizioni di prova	
	Risultati fotometrici	
	Lista strumentazione	
	Incertezza strumentale	
Allegati	Dati Generali	X
	Tabella fotometrica delle Intensità (cd/Klm)	X
	Tabella fotometrica delle Intensità (cd)	
	Diagramma Polare	
	Diagramma Cartesiano	
	Valutazione UGR	
	Diagramma Sollner Abbagliamento	
	Flusso Zonale	
	Coefficienti di Utilizzazione	
	Isolux Unitario	
	Isocandele Percentuale	
	Tabella e Diagramma Luminanza	
	Classificazione Strade	X
Classificazione Strade IES TM-15		

DATI APPARECCHIO

Geometria apparecchio	Circolare		
Dimensioni apparecchio (mm)	Lunghezza / Diametro	Larghezza	Altezza
	540	540	85
Dimensioni area luminosa (mm)	Lunghezza / Diametro	Larghezza	Altezza C0
	95	225	0
	Altezza C90	Altezza C180	Altezza C270
	0	0	0
Tipo sorgente	LED		
Modello sorgente	Luxeon 5050s		
Tipo Alimentatore	Elettronico / Electronic		
Modello Alimentatore	Philips Xi		

NORMATIVE DI RIFERIMENTO

Normative di riferimento	UNI EN 13032-1:2012 UNI EN 13032-4:2015
Valutazione luce parassita	In accordo con Annex A UNI EN 13032-1

PROCEDURE DI RIFERIMENTO

Procedure di riferimento	I-QL-009
---------------------------------	----------

CONDIZIONI DI PROVA

Laboratorio fotometrico	Interno AEC ILLUMINAZIONE srl, in regime di sistema di qualità aziendale certificato ISO 9001:2008, autorizzato UL	
Condizioni Ambientali	Temperatura ambiente (°C)	25
	Umidità relativa (°RH)	< 60
	Movimento aria (m/s)	< 0.2
Condizioni Elettriche	Tensione di alimentazione (V)	230
	Frequenza di alimentazione (Hz)	50
	Distorsione armonica THD V (%)	< 0.5%
Condizioni Preliminari Prova	Metodo di misura	Goniofotometro
	Sistema di riferimento misura	Sistema C-γ (Gonio)
	Posizione di misura	Verticale (Gonio)
	Distanza di misura (m)	9.03
	Tempo di stabilizzazione (min)	> 60
	Instabilità sorgente (%)	< 0.5%

I risultati delle verifiche e prove qui riportati, si riferiscono esclusivamente agli esemplari esaminati e descritti nella presente Relazione. L'estensione del riferimento ad esemplari che non siano quelli sottoposti alle verifiche descritte in seguito esula dallo scopo delle verifiche stesse. E' vietata la riproduzione integrale o parziale senza l'autorizzazione scritta di Aec illuminazione srl. L'immagine dell'apparecchio nella prima pagina è puramente indicativa della tipologia di apparecchio sottoposto a test.

RISULTATI FOTOMETRICI

Tipo di misura fotometrica	Assoluta
LOR (%)	100.0
Flusso luminoso apparecchio (lm)	6820
Potenza ingresso apparecchio (W)	51.5
Efficienza apparecchio (lm/W)	132
Note e commenti	

LISTA STRUMENTAZIONE

CODICE AEC	STRUMENTO	COSTRUTTORE	MODELLO
Q129	Luxmetro	Czibula&Grundmann	100310
Q130	Goniofotometro	Oxytech	T2
Q131	Termoigrometro	Delta Ohm	HD2001
Q132	Wattmetro	N4L	PPA2510
Q135	Stabilizzatore	Elettrotest	TPS/M/9KW
Q205	Luxmetro	Czibula&Grundmann	161206

INCERTEZZA STRUMENTALE

Encoder goniofotometro Oxytech T2	Precisione angolare in C – gamma	$\pm 0.044^\circ$
Luxmetro C&G	f1'	< 1.23%
Wattmetro Kinetiq N4L PPA2510	Accuratezza di potenza	< [0.05% + 0.03%/pf + (0.01%/kHz)/pf] Rdg + 0.05%VA Rng

Apparecchio	Rilievo	Lampada
Codice COMPASS 1 2Z8 STU-W 3.50-2M	Codice 20-204_1120	Codice L-COM-2Z8-3000-500-2M-70-25
Nome COMPASS 1 2Z8 STU-W 3.50-2M	Nome COMPASS 1 2Z8 STU-W 3.50-2M	Numero 1
Archivio Eulumdat	Data 06-11-2020	Posizione

Flusso Apparecchio	6820.00 lm	Potenza Apparecchio	51.50 W	Efficacia	132.43 lm/W	Rendimento	100.00%
Flusso Lampade	6820.00 lm	Valore Massimo	601.14 cd/klm	Posizione	C=30.00 G=62.00	CG	Asimmetrico

Tabella Intensità Luminose - cd/klm Tabella 6/18

	C 325.00	C 330.00	C 335.00	C 340.00	C 345.00	C 350.00	C 355.00
G 0.0	297.51	297.51	297.51	297.51	297.51	297.51	297.51
G 1.0	296.67	296.85	296.94	296.88	296.81	296.83	297.00
G 2.0	294.95	295.26	295.33	295.37	295.64	295.90	296.14
G 3.0	293.30	293.52	293.80	294.15	294.46	294.68	294.78
G 4.0	291.64	291.84	292.28	292.65	292.93	293.28	293.81
G 5.0	290.12	290.61	291.08	291.51	291.95	292.53	293.25
G 6.0	288.82	289.60	290.29	290.89	291.64	292.50	293.29
G 7.0	287.85	288.78	289.88	290.69	291.76	292.66	293.65
G 8.0	286.88	288.31	289.59	290.63	291.91	292.96	294.08
G 9.0	285.90	287.66	289.25	290.64	292.14	293.40	294.66
G 10.0	284.86	287.15	289.06	290.98	292.71	294.21	295.73
G 11.0	283.87	286.83	289.23	291.74	293.80	295.52	297.14
G 12.0	283.17	286.80	289.64	292.64	294.96	296.96	298.57
G 13.0	282.61	286.69	290.11	293.50	296.00	298.25	299.82
G 14.0	281.86	286.46	290.36	294.01	296.79	299.03	300.69
G 15.0	280.94	285.85	290.28	294.22	297.23	299.49	301.08
G 16.0	279.70	285.04	289.92	294.08	297.15	299.41	301.10
G 17.0	278.19	283.89	289.04	293.23	296.57	298.93	300.68
G 18.0	276.51	282.35	287.65	291.99	295.72	298.21	299.98
G 19.0	274.40	280.42	286.00	290.67	294.61	297.35	299.24
G 20.0	272.13	277.97	283.93	289.10	293.47	296.46	298.47
G 21.0	269.49	275.37	281.66	287.37	292.20	295.52	297.71
G 22.0	266.76	272.97	279.40	285.59	290.93	294.68	297.09
G 23.0	263.84	270.29	277.24	283.94	289.75	294.00	296.58
G 24.0	261.07	267.54	275.06	282.20	288.55	293.32	296.10
G 25.0	257.76	264.86	272.63	280.33	287.50	292.71	295.75
G 26.0	252.19	262.13	270.22	278.48	286.37	292.23	295.58
G 27.0	245.55	259.42	267.74	276.82	285.24	291.83	295.60
G 28.0	236.45	255.22	265.27	275.08	284.23	291.51	295.75
G 29.0	226.48	250.18	262.87	273.12	283.20	291.21	296.05
G 30.0	214.31	244.12	260.66	271.02	282.20	291.02	296.48
G 31.0	200.44	237.13	257.89	268.89	281.26	290.91	297.09
G 32.0	186.50	228.17	254.00	266.77	280.13	290.90	297.89
G 33.0	173.37	218.22	249.32	264.78	278.84	290.89	298.73
G 34.0	159.64	205.84	243.48	262.83	277.42	290.89	299.69
G 35.0	145.73	193.39	237.07	260.49	275.86	290.89	300.57
G 36.0	131.90	181.08	229.51	257.16	274.27	290.78	301.52
G 37.0	118.50	168.44	220.59	252.97	272.55	290.52	302.38
G 38.0	104.58	155.54	210.28	248.24	270.87	290.10	303.21
G 39.0	91.16	142.66	198.87	242.91	269.06	289.48	303.95
G 40.0	77.61	130.05	187.31	237.31	267.00	288.67	304.53
G 41.0	65.07	117.15	174.87	231.51	264.84	287.67	305.14
G 42.0	53.65	104.35	162.24	224.66	261.89	286.41	305.52
G 43.0	43.92	91.81	149.96	216.24	258.15	285.10	305.84
G 44.0	36.65	79.33	138.22	206.69	253.53	283.75	306.02
G 45.0	33.40	67.62	126.61	196.83	248.39	282.22	305.97
G 46.0	30.18	57.56	114.06	186.52	243.25	280.46	305.77
G 47.0	30.10	48.52	101.93	175.75	237.80	278.51	305.37
G 48.0	29.93	41.08	90.14	164.41	232.21	276.36	304.92
G 49.0	29.56	35.79	78.81	152.90	226.81	274.13	304.47
G 50.0	28.80	33.26	68.70	140.82	220.75	271.78	304.19
G 51.0	28.02	32.86	59.24	128.51	213.46	268.78	304.01
G 52.0	27.25	32.63	50.54	117.13	204.98	265.22	303.89
G 53.0	26.66	32.26	42.90	106.05	195.66	261.25	303.70
G 54.0	26.32	31.67	37.88	95.74	185.33	256.74	303.16
G 55.0	26.21	30.85	36.08	85.48	174.52	252.07	301.54
G 56.0	26.27	30.05	35.34	75.38	162.49	245.62	296.06
G 57.0	26.53	29.43	34.64	65.01	149.05	235.73	285.86
G 58.0	27.04	28.99	33.90	54.56	135.18	223.95	274.00
G 59.0	27.75	28.80	32.98	46.25	121.30	210.70	261.63
G 60.0	28.70	29.01	31.95	41.24	107.44	196.46	251.13
G 61.0	29.98	29.41	30.88	38.76	92.70	181.93	243.03
G 62.0	31.55	30.19	30.13	36.56	78.34	169.04	235.00
G 63.0	33.42	31.31	29.80	34.64	65.71	156.63	226.59
G 64.0	35.79	32.86	29.85	32.86	54.73	143.21	216.75
G 65.0	38.15	34.78	30.36	31.42	45.76	129.51	205.25
G 66.0	41.02	37.04	31.24	30.52	40.43	116.07	193.35
G 67.0	43.88	39.68	32.49	29.65	35.76	102.63	180.44
G 68.0	46.65	42.63	34.24	29.14	32.93	89.20	167.69
G 69.0	48.85	45.58	36.37	29.07	30.37	77.50	153.97
G 70.0	50.44	48.30	38.66	29.28	28.37	66.23	142.12
G 71.0	51.31	50.63	41.17	29.85	26.71	55.21	128.37
G 72.0	51.11	52.21	43.43	30.65	25.38	45.44	109.56

Apparecchio		Rilievo		Lampada	
Codice	COMPASS 1 2Z8 STU-W 3.50-2M	Codice	20-204_1120	Codice	L-COM-2Z8-3000-500-2M-70-25
Nome	COMPASS 1 2Z8 STU-W 3.50-2M	Nome	COMPASS 1 2Z8 STU-W 3.50-2M	Numero	1
Archivio	Eulumdat	Data	06-11-2020	Posizione	

Flusso Apparecchio	6820.00 lm	Potenza Apparecchio	51.50 W	Efficacia	132.43 lm/W	Rendimento	100.00%
Flusso Lampade	6820.00 lm	Valore Massimo	601.14 cd/klm	Posizione	C=30.00 G=62.00	CG	Asimmetrico

Tabella Intensità Luminose - cd/klm Tabella 12/18

	C 325.00	C 330.00	C 335.00	C 340.00	C 345.00	C 350.00	C 355.00
G 73.0	49.84	52.82	45.17	31.56	24.29	36.96	90.59
G 74.0	47.27	52.25	46.38	32.64	23.44	31.36	75.19
G 75.0	43.81	50.25	46.80	33.70	22.70	27.55	61.38
G 76.0	38.94	47.15	46.16	34.54	22.09	23.64	49.31
G 77.0	33.85	43.15	44.41	34.98	21.55	20.21	38.57
G 78.0	28.02	37.56	41.35	34.70	20.97	17.22	29.37
G 79.0	22.06	31.15	36.84	33.27	20.18	14.42	22.25
G 80.0	16.39	24.41	31.22	30.18	18.92	12.30	16.58
G 81.0	11.63	18.15	24.75	25.55	17.01	10.23	11.99
G 82.0	7.74	12.53	18.11	20.03	14.53	8.32	8.49
G 83.0	4.66	7.97	12.21	13.85	11.42	6.58	6.03
G 84.0	2.62	4.54	7.12	8.33	7.84	4.92	4.12
G 85.0	1.38	2.22	3.34	4.40	4.73	3.38	2.79
G 86.0	0.70	1.04	1.35	1.92	2.12	1.94	1.82
G 87.0	0.36	0.50	0.55	0.72	0.69	0.89	1.10
G 88.0	0.19	0.26	0.27	0.31	0.32	0.40	0.53
G 89.0	0.02	0.05	0.07	0.11	0.14	0.22	0.31
G 90.0	0.00	0.00	0.00	0.00	0.00	0.00	0.00
G 91.0	0.00	0.00	0.00	0.00	0.00	0.00	0.00
G 92.0	0.00	0.00	0.00	0.00	0.00	0.00	0.00
G 93.0	0.00	0.00	0.00	0.00	0.00	0.00	0.00
G 94.0	0.00	0.00	0.00	0.00	0.00	0.00	0.00
G 95.0	0.00	0.00	0.00	0.00	0.00	0.00	0.00
G 96.0	0.00	0.00	0.00	0.00	0.00	0.00	0.00
G 97.0	0.00	0.00	0.00	0.00	0.00	0.00	0.00
G 98.0	0.00	0.00	0.00	0.00	0.00	0.00	0.00
G 99.0	0.00	0.00	0.00	0.00	0.00	0.00	0.00
G100.0	0.00	0.00	0.00	0.00	0.00	0.00	0.00
G101.0	0.00	0.00	0.00	0.00	0.00	0.00	0.00
G102.0	0.00	0.00	0.00	0.00	0.00	0.00	0.00
G103.0	0.00	0.00	0.00	0.00	0.00	0.00	0.00
G104.0	0.00	0.00	0.00	0.00	0.00	0.00	0.00
G105.0	0.00	0.00	0.00	0.00	0.00	0.00	0.00
G106.0	0.00	0.00	0.00	0.00	0.00	0.00	0.00
G107.0	0.00	0.00	0.00	0.00	0.00	0.00	0.00
G108.0	0.00	0.00	0.00	0.00	0.00	0.00	0.00
G109.0	0.00	0.00	0.00	0.00	0.00	0.00	0.00
G110.0	0.00	0.00	0.00	0.00	0.00	0.00	0.00
G111.0	0.00	0.00	0.00	0.00	0.00	0.00	0.00
G112.0	0.00	0.00	0.00	0.00	0.00	0.00	0.00
G113.0	0.00	0.00	0.00	0.00	0.00	0.00	0.00
G114.0	0.00	0.00	0.00	0.00	0.00	0.00	0.00
G115.0	0.00	0.00	0.00	0.00	0.00	0.00	0.00
G116.0	0.00	0.00	0.00	0.00	0.00	0.00	0.00
G117.0	0.00	0.00	0.00	0.00	0.00	0.00	0.00
G118.0	0.00	0.00	0.00	0.00	0.00	0.00	0.00
G119.0	0.00	0.00	0.00	0.00	0.00	0.00	0.00
G120.0	0.00	0.00	0.00	0.00	0.00	0.00	0.00
G121.0	0.00	0.00	0.00	0.00	0.00	0.00	0.00
G122.0	0.00	0.00	0.00	0.00	0.00	0.00	0.00
G123.0	0.00	0.00	0.00	0.00	0.00	0.00	0.00
G124.0	0.00	0.00	0.00	0.00	0.00	0.00	0.00
G125.0	0.00	0.00	0.00	0.00	0.00	0.00	0.00
G126.0	0.00	0.00	0.00	0.00	0.00	0.00	0.00
G127.0	0.00	0.00	0.00	0.00	0.00	0.00	0.00
G128.0	0.00	0.00	0.00	0.00	0.00	0.00	0.00
G129.0	0.00	0.00	0.00	0.00	0.00	0.00	0.00
G130.0	0.00	0.00	0.00	0.00	0.00	0.00	0.00
G131.0	0.00	0.00	0.00	0.00	0.00	0.00	0.00
G132.0	0.00	0.00	0.00	0.00	0.00	0.00	0.00
G133.0	0.00	0.00	0.00	0.00	0.00	0.00	0.00
G134.0	0.00	0.00	0.00	0.00	0.00	0.00	0.00
G135.0	0.00	0.00	0.00	0.00	0.00	0.00	0.00
G136.0	0.00	0.00	0.00	0.00	0.00	0.00	0.00
G137.0	0.00	0.00	0.00	0.00	0.00	0.00	0.00
G138.0	0.00	0.00	0.00	0.00	0.00	0.00	0.00
G139.0	0.00	0.00	0.00	0.00	0.00	0.00	0.00
G140.0	0.00	0.00	0.00	0.00	0.00	0.00	0.00
G141.0	0.00	0.00	0.00	0.00	0.00	0.00	0.00
G142.0	0.00	0.00	0.00	0.00	0.00	0.00	0.00
G143.0	0.00	0.00	0.00	0.00	0.00	0.00	0.00
G144.0	0.00	0.00	0.00	0.00	0.00	0.00	0.00
G145.0	0.00	0.00	0.00	0.00	0.00	0.00	0.00

Apparecchio		Rilievo		Lampada	
Codice	COMPASS 1 2Z8 STU-W 3.50-2M	Codice	20-204_1120	Codice	L-COM-2Z8-3000-500-2M-70-25
Nome	COMPASS 1 2Z8 STU-W 3.50-2M	Nome	COMPASS 1 2Z8 STU-W 3.50-2M	Numero	1
Archivio	Eulumdat	Data	06-11-2020	Posizione	

Flusso Apparecchio	6820.00 lm	Potenza Apparecchio	51.50 W	Efficacia	132.43 lm/W	Rendimento	100.00%
Flusso Lampade	6820.00 lm	Valore Massimo	601.14 cd/klm	Posizione	C=30.00 G=62.00	CG	Asimmetrico

Tabella Intensità Luminose - cd/klm Tabella 13/18

	C 0.00	C 5.00	C 10.00	C 15.00	C 20.00	C 25.00	C 30.00	C 35.00	C 40.00	C 45.00	C 50.00	C 55.00	C 60.00
G146.0	0.00	0.00	0.00	0.00	0.00	0.00	0.00	0.00	0.00	0.00	0.00	0.00	0.00
G147.0	0.00	0.00	0.00	0.00	0.00	0.00	0.00	0.00	0.00	0.00	0.00	0.00	0.00
G148.0	0.00	0.00	0.00	0.00	0.00	0.00	0.00	0.00	0.00	0.00	0.00	0.00	0.00
G149.0	0.00	0.00	0.00	0.00	0.00	0.00	0.00	0.00	0.00	0.00	0.00	0.00	0.00
G150.0	0.00	0.00	0.00	0.00	0.00	0.00	0.00	0.00	0.00	0.00	0.00	0.00	0.00
G151.0	0.00	0.00	0.00	0.00	0.00	0.00	0.00	0.00	0.00	0.00	0.00	0.00	0.00
G152.0	0.00	0.00	0.00	0.00	0.00	0.00	0.00	0.00	0.00	0.00	0.00	0.00	0.00
G153.0	0.00	0.00	0.00	0.00	0.00	0.00	0.00	0.00	0.00	0.00	0.00	0.00	0.00
G154.0	0.00	0.00	0.00	0.00	0.00	0.00	0.00	0.00	0.00	0.00	0.00	0.00	0.00
G155.0	0.00	0.00	0.00	0.00	0.00	0.00	0.00	0.00	0.00	0.00	0.00	0.00	0.00
G156.0	0.00	0.00	0.00	0.00	0.00	0.00	0.00	0.00	0.00	0.00	0.00	0.00	0.00
G157.0	0.00	0.00	0.00	0.00	0.00	0.00	0.00	0.00	0.00	0.00	0.00	0.00	0.00
G158.0	0.00	0.00	0.00	0.00	0.00	0.00	0.00	0.00	0.00	0.00	0.00	0.00	0.00
G159.0	0.00	0.00	0.00	0.00	0.00	0.00	0.00	0.00	0.00	0.00	0.00	0.00	0.00
G160.0	0.00	0.00	0.00	0.00	0.00	0.00	0.00	0.00	0.00	0.00	0.00	0.00	0.00
G161.0	0.00	0.00	0.00	0.00	0.00	0.00	0.00	0.00	0.00	0.00	0.00	0.00	0.00
G162.0	0.00	0.00	0.00	0.00	0.00	0.00	0.00	0.00	0.00	0.00	0.00	0.00	0.00
G163.0	0.00	0.00	0.00	0.00	0.00	0.00	0.00	0.00	0.00	0.00	0.00	0.00	0.00
G164.0	0.00	0.00	0.00	0.00	0.00	0.00	0.00	0.00	0.00	0.00	0.00	0.00	0.00
G165.0	0.00	0.00	0.00	0.00	0.00	0.00	0.00	0.00	0.00	0.00	0.00	0.00	0.00
G166.0	0.00	0.00	0.00	0.00	0.00	0.00	0.00	0.00	0.00	0.00	0.00	0.00	0.00
G167.0	0.00	0.00	0.00	0.00	0.00	0.00	0.00	0.00	0.00	0.00	0.00	0.00	0.00
G168.0	0.00	0.00	0.00	0.00	0.00	0.00	0.00	0.00	0.00	0.00	0.00	0.00	0.00
G169.0	0.00	0.00	0.00	0.00	0.00	0.00	0.00	0.00	0.00	0.00	0.00	0.00	0.00
G170.0	0.00	0.00	0.00	0.00	0.00	0.00	0.00	0.00	0.00	0.00	0.00	0.00	0.00
G171.0	0.00	0.00	0.00	0.00	0.00	0.00	0.00	0.00	0.00	0.00	0.00	0.00	0.00
G172.0	0.00	0.00	0.00	0.00	0.00	0.00	0.00	0.00	0.00	0.00	0.00	0.00	0.00
G173.0	0.00	0.00	0.00	0.00	0.00	0.00	0.00	0.00	0.00	0.00	0.00	0.00	0.00
G174.0	0.00	0.00	0.00	0.00	0.00	0.00	0.00	0.00	0.00	0.00	0.00	0.00	0.00
G175.0	0.00	0.00	0.00	0.00	0.00	0.00	0.00	0.00	0.00	0.00	0.00	0.00	0.00
G176.0	0.00	0.00	0.00	0.00	0.00	0.00	0.00	0.00	0.00	0.00	0.00	0.00	0.00
G177.0	0.00	0.00	0.00	0.00	0.00	0.00	0.00	0.00	0.00	0.00	0.00	0.00	0.00
G178.0	0.00	0.00	0.00	0.00	0.00	0.00	0.00	0.00	0.00	0.00	0.00	0.00	0.00
G179.0	0.00	0.00	0.00	0.00	0.00	0.00	0.00	0.00	0.00	0.00	0.00	0.00	0.00
G180.0	0.00	0.00	0.00	0.00	0.00	0.00	0.00	0.00	0.00	0.00	0.00	0.00	0.00

Apparecchio		Rilievo		Lampada	
Codice	COMPASS 1 2Z8 STU-W 3.50-2M	Codice	20-204_1120	Codice	L-COM-2Z8-3000-500-2M-70-25
Nome	COMPASS 1 2Z8 STU-W 3.50-2M	Nome	COMPASS 1 2Z8 STU-W 3.50-2M	Numero	1
Archivio	Eulumdat	Data	06-11-2020	Posizione	

Flusso Apparecchio	6820.00 lm	Potenza Apparecchio	51.50 W	Efficacia	132.43 lm/W	Rendimento	100.00%
Flusso Lampade	6820.00 lm	Valore Massimo	601.14 cd/klm	Posizione	C=30.00 G=62.00	CG	Asimmetrico

Tabella Intensità Luminose - cd/klm Tabella 14/18

	C 65.00	C 70.00	C 75.00	C 80.00	C 85.00	C 90.00	C 95.00	C 100.00	C 105.00	C 110.00	C 115.00	C 120.00	C 125.00
G146.0	0.00	0.00	0.00	0.00	0.00	0.00	0.00	0.00	0.00	0.00	0.00	0.00	0.00
G147.0	0.00	0.00	0.00	0.00	0.00	0.00	0.00	0.00	0.00	0.00	0.00	0.00	0.00
G148.0	0.00	0.00	0.00	0.00	0.00	0.00	0.00	0.00	0.00	0.00	0.00	0.00	0.00
G149.0	0.00	0.00	0.00	0.00	0.00	0.00	0.00	0.00	0.00	0.00	0.00	0.00	0.00
G150.0	0.00	0.00	0.00	0.00	0.00	0.00	0.00	0.00	0.00	0.00	0.00	0.00	0.00
G151.0	0.00	0.00	0.00	0.00	0.00	0.00	0.00	0.00	0.00	0.00	0.00	0.00	0.00
G152.0	0.00	0.00	0.00	0.00	0.00	0.00	0.00	0.00	0.00	0.00	0.00	0.00	0.00
G153.0	0.00	0.00	0.00	0.00	0.00	0.00	0.00	0.00	0.00	0.00	0.00	0.00	0.00
G154.0	0.00	0.00	0.00	0.00	0.00	0.00	0.00	0.00	0.00	0.00	0.00	0.00	0.00
G155.0	0.00	0.00	0.00	0.00	0.00	0.00	0.00	0.00	0.00	0.00	0.00	0.00	0.00
G156.0	0.00	0.00	0.00	0.00	0.00	0.00	0.00	0.00	0.00	0.00	0.00	0.00	0.00
G157.0	0.00	0.00	0.00	0.00	0.00	0.00	0.00	0.00	0.00	0.00	0.00	0.00	0.00
G158.0	0.00	0.00	0.00	0.00	0.00	0.00	0.00	0.00	0.00	0.00	0.00	0.00	0.00
G159.0	0.00	0.00	0.00	0.00	0.00	0.00	0.00	0.00	0.00	0.00	0.00	0.00	0.00
G160.0	0.00	0.00	0.00	0.00	0.00	0.00	0.00	0.00	0.00	0.00	0.00	0.00	0.00
G161.0	0.00	0.00	0.00	0.00	0.00	0.00	0.00	0.00	0.00	0.00	0.00	0.00	0.00
G162.0	0.00	0.00	0.00	0.00	0.00	0.00	0.00	0.00	0.00	0.00	0.00	0.00	0.00
G163.0	0.00	0.00	0.00	0.00	0.00	0.00	0.00	0.00	0.00	0.00	0.00	0.00	0.00
G164.0	0.00	0.00	0.00	0.00	0.00	0.00	0.00	0.00	0.00	0.00	0.00	0.00	0.00
G165.0	0.00	0.00	0.00	0.00	0.00	0.00	0.00	0.00	0.00	0.00	0.00	0.00	0.00
G166.0	0.00	0.00	0.00	0.00	0.00	0.00	0.00	0.00	0.00	0.00	0.00	0.00	0.00
G167.0	0.00	0.00	0.00	0.00	0.00	0.00	0.00	0.00	0.00	0.00	0.00	0.00	0.00
G168.0	0.00	0.00	0.00	0.00	0.00	0.00	0.00	0.00	0.00	0.00	0.00	0.00	0.00
G169.0	0.00	0.00	0.00	0.00	0.00	0.00	0.00	0.00	0.00	0.00	0.00	0.00	0.00
G170.0	0.00	0.00	0.00	0.00	0.00	0.00	0.00	0.00	0.00	0.00	0.00	0.00	0.00
G171.0	0.00	0.00	0.00	0.00	0.00	0.00	0.00	0.00	0.00	0.00	0.00	0.00	0.00
G172.0	0.00	0.00	0.00	0.00	0.00	0.00	0.00	0.00	0.00	0.00	0.00	0.00	0.00
G173.0	0.00	0.00	0.00	0.00	0.00	0.00	0.00	0.00	0.00	0.00	0.00	0.00	0.00
G174.0	0.00	0.00	0.00	0.00	0.00	0.00	0.00	0.00	0.00	0.00	0.00	0.00	0.00
G175.0	0.00	0.00	0.00	0.00	0.00	0.00	0.00	0.00	0.00	0.00	0.00	0.00	0.00
G176.0	0.00	0.00	0.00	0.00	0.00	0.00	0.00	0.00	0.00	0.00	0.00	0.00	0.00
G177.0	0.00	0.00	0.00	0.00	0.00	0.00	0.00	0.00	0.00	0.00	0.00	0.00	0.00
G178.0	0.00	0.00	0.00	0.00	0.00	0.00	0.00	0.00	0.00	0.00	0.00	0.00	0.00
G179.0	0.00	0.00	0.00	0.00	0.00	0.00	0.00	0.00	0.00	0.00	0.00	0.00	0.00
G180.0	0.00	0.00	0.00	0.00	0.00	0.00	0.00	0.00	0.00	0.00	0.00	0.00	0.00

Apparecchio		Rilievo		Lampada	
Codice	COMPASS 1 2Z8 STU-W 3.50-2M	Codice	20-204_1120	Codice	L-COM-2Z8-3000-500-2M-70-25
Nome	COMPASS 1 2Z8 STU-W 3.50-2M	Nome	COMPASS 1 2Z8 STU-W 3.50-2M	Numero	1
Archivio	Eulumdat	Data	06-11-2020	Posizione	

Flusso Apparecchio	6820.00 lm	Potenza Apparecchio	51.50 W	Efficacia	132.43 lm/W	Rendimento	100.00%
Flusso Lampade	6820.00 lm	Valore Massimo	601.14 cd/klm	Posizione	C=30.00 G=62.00	CG	Asimmetrico

Tabella Intensità Luminose - cd/klm Tabella 15/18

	C 130.00	C 135.00	C 140.00	C 145.00	C 150.00	C 155.00	C 160.00	C 165.00	C 170.00	C 175.00	C 180.00	C 185.00	C 190.00
G146.0	0.00	0.00	0.00	0.00	0.00	0.00	0.00	0.00	0.00	0.00	0.00	0.00	0.00
G147.0	0.00	0.00	0.00	0.00	0.00	0.00	0.00	0.00	0.00	0.00	0.00	0.00	0.00
G148.0	0.00	0.00	0.00	0.00	0.00	0.00	0.00	0.00	0.00	0.00	0.00	0.00	0.00
G149.0	0.00	0.00	0.00	0.00	0.00	0.00	0.00	0.00	0.00	0.00	0.00	0.00	0.00
G150.0	0.00	0.00	0.00	0.00	0.00	0.00	0.00	0.00	0.00	0.00	0.00	0.00	0.00
G151.0	0.00	0.00	0.00	0.00	0.00	0.00	0.00	0.00	0.00	0.00	0.00	0.00	0.00
G152.0	0.00	0.00	0.00	0.00	0.00	0.00	0.00	0.00	0.00	0.00	0.00	0.00	0.00
G153.0	0.00	0.00	0.00	0.00	0.00	0.00	0.00	0.00	0.00	0.00	0.00	0.00	0.00
G154.0	0.00	0.00	0.00	0.00	0.00	0.00	0.00	0.00	0.00	0.00	0.00	0.00	0.00
G155.0	0.00	0.00	0.00	0.00	0.00	0.00	0.00	0.00	0.00	0.00	0.00	0.00	0.00
G156.0	0.00	0.00	0.00	0.00	0.00	0.00	0.00	0.00	0.00	0.00	0.00	0.00	0.00
G157.0	0.00	0.00	0.00	0.00	0.00	0.00	0.00	0.00	0.00	0.00	0.00	0.00	0.00
G158.0	0.00	0.00	0.00	0.00	0.00	0.00	0.00	0.00	0.00	0.00	0.00	0.00	0.00
G159.0	0.00	0.00	0.00	0.00	0.00	0.00	0.00	0.00	0.00	0.00	0.00	0.00	0.00
G160.0	0.00	0.00	0.00	0.00	0.00	0.00	0.00	0.00	0.00	0.00	0.00	0.00	0.00
G161.0	0.00	0.00	0.00	0.00	0.00	0.00	0.00	0.00	0.00	0.00	0.00	0.00	0.00
G162.0	0.00	0.00	0.00	0.00	0.00	0.00	0.00	0.00	0.00	0.00	0.00	0.00	0.00
G163.0	0.00	0.00	0.00	0.00	0.00	0.00	0.00	0.00	0.00	0.00	0.00	0.00	0.00
G164.0	0.00	0.00	0.00	0.00	0.00	0.00	0.00	0.00	0.00	0.00	0.00	0.00	0.00
G165.0	0.00	0.00	0.00	0.00	0.00	0.00	0.00	0.00	0.00	0.00	0.00	0.00	0.00
G166.0	0.00	0.00	0.00	0.00	0.00	0.00	0.00	0.00	0.00	0.00	0.00	0.00	0.00
G167.0	0.00	0.00	0.00	0.00	0.00	0.00	0.00	0.00	0.00	0.00	0.00	0.00	0.00
G168.0	0.00	0.00	0.00	0.00	0.00	0.00	0.00	0.00	0.00	0.00	0.00	0.00	0.00
G169.0	0.00	0.00	0.00	0.00	0.00	0.00	0.00	0.00	0.00	0.00	0.00	0.00	0.00
G170.0	0.00	0.00	0.00	0.00	0.00	0.00	0.00	0.00	0.00	0.00	0.00	0.00	0.00
G171.0	0.00	0.00	0.00	0.00	0.00	0.00	0.00	0.00	0.00	0.00	0.00	0.00	0.00
G172.0	0.00	0.00	0.00	0.00	0.00	0.00	0.00	0.00	0.00	0.00	0.00	0.00	0.00
G173.0	0.00	0.00	0.00	0.00	0.00	0.00	0.00	0.00	0.00	0.00	0.00	0.00	0.00
G174.0	0.00	0.00	0.00	0.00	0.00	0.00	0.00	0.00	0.00	0.00	0.00	0.00	0.00
G175.0	0.00	0.00	0.00	0.00	0.00	0.00	0.00	0.00	0.00	0.00	0.00	0.00	0.00
G176.0	0.00	0.00	0.00	0.00	0.00	0.00	0.00	0.00	0.00	0.00	0.00	0.00	0.00
G177.0	0.00	0.00	0.00	0.00	0.00	0.00	0.00	0.00	0.00	0.00	0.00	0.00	0.00
G178.0	0.00	0.00	0.00	0.00	0.00	0.00	0.00	0.00	0.00	0.00	0.00	0.00	0.00
G179.0	0.00	0.00	0.00	0.00	0.00	0.00	0.00	0.00	0.00	0.00	0.00	0.00	0.00
G180.0	0.00	0.00	0.00	0.00	0.00	0.00	0.00	0.00	0.00	0.00	0.00	0.00	0.00

Apparecchio			Rilievo			Lampada			
Codice	COMPASS 1 2Z8 STU-W 3.50-2M		Codice	20-204_1120		Codice	L-COM-2Z8-3000-500-2M-70-25		
Nome	COMPASS 1 2Z8 STU-W 3.50-2M		Nome	COMPASS 1 2Z8 STU-W 3.50-2M		Numero	1		
Archivio	Eulumdat		Data	06-11-2020		Posizione			

Flusso Apparecchio	6820.00 lm	Potenza Apparecchio	51.50 W	Efficacia	132.43 lm/W	Rendimento	100.00%
Flusso Lampade	6820.00 lm	Valore Massimo	601.14 cd/klm	Posizione	C=30.00 G=62.00	CG	Asimmetrico

Tabella Intensità Luminosa - cd/klm Tabella 16/18

	C 195.00	C 200.00	C 205.00	C 210.00	C 215.00	C 220.00	C 225.00	C 230.00	C 235.00	C 240.00	C 245.00	C 250.00	C 255.00
G146.0	0.00	0.00	0.00	0.00	0.00	0.00	0.00	0.00	0.00	0.00	0.00	0.00	0.00
G147.0	0.00	0.00	0.00	0.00	0.00	0.00	0.00	0.00	0.00	0.00	0.00	0.00	0.00
G148.0	0.00	0.00	0.00	0.00	0.00	0.00	0.00	0.00	0.00	0.00	0.00	0.00	0.00
G149.0	0.00	0.00	0.00	0.00	0.00	0.00	0.00	0.00	0.00	0.00	0.00	0.00	0.00
G150.0	0.00	0.00	0.00	0.00	0.00	0.00	0.00	0.00	0.00	0.00	0.00	0.00	0.00
G151.0	0.00	0.00	0.00	0.00	0.00	0.00	0.00	0.00	0.00	0.00	0.00	0.00	0.00
G152.0	0.00	0.00	0.00	0.00	0.00	0.00	0.00	0.00	0.00	0.00	0.00	0.00	0.00
G153.0	0.00	0.00	0.00	0.00	0.00	0.00	0.00	0.00	0.00	0.00	0.00	0.00	0.00
G154.0	0.00	0.00	0.00	0.00	0.00	0.00	0.00	0.00	0.00	0.00	0.00	0.00	0.00
G155.0	0.00	0.00	0.00	0.00	0.00	0.00	0.00	0.00	0.00	0.00	0.00	0.00	0.00
G156.0	0.00	0.00	0.00	0.00	0.00	0.00	0.00	0.00	0.00	0.00	0.00	0.00	0.00
G157.0	0.00	0.00	0.00	0.00	0.00	0.00	0.00	0.00	0.00	0.00	0.00	0.00	0.00
G158.0	0.00	0.00	0.00	0.00	0.00	0.00	0.00	0.00	0.00	0.00	0.00	0.00	0.00
G159.0	0.00	0.00	0.00	0.00	0.00	0.00	0.00	0.00	0.00	0.00	0.00	0.00	0.00
G160.0	0.00	0.00	0.00	0.00	0.00	0.00	0.00	0.00	0.00	0.00	0.00	0.00	0.00
G161.0	0.00	0.00	0.00	0.00	0.00	0.00	0.00	0.00	0.00	0.00	0.00	0.00	0.00
G162.0	0.00	0.00	0.00	0.00	0.00	0.00	0.00	0.00	0.00	0.00	0.00	0.00	0.00
G163.0	0.00	0.00	0.00	0.00	0.00	0.00	0.00	0.00	0.00	0.00	0.00	0.00	0.00
G164.0	0.00	0.00	0.00	0.00	0.00	0.00	0.00	0.00	0.00	0.00	0.00	0.00	0.00
G165.0	0.00	0.00	0.00	0.00	0.00	0.00	0.00	0.00	0.00	0.00	0.00	0.00	0.00
G166.0	0.00	0.00	0.00	0.00	0.00	0.00	0.00	0.00	0.00	0.00	0.00	0.00	0.00
G167.0	0.00	0.00	0.00	0.00	0.00	0.00	0.00	0.00	0.00	0.00	0.00	0.00	0.00
G168.0	0.00	0.00	0.00	0.00	0.00	0.00	0.00	0.00	0.00	0.00	0.00	0.00	0.00
G169.0	0.00	0.00	0.00	0.00	0.00	0.00	0.00	0.00	0.00	0.00	0.00	0.00	0.00
G170.0	0.00	0.00	0.00	0.00	0.00	0.00	0.00	0.00	0.00	0.00	0.00	0.00	0.00
G171.0	0.00	0.00	0.00	0.00	0.00	0.00	0.00	0.00	0.00	0.00	0.00	0.00	0.00
G172.0	0.00	0.00	0.00	0.00	0.00	0.00	0.00	0.00	0.00	0.00	0.00	0.00	0.00
G173.0	0.00	0.00	0.00	0.00	0.00	0.00	0.00	0.00	0.00	0.00	0.00	0.00	0.00
G174.0	0.00	0.00	0.00	0.00	0.00	0.00	0.00	0.00	0.00	0.00	0.00	0.00	0.00
G175.0	0.00	0.00	0.00	0.00	0.00	0.00	0.00	0.00	0.00	0.00	0.00	0.00	0.00
G176.0	0.00	0.00	0.00	0.00	0.00	0.00	0.00	0.00	0.00	0.00	0.00	0.00	0.00
G177.0	0.00	0.00	0.00	0.00	0.00	0.00	0.00	0.00	0.00	0.00	0.00	0.00	0.00
G178.0	0.00	0.00	0.00	0.00	0.00	0.00	0.00	0.00	0.00	0.00	0.00	0.00	0.00
G179.0	0.00	0.00	0.00	0.00	0.00	0.00	0.00	0.00	0.00	0.00	0.00	0.00	0.00
G180.0	0.00	0.00	0.00	0.00	0.00	0.00	0.00	0.00	0.00	0.00	0.00	0.00	0.00

Apparecchio		Rilievo		Lampada	
Codice	COMPASS 1 2Z8 STU-W 3.50-2M	Codice	20-204_1120	Codice	L-COM-2Z8-3000-500-2M-70-25
Nome	COMPASS 1 2Z8 STU-W 3.50-2M	Nome	COMPASS 1 2Z8 STU-W 3.50-2M	Numero	1
Archivio	Eulumdat	Data	06-11-2020	Posizione	

Flusso Apparecchio	6820.00 lm	Potenza Apparecchio	51.50 W	Efficacia	132.43 lm/W	Rendimento	100.00%
Flusso Lampade	6820.00 lm	Valore Massimo	601.14 cd/klm	Posizione	C=30.00 G=62.00	CG	Asimmetrico

Tabella Intensità Luminose - cd/klm Tabella 17/18

	C 260.00	C 265.00	C 270.00	C 275.00	C 280.00	C 285.00	C 290.00	C 295.00	C 300.00	C 305.00	C 310.00	C 315.00	C 320.00
G146.0	0.00	0.00	0.00	0.00	0.00	0.00	0.00	0.00	0.00	0.00	0.00	0.00	0.00
G147.0	0.00	0.00	0.00	0.00	0.00	0.00	0.00	0.00	0.00	0.00	0.00	0.00	0.00
G148.0	0.00	0.00	0.00	0.00	0.00	0.00	0.00	0.00	0.00	0.00	0.00	0.00	0.00
G149.0	0.00	0.00	0.00	0.00	0.00	0.00	0.00	0.00	0.00	0.00	0.00	0.00	0.00
G150.0	0.00	0.00	0.00	0.00	0.00	0.00	0.00	0.00	0.00	0.00	0.00	0.00	0.00
G151.0	0.00	0.00	0.00	0.00	0.00	0.00	0.00	0.00	0.00	0.00	0.00	0.00	0.00
G152.0	0.00	0.00	0.00	0.00	0.00	0.00	0.00	0.00	0.00	0.00	0.00	0.00	0.00
G153.0	0.00	0.00	0.00	0.00	0.00	0.00	0.00	0.00	0.00	0.00	0.00	0.00	0.00
G154.0	0.00	0.00	0.00	0.00	0.00	0.00	0.00	0.00	0.00	0.00	0.00	0.00	0.00
G155.0	0.00	0.00	0.00	0.00	0.00	0.00	0.00	0.00	0.00	0.00	0.00	0.00	0.00
G156.0	0.00	0.00	0.00	0.00	0.00	0.00	0.00	0.00	0.00	0.00	0.00	0.00	0.00
G157.0	0.00	0.00	0.00	0.00	0.00	0.00	0.00	0.00	0.00	0.00	0.00	0.00	0.00
G158.0	0.00	0.00	0.00	0.00	0.00	0.00	0.00	0.00	0.00	0.00	0.00	0.00	0.00
G159.0	0.00	0.00	0.00	0.00	0.00	0.00	0.00	0.00	0.00	0.00	0.00	0.00	0.00
G160.0	0.00	0.00	0.00	0.00	0.00	0.00	0.00	0.00	0.00	0.00	0.00	0.00	0.00
G161.0	0.00	0.00	0.00	0.00	0.00	0.00	0.00	0.00	0.00	0.00	0.00	0.00	0.00
G162.0	0.00	0.00	0.00	0.00	0.00	0.00	0.00	0.00	0.00	0.00	0.00	0.00	0.00
G163.0	0.00	0.00	0.00	0.00	0.00	0.00	0.00	0.00	0.00	0.00	0.00	0.00	0.00
G164.0	0.00	0.00	0.00	0.00	0.00	0.00	0.00	0.00	0.00	0.00	0.00	0.00	0.00
G165.0	0.00	0.00	0.00	0.00	0.00	0.00	0.00	0.00	0.00	0.00	0.00	0.00	0.00
G166.0	0.00	0.00	0.00	0.00	0.00	0.00	0.00	0.00	0.00	0.00	0.00	0.00	0.00
G167.0	0.00	0.00	0.00	0.00	0.00	0.00	0.00	0.00	0.00	0.00	0.00	0.00	0.00
G168.0	0.00	0.00	0.00	0.00	0.00	0.00	0.00	0.00	0.00	0.00	0.00	0.00	0.00
G169.0	0.00	0.00	0.00	0.00	0.00	0.00	0.00	0.00	0.00	0.00	0.00	0.00	0.00
G170.0	0.00	0.00	0.00	0.00	0.00	0.00	0.00	0.00	0.00	0.00	0.00	0.00	0.00
G171.0	0.00	0.00	0.00	0.00	0.00	0.00	0.00	0.00	0.00	0.00	0.00	0.00	0.00
G172.0	0.00	0.00	0.00	0.00	0.00	0.00	0.00	0.00	0.00	0.00	0.00	0.00	0.00
G173.0	0.00	0.00	0.00	0.00	0.00	0.00	0.00	0.00	0.00	0.00	0.00	0.00	0.00
G174.0	0.00	0.00	0.00	0.00	0.00	0.00	0.00	0.00	0.00	0.00	0.00	0.00	0.00
G175.0	0.00	0.00	0.00	0.00	0.00	0.00	0.00	0.00	0.00	0.00	0.00	0.00	0.00
G176.0	0.00	0.00	0.00	0.00	0.00	0.00	0.00	0.00	0.00	0.00	0.00	0.00	0.00
G177.0	0.00	0.00	0.00	0.00	0.00	0.00	0.00	0.00	0.00	0.00	0.00	0.00	0.00
G178.0	0.00	0.00	0.00	0.00	0.00	0.00	0.00	0.00	0.00	0.00	0.00	0.00	0.00
G179.0	0.00	0.00	0.00	0.00	0.00	0.00	0.00	0.00	0.00	0.00	0.00	0.00	0.00
G180.0	0.00	0.00	0.00	0.00	0.00	0.00	0.00	0.00	0.00	0.00	0.00	0.00	0.00

Apparecchio		Rilievo		Lampada	
Codice	COMPASS 1 2Z8 STU-W 3.50-2M	Codice	20-204_1120	Codice	L-COM-2Z8-3000-500-2M-70-25
Nome	COMPASS 1 2Z8 STU-W 3.50-2M	Nome	COMPASS 1 2Z8 STU-W 3.50-2M	Numero	1
Archivio	Eulumdat	Data	06-11-2020	Posizione	

Flusso Apparecchio	6820.00 lm	Potenza Apparecchio	51.50 W	Efficacia	132.43 lm/W	Rendimento	100.00%
Flusso Lampade	6820.00 lm	Valore Massimo	601.14 cd/klm	Posizione	C=30.00 G=62.00	CG	Asimmetrico

Tabella Intensità Luminosa - cd/klm Tabella 18/18

	C 325.00	C 330.00	C 335.00	C 340.00	C 345.00	C 350.00	C 355.00
G146.0	0.00	0.00	0.00	0.00	0.00	0.00	0.00
G147.0	0.00	0.00	0.00	0.00	0.00	0.00	0.00
G148.0	0.00	0.00	0.00	0.00	0.00	0.00	0.00
G149.0	0.00	0.00	0.00	0.00	0.00	0.00	0.00
G150.0	0.00	0.00	0.00	0.00	0.00	0.00	0.00
G151.0	0.00	0.00	0.00	0.00	0.00	0.00	0.00
G152.0	0.00	0.00	0.00	0.00	0.00	0.00	0.00
G153.0	0.00	0.00	0.00	0.00	0.00	0.00	0.00
G154.0	0.00	0.00	0.00	0.00	0.00	0.00	0.00
G155.0	0.00	0.00	0.00	0.00	0.00	0.00	0.00
G156.0	0.00	0.00	0.00	0.00	0.00	0.00	0.00
G157.0	0.00	0.00	0.00	0.00	0.00	0.00	0.00
G158.0	0.00	0.00	0.00	0.00	0.00	0.00	0.00
G159.0	0.00	0.00	0.00	0.00	0.00	0.00	0.00
G160.0	0.00	0.00	0.00	0.00	0.00	0.00	0.00
G161.0	0.00	0.00	0.00	0.00	0.00	0.00	0.00
G162.0	0.00	0.00	0.00	0.00	0.00	0.00	0.00
G163.0	0.00	0.00	0.00	0.00	0.00	0.00	0.00
G164.0	0.00	0.00	0.00	0.00	0.00	0.00	0.00
G165.0	0.00	0.00	0.00	0.00	0.00	0.00	0.00
G166.0	0.00	0.00	0.00	0.00	0.00	0.00	0.00
G167.0	0.00	0.00	0.00	0.00	0.00	0.00	0.00
G168.0	0.00	0.00	0.00	0.00	0.00	0.00	0.00
G169.0	0.00	0.00	0.00	0.00	0.00	0.00	0.00
G170.0	0.00	0.00	0.00	0.00	0.00	0.00	0.00
G171.0	0.00	0.00	0.00	0.00	0.00	0.00	0.00
G172.0	0.00	0.00	0.00	0.00	0.00	0.00	0.00
G173.0	0.00	0.00	0.00	0.00	0.00	0.00	0.00
G174.0	0.00	0.00	0.00	0.00	0.00	0.00	0.00
G175.0	0.00	0.00	0.00	0.00	0.00	0.00	0.00
G176.0	0.00	0.00	0.00	0.00	0.00	0.00	0.00
G177.0	0.00	0.00	0.00	0.00	0.00	0.00	0.00
G178.0	0.00	0.00	0.00	0.00	0.00	0.00	0.00
G179.0	0.00	0.00	0.00	0.00	0.00	0.00	0.00
G180.0	0.00	0.00	0.00	0.00	0.00	0.00	0.00

Apparecchio		Rilievo		Lampada			
Codice	COMPASS 1 2Z8 STU-W 3.50-2M	Codice	20-204_1120	Codice	L-COM-2Z8-3000-500-2M-70-25		
Nome	COMPASS 1 2Z8 STU-W 3.50-2M	Nome	COMPASS 1 2Z8 STU-W 3.50-2M	Numero	1		
Archivio	Eulumdat	Data	06-11-2020	Posizione			
Flusso Apparecchio	6820.00 lm	Potenza Apparecchio	51.50 W	Efficacia	132.43 lm/W	Rendimento	100.00%
Flusso Lampade	6820.00 lm	Valore Massimo	601.14 cd/klm	Posizione	C=30.00 G=62.00	CG	Asimmetrico
Apparecchio Circolare	Diam.	540 mm	Alt.	85 mm	Alt.		0 mm
Area Luminosa Rettangolare	Lung.	95 mm	Larg.	225 mm			
Area Luminosa Orizzontale	0.021375 m2	Area Luminosa Piano 180°		0.000000 m2			
Area Luminosa Piano 0°	0.000000 m2	Area Luminosa Piano 270°		0.000000 m2			
Area Luminosa Piano 90°	0.000000 m2	Area Luminosa a 76°		0.005171 m2			
Sistema Coordinate	CG	Tipo di Simmetria		Asimmetrico			
Data	06-11-2020	Massimo Angolo Gamma		180			
Lampade Apparecchio							
Archivio	Codice	Nome	Flusso [lm]	Pot. [W]	Q.tà		
	L-COM-2Z8-3000-500-2M-70-25	L-COM-2Z8-3000-500-2M-70-25 - 51.50 W	6820.00	51.50	1		
C.I.E.	39 74 97 100 100	D DIN 5040	A20				
F UTE	1.00 E	B NBN	BZ 5				

Diam=540mm

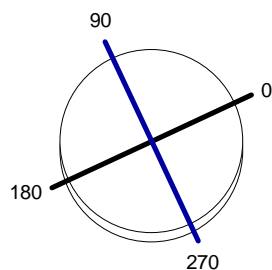

Semipiani C



ULOR 0.00 %
DLOR 100.00 %
RN 0.00 %

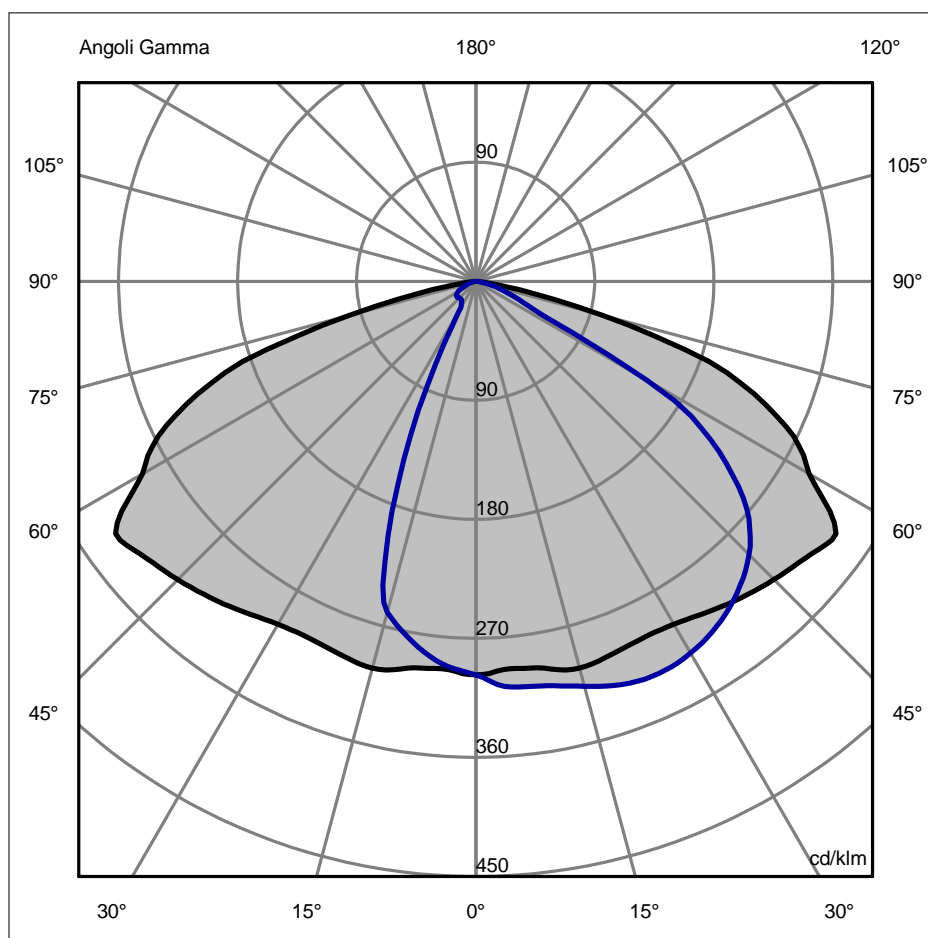

Apparecchio		Rilievo		Lampada	
Codice	COMPASS 1 2Z8 STU-W 3.50-2M	Codice	20-204_1120	Codice	L-COM-2Z8-3000-500-2M-70-25
Nome	COMPASS 1 2Z8 STU-W 3.50-2M	Nome	COMPASS 1 2Z8 STU-W 3.50-2M	Numero	1
Archivio	Eulumdat	Data	06-11-2020	Posizione	

Flusso Apparecchio	6820.00 lm	Potenza Apparecchio	51.50 W	Efficacia	132.43 lm/W	Rendimento	100.00%
Flusso Lampade	6820.00 lm	Valore Massimo	601.14 cd/klm	Posizione	C=30.00 G=62.00	CG	Asimmetrico

Marciapiede			Strada		
Piano	0	0.00%	Piano	0	0.00%
Piano	-5	4.95%	Piano	5	5.13%
Piano	-10	9.64%	Piano	10	10.41%
Piano	-15	13.94%	Piano	15	15.86%
Piano	-20	17.50%	Piano	20	21.60%
Piano	-25	19.71%	Piano	25	27.67%
Piano	-30	20.64%	Piano	30	34.05%
Piano	-35	21.11%	Piano	35	40.68%
Piano	-40	21.52%	Piano	40	47.45%
Piano	-45	21.90%	Piano	45	54.23%
Piano	-50	22.30%	Piano	50	60.77%
Piano	-55	22.73%	Piano	55	66.68%
Piano	-60	23.19%	Piano	60	71.50%
Piano	-65	23.61%	Piano	65	74.18%
Piano	-70	23.92%	Piano	70	75.24%
Piano	-75	24.09%	Piano	75	75.62%
Piano	-80	24.14%	Piano	80	75.77%
Piano	-85	24.16%	Piano	85	75.83%
Piano	-90	24.16%	Piano	90	75.84%

Angolo Inclinazione = 0.0

DLOR = 100.00%

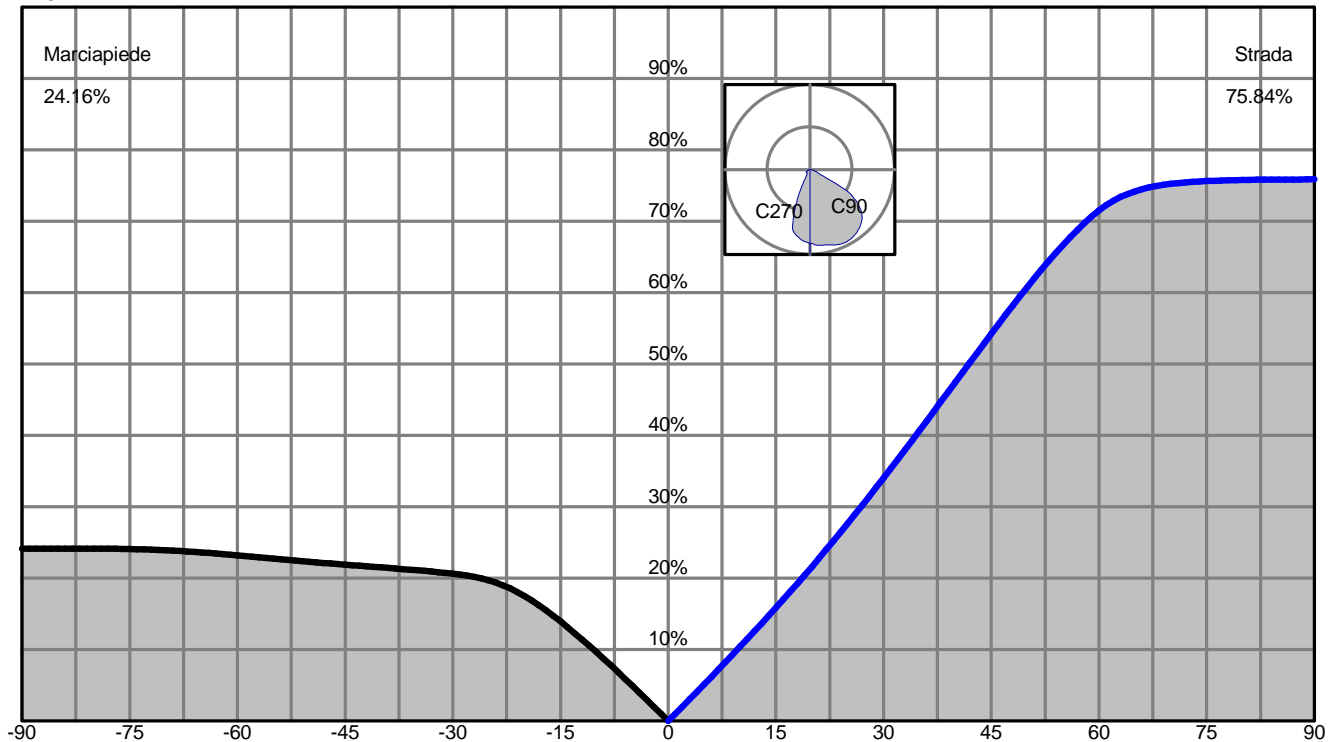

Spread	52.2° Medio	DLOR	100.00000 %
Throw	62.5° Intermedio	ULOR	0.00000 %
SLI	5.1 Ristretto	Rendimento	100.00000 %
Cutoff CIE	Cutoff - Max: C=30.0° Gamma=62.0°	RN	0.00000 %
Cutoff Iesna	Full Cutoff	Classe Intensità Luminosa	G3
DIN5044	KB2	Indice Abbagliamento	D4
IESNA Type III Short Asymmetrical			



ECO·RAYS

ECO-RAYS TP

CARATTERISTICHE PRINCIPALI

Applicazioni	Illuminazione stradale e urbana.
Gruppo ottico	<p>STU-M/S: Ottica asimmetrica per illuminazione stradale, urbana e ciclopedonale.</p> <p>SV/SV2: Ottica asimmetrica per illuminazione di svincoli autostradali o strade urbane molto strette.</p> <p>S05: Ottica asimmetrica per illuminazione stradale, urbana e aree verdi.</p> <p>S: Ottica simmetrica per illuminazione urbana e aree verdi.</p> <p>STE-M/S: Ottica asimmetrica per illuminazione stradale extraurbana.</p> <p>STW: Ottica asimmetrica per illuminazione di strade larghe e urbane e extraurbane, specifica per asfalti bagnati.</p> <p>Temperatura di colore: 4000K (3000K in opzione) CRI ≥ 70</p> <p>LOR= 100%, DLOR= 100%, ULOR= 0%</p> <p>Classe di sicurezza fotobiologica: EXEMPT GROUP</p> <p>Efficienza sorgente LED: 168 lm/W @ 525mA, Tj=85°C, 4000K</p>
Classe di isolamento	II, I
Grado di protezione	IP66 IK08 totale
Moduli LED	Rimovibili
Inclinazione	0°
Dimensioni	Ø497x665x81mm
Peso	max. 8.5 kg
Superficie esposta	Laterale: 0.07m ² – Pianta: 0.17m ²
Montaggio	Testa palo Ø60-Ø76mm
Cablaggio	Piastra cablaggio rimovibile
Temp. di esercizio	-40°C / +50°C
Temp. di stoccaggio	-40°C / +80°C
Norme di riferimento	EN 60598-1, EN 60598-2-3, EN 62471, EN 55015, EN 61547, EN 61000-3-2, EN 61000-3-3



CARATTERISTICHE ELETTRICHE

Alimentazione	220÷240V 50/60Hz
Fattore di potenza	>0,9 (a pieno carico)
Connessione rete	Cavo uscente H07RN-F nx1.5mm ² In opzione: connettore esterno M/F IP66/68 per cavi sezione max. 2.5mm ² , Ø max. 12mm
Protez. sovratensioni	Fino a 10kV Con SPD (in opzione) 10kV / 10kV CM/DM
SPD (in opzione)	10kV-10kA, type II, completo di LED di segnalazione e termofusibile per disconnessione del carico a fine vita.
Sistema di controllo (opzioni)	<p>F: Fisso non dimmerabile.</p> <p>DA: Dimmerazione automatica (mezzanotte virtuale) con profilo di default.</p> <p>DAC: Profilo DA custom.</p> <p>FLC: Flusso luminoso costante.</p> <p>WL: Telecontrollo punto/punto ad onde radio.</p> <p>DALI: Interfaccia di dimmerazione digitale DALI.</p> <p>NEMA: Presa 7 pin (ANSI C136.41).</p> <p>ZHAGA: Presa 4 pin (ZHAGA Book 18).</p>
Vita gruppo ottico (Tq=25°C, 700mA)	>100.000hr L90B10 >100.000hr L90, TM-21

MATERIALI

Attacco	Alluminio pressofuso UNI EN1706. Verniciato a polveri.
Corpo	
Gruppo ottico	Alluminio 99.95% con finitura superficiale realizzata con deposizione sotto vuoto 99.95%. (Alluminio classe A+ DIN EN 16268)
Schermo	Vetro piano temperato sp. 4mm elevata trasparenza.
Pressacavo	Plastico M20x1.5 - IP68
Guarnizione	Poliuretana
Colore	Grafite - Cod. 01

Profilo DA

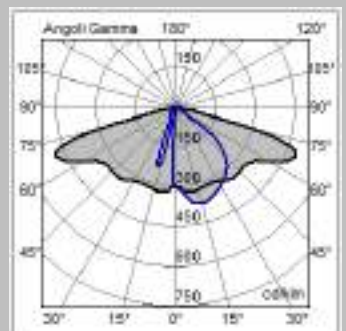
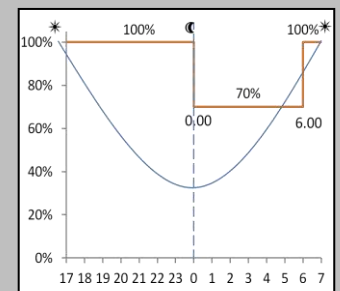

Ottica STU-M

Tutti i dati fotometrici pubblicati sono stati rilevati in conformità alle norme UNI EN 13032-1 e IES LM 79-08

GREENLIGHT



APPARECCHIO	OTTICA	FLUSSO APPARECCHIO* (Tq=25°C, 4000K, lm)	POTENZA APPARECCHIO* (Tq=25°C, Vin=230Vac, F/DA/DAC, W)	EFFICIENZA APPARECCHIO (Tq=25°C, lm/W)	FLUSSO NOMINALE LED* (Tj=85°C, 4000K, lm)	POTENZA NOMINALE LED* (Tj=85°C, W)
ECO RAYS TP 0F2H1 S 4.5-2M	S	3580	30.5	117	4368	26
ECO RAYS TP 0F2H1 S 4.7-2M	S	4580	40	114	5530	36
ECO RAYS TP 0F2H1 S05 4.5-1M	S05	1830	16	114	2184	13
ECO RAYS TP 0F2H1 S05 4.5-2M		3580	30.5	117	4368	26
ECO RAYS TP 0F2H1 S05 4.7-1M	S05	2350	21.5	109	2765	18
ECO RAYS TP 0F2H1 S05 4.7-2M		4580	40	114	5530	36
ECO RAYS TP 0F2H1 STU-M 4.5-1M	STU-M	1790	16	111	2184	13
ECO RAYS TP 0F2H1 STU-M 4.5-2M		3510	30.5	115	4368	26
ECO RAYS TP 0F2H1 STU-M 4.7-1M	STU-M	2300	21.5	106	2765	18
ECO RAYS TP 0F2H1 STU-M 4.7-2M		4480	40	112	5530	36
ECO RAYS TP 0F2H1 STU-S 4.5-1M	STU-S	1790	16	111	2184	13
ECO RAYS TP 0F2H1 STU-S 4.5-2M		3510	30.5	115	4368	26
ECO RAYS TP 0F2H1 STU-S 4.7-1M	STU-S	2300	21.5	106	2765	18
ECO RAYS TP 0F2H1 STU-S 4.7-2M		4480	40	112	5530	36
ECO RAYS TP 0F2H1 SV 4.5-1M	SV	1850	16	115	2184	13
ECO RAYS TP 0F2H1 SV 4.5-2M		3470	30.5	113	4368	26
ECO RAYS TP 0F2H1 SV 4.7-1M	SV	2270	21.5	105	2765	18
ECO RAYS TP 0F2H1 SV 4.7-2M		4440	40	111	5530	36



APPARECCHIO	OTTICA	FLUSSO APPARECCHIO* (Tq=25°C, 4000K, lm)	POTENZA APPARECCHIO* (Tq=25°C, Vin=230Vac, F/DA/DAC, W)	EFFICIENZA APPARECCHIO (Tq=25°C, lm/W)	FLUSSO NOMINALE LED* (Tj=85°C, 4000K, lm)	POTENZA NOMINALE LED* (Tj=85°C, W)
ECO RAYS TP 0F2H1 SV2 4.5-1M	SV2	1890	16	118	2184	13
ECO RAYS TP 0F2H1 SV2 4.5-2M		3540	30.5	116	4368	26
ECO RAYS TP 0F2H1 SV2 4.7-1M	SV2	2310	21.5	107	2765	18
ECO RAYS TP 0F2H1 SV2 4.7-2M		4530	40	113	5530	36
ECO RAYS TP 0F3 STE-M 4.5-1M	STE-M	2560	21.5	119	2950	17
ECO RAYS TP 0F3 STE-M 4.5-2M		4850	39	124	5900	34
ECO RAYS TP 0F3 STE-M 4.7-1M	STE-M	3070	28	109	3735	24
ECO RAYS TP 0F3 STE-M 4.7-2M		6140	52	118	7470	48
ECO RAYS TP 0F3 STE-S 4.5-1M	STE-S	2560	21.5	119	2950	17
ECO RAYS TP 0F3 STE-S 4.5-2M		4850	39	124	5900	34
ECO RAYS TP 0F3 STE-S 4.7-1M	STE-S	3070	28	109	3735	24
ECO RAYS TP 0F3 STE-S 4.7-2M		6140	52	118	7470	48
ECO RAYS TP 0F3 STW 4.5-1M	STW	2560	21.5	119	2950	17
ECO RAYS TP 0F3 STW 4.5-2M		4850	39	124	5900	34
ECO RAYS TP 0F3 STW 4.7-1M	STW	3070	28	109	3735	24
ECO RAYS TP 0F3 STW 4.7-2M		6140	52	118	7470	48

*FLUSSO APPARECCHIO / POTENZA APPARECCHIO: Dati nominali rilevati in laboratorio.

*FLUSSO NOMINALE LED / POTENZA NOMINALE LED: Dati nominali estrapolati da datasheet costruttore LED.

I valori indicati in questa scheda tecnica sono da considerarsi valori nominali. Tolleranza su flusso: +/-7%. Tolleranza su potenza: +/-5%.

Tolleranza su potenza in versioni ZHAGA o con alimentatore D4i/SR: +/-10%.

Al fine di favorire un costante aggiornamento dei propri prodotti, AEC si riserva il diritto di apportare modifiche senza preavviso.



APPARECCHIO	OTTICA	FLUSSO APPARECCHIO* (Tq=25°C, 3000K, lm)	POTENZA APPARECCHIO* (Tq=25°C, Vin=230Vac, F/DA/DAC, W)	EFFICIENZA APPARECCHIO (Tq=25°C, lm/W)	FLUSSO NOMINALE LED* (Tj=85°C, 3000K, lm)	POTENZA NOMINALE LED* (Tj=85°C, W)
ECO RAYS TP 0F2H1 S 3.5-2M	S	3330	30.5	109	3980	26
ECO RAYS TP 0F2H1 S 3.7-2M	S	4260	40	106	5040	36
ECO RAYS TP 0F2H1 S05 3.5-1M	S05	1700	16	106	1990	13
ECO RAYS TP 0F2H1 S05 3.5-2M		3330	30.5	109	3980	26
ECO RAYS TP 0F2H1 S05 3.7-1M	S05	2190	21.5	101	2520	18
ECO RAYS TP 0F2H1 S05 3.7-2M		4260	40	106	5040	36
ECO RAYS TP 0F2H1 STU-M 3.5-1M	STU-M	1660	16	103	1990	13
ECO RAYS TP 0F2H1 STU-M 3.5-2M		3260	30.5	106	3980	26
ECO RAYS TP 0F2H1 STU-M 3.7-1M	STU-M	2140	21.5	99	2520	18
ECO RAYS TP 0F2H1 STU-M 3.7-2M		4170	40	104	5040	36
ECO RAYS TP 0F2H1 STU-S 3.5-1M	STU-S	1660	16	103	1990	13
ECO RAYS TP 0F2H1 STU-S 3.5-2M		3260	30.5	106	3980	26
ECO RAYS TP 0F2H1 STU-S 3.7-1M	STU-S	2140	21.5	99	2520	18
ECO RAYS TP 0F2H1 STU-S 3.7-2M		4170	40	104	5040	36
ECO RAYS TP 0F2H1 SV 3.5-1M	SV	1720	16	107	1990	13
ECO RAYS TP 0F2H1 SV 3.5-2M		3230	30.5	105	3980	26
ECO RAYS TP 0F2H1 SV 3.7-1M	SV	2110	21.5	98	2520	18
ECO RAYS TP 0F2H1 SV 3.7-2M		4130	40	103	5040	36



APPARECCHIO	OTTICA	FLUSSO APPARECCHIO* (Tq=25°C, 3000K, lm)	POTENZA APPARECCHIO* (Tq=25°C, Vin=230Vac, F/DA/DAC, W)	EFFICIENZA APPARECCHIO (Tq=25°C, lm/W)	FLUSSO NOMINALE LED* (Tj=85°C, 3000K, lm)	POTENZA NOMINALE LED* (Tj=85°C, W)
ECO RAYS TP 0F2H1 SV2 3.5-1M	SV2	1760	16	110	1990	13
ECO RAYS TP 0F2H1 SV2 3.5-2M		3290	30.5	107	3980	26
ECO RAYS TP 0F2H1 SV2 3.7-1M	SV2	2150	21.5	100	2520	18
ECO RAYS TP 0F2H1 SV2 3.7-2M		4210	40	105	5040	36
ECO RAYS TP 0F3 STE-M 3.5-1M	STE-M	2380	21.5	110	2701	17
ECO RAYS TP 0F3 STE-M 3.5-2M		4510	39	115	5402	34
ECO RAYS TP 0F3 STE-M 3.7-1M	STE-M	2860	28	102	3420	24
ECO RAYS TP 0F3 STE-M 3.7-2M		5710	52	109	6840	48
ECO RAYS TP 0F3 STE-S 3.5-1M	STE-S	2380	21.5	110	2701	17
ECO RAYS TP 0F3 STE-S 3.5-2M		4510	39	115	5402	34
ECO RAYS TP 0F3 STE-S 3.7-1M	STE-S	2860	28	102	3420	24
ECO RAYS TP 0F3 STE-S 3.7-2M		5710	52	109	6840	48
ECO RAYS TP 0F3 STW 3.5-1M	STW	2380	21.5	110	2701	17
ECO RAYS TP 0F3 STW 3.5-2M		4510	39	115	5402	34
ECO RAYS TP 0F3 STW 3.7-1M	STW	2860	28	102	3420	24
ECO RAYS TP 0F3 STW 3.7-2M		5710	52	109	6840	48

*FLUSSO APPARECCHIO / POTENZA APPARECCHIO: Dati nominali rilevati in laboratorio.

*FLUSSO NOMINALE LED / POTENZA NOMINALE LED: Dati nominali estrapolati da datasheet costruttore LED.

I valori indicati in questa scheda tecnica sono da considerarsi valori nominali. Tolleranza su flusso: +/-7%. Tolleranza su potenza: +/-5%.

Tolleranza su potenza in versioni ZHAGA o con alimentatore D4i/SR: +/-10%.

Al fine di favorire un costante aggiornamento dei propri prodotti, AEC si riserva il diritto di apportare modifiche senza preavviso.



DICHIARAZIONE DI CONFORMITÀ



AEC ILLUMINAZIONE S.r.l.



Il seguente costruttore

Costruttore: **AEC ILLUMINAZIONE S.r.l.**

Indirizzo: Via A. Righi, 4 - Zona industriale Castelnuovo
52010 Subbiano (AR) - Italia

dichiara qui di seguito che il prodotto

ECO RAYS TP 0F2H1 S05 3.5-1M

apparecchio di illuminazione per l'installazione fissa

presenta caratteristiche fotometriche conformi a quanto previsto dalla seguente legge

Regione Veneto - Legge Regionale n° 17 del 7 agosto 2009

Subbiano, 10/11/2022

AEC ILLUMINAZIONE S.r.l.



DICHIARAZIONE DI CONFORMITÀ



AEC ILLUMINAZIONE S.r.l.



Il seguente costruttore

Costruttore: **AEC ILLUMINAZIONE S.r.l.**

Indirizzo: Via A. Righi, 4 - Zona industriale Castelnuovo
52010 Subbiano (AR) - Italia

dichiara qui di seguito che il prodotto

ECO RAYS TP 0F2H1 STU-S 3.5-1M

apparecchio di illuminazione per l'installazione fissa

presenta caratteristiche fotometriche conformi a quanto previsto dalla seguente legge

Regione Veneto - Legge Regionale n° 17 del 7 agosto 2009



Subbiano, 03/05/2022

AEC ILLUMINAZIONE S.r.l.

Costruttore	AEC ILLUMINAZIONE SRL
Tipo di prodotto	Outdoor Lighting Luminaire
Codice fotometria	ECO RAYS TP 0F2H1 S05 3.5-1M
Codice apparecchio	ECO RAYS TP 0F2H1 S05 3.5-1M
Rilievo fotometrico	18-009_0318
Descrizione apparecchio	ECO RAYS TP 0F2H1 S05 3.5-1M
Data emissione	03-04-2020

Foto del prodotto



Responsabile laboratorio fotometrico	Alessio Vagheggi	
Tecnico laboratorio che ha eseguito la misura	Tiziano Nicchi	

Sommario e Allegati

Sommario	Dati apparecchio	
	Normative di riferimento	
	Procedure di riferimento	
	Condizioni di prova	
	Risultati fotometrici	
	Lista strumentazione	
	Incertezza strumentale	
Allegati	Dati Generali	X
	Tabella fotometrica delle Intensità (cd/Klm)	X
	Tabella fotometrica delle Intensità (cd)	
	Diagramma Polare	
	Diagramma Cartesiano	
	Valutazione UGR	
	Diagramma Sollner Abbagliamento	
	Flusso Zonale	
	Coefficienti di Utilizzazione	
	Isolux Unitario	
	Isocandele Percentuale	
	Tabella e Diagramma Luminanza	
	Classificazione Strade	X
Classificazione Strade IES TM-15		

DATI APPARECCHIO

Geometria apparecchio	Circolare		
Dimensioni apparecchio (mm)	Lunghezza / Diametro	Larghezza	Altezza
	497	497	665
Dimensioni area luminosa (mm)	Lunghezza / Diametro	Larghezza	Altezza C0
	60	110	0
	Altezza C90	Altezza C180	Altezza C270
	0	0	0
Tipo sorgente	LED		
Modello sorgente	Luxeon-Mx/Luxeon-Tx		
Tipo Alimentatore	Elettronico / Electronic		
Modello Alimentatore	Philips Xi		

NORMATIVE DI RIFERIMENTO

Normative di riferimento	UNI EN 13032-1:2012 UNI EN 13032-4:2015
Valutazione luce parassita	In accordo con Annex A UNI EN 13032-1

PROCEDURE DI RIFERIMENTO

Procedure di riferimento	I-QL-009
---------------------------------	----------

CONDIZIONI DI PROVA

Laboratorio fotometrico	Interno AEC ILLUMINAZIONE srl, in regime di sistema di qualità aziendale certificato ISO 9001:2008, autorizzato UL	
Condizioni Ambientali	Temperatura ambiente (°C)	25±1
	Umidità relativa (°RH)	< 60
	Movimento aria (m/s)	< 0.2
Condizioni Elettriche	Tensione di alimentazione (V)	230
	Frequenza di alimentazione (Hz)	50
	Distorsione armonica THD V (%)	< 0.5%
Condizioni Preliminari Prova	Metodo di misura	Goniofotometro
	Sistema di riferimento misura	Sistema C-γ (Gonio)
	Posizione di misura	Verticale (Gonio)
	Distanza di misura (m)	9.03
	Tempo di stabilizzazione (min)	> 60
	Instabilità sorgente (%)	< 0.5%

I risultati delle verifiche e prove qui riportati, si riferiscono esclusivamente agli esemplari esaminati e descritti nella presente Relazione. L'estensione del riferimento ad esemplari che non siano quelli sottoposti alle verifiche descritte in seguito esula dallo scopo delle verifiche stesse. E' vietata la riproduzione integrale o parziale senza l'autorizzazione scritta di Aec illuminazione srl. L'immagine dell'apparecchio nella prima pagina è puramente indicativa della tipologia di apparecchio sottoposto a test.

RISULTATI FOTOMETRICI

Tipo di misura fotometrica	Assoluta
LOR (%)	100.0
Flusso luminoso apparecchio (lm)	1700
Potenza ingresso apparecchio (W)	16.0
Efficienza apparecchio (lm/W)	106
Note e commenti	

LISTA STRUMENTAZIONE

CODICE AEC	STRUMENTO	COSTRUTTORE	MODELLO
Q129	Luxmetro	Czibula&Grundmann	100310
Q130	Goniofotometro	Oxytech	T2
Q131	Termoigrometro	Delta Ohm	HD2001
Q132	Wattmetro	N4L	PPA2510
Q135	Stabilizzatore	Elettrotest	TPS/M/9KW
Q205	Luxmetro	Czibula&Grundmann	161206

INCERTEZZA STRUMENTALE

Encoder goniofotometro Oxytech T2	Precisione angolare in C – gamma	$\pm 0.044^\circ$
Luxmetro C&G	f1'	< 1.23%
Wattmetro Kinetiq N4L PPA2510	Accuratezza di potenza	< [0.05% + 0.03%/pf + (0.01%/kHz)/pf] Rdg + 0.05%VA Rng

Apparecchio		Rilievo		Lampada	
Codice	ECO RAYS TP 0F2H1 S05 3.5-1M	Codice	18-009_0318	Codice	L-ECR-0F2H1-3000-525-1M-70-25
Nome	ECO RAYS TP 0F2H1 S05 3.5-1M	Nome	ECO RAYS TP 0F2H1 S05 3.5-1M	Numero	1
Archivio	Eulumdat	Data	03-04-2020	Posizione	

Flusso Apparecchio	1700.00 lm	Potenza Apparecchio	16.00 W	Efficacia	106.25 lm/W	Rendimento	100.00%
Flusso Lampade	1700.00 lm	Valore Massimo	573.63 cd/klm	Posizione	C=45.00 G=59.00	CG	Asimmetrico
Apparecchio Circolare	Diam.	497 mm	Alt.	665 mm	Alt.	0 mm	
Area Luminosa Rettangolare	Lung.	60 mm	Larg.	110 mm			
Area Luminosa Orizzontale	0.006600 m2	Area Luminosa Piano 180°	0.000000 m2				
Area Luminosa Piano 0°	0.000000 m2	Area Luminosa Piano 270°	0.000000 m2				
Area Luminosa Piano 90°	0.000000 m2	Area Luminosa a 76°	0.001597 m2				
Sistema Coordinate	CG	Tipo di Simmetria	Asimmetrico				
Data	03-04-2020	Massimo Angolo Gamma	180				

Lampade Apparecchio					
Archivio	Codice	Nome	Flusso [lm]	Pot. [W]	Q.tà
	L-ECR-0F2H1-3000-525-1M-70-25	L-ECR-0F2H1-3000-525-1M-70-25 - 16.00 W	1700.00	16.00	1
C.I.E.	27 66 96 100 100	D DIN 5040	A10		
F UTE	1.00 I	B NBN	BZ 7 / 1 / BZ 6 / 2.5 / BZ 5		

Diam=497mm

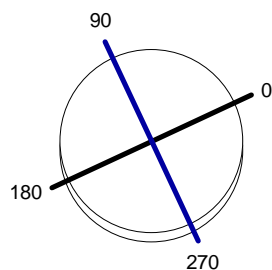

Semipiani C



ULOR	0.00 %
DLOR	100.00 %
RN	0.00 %

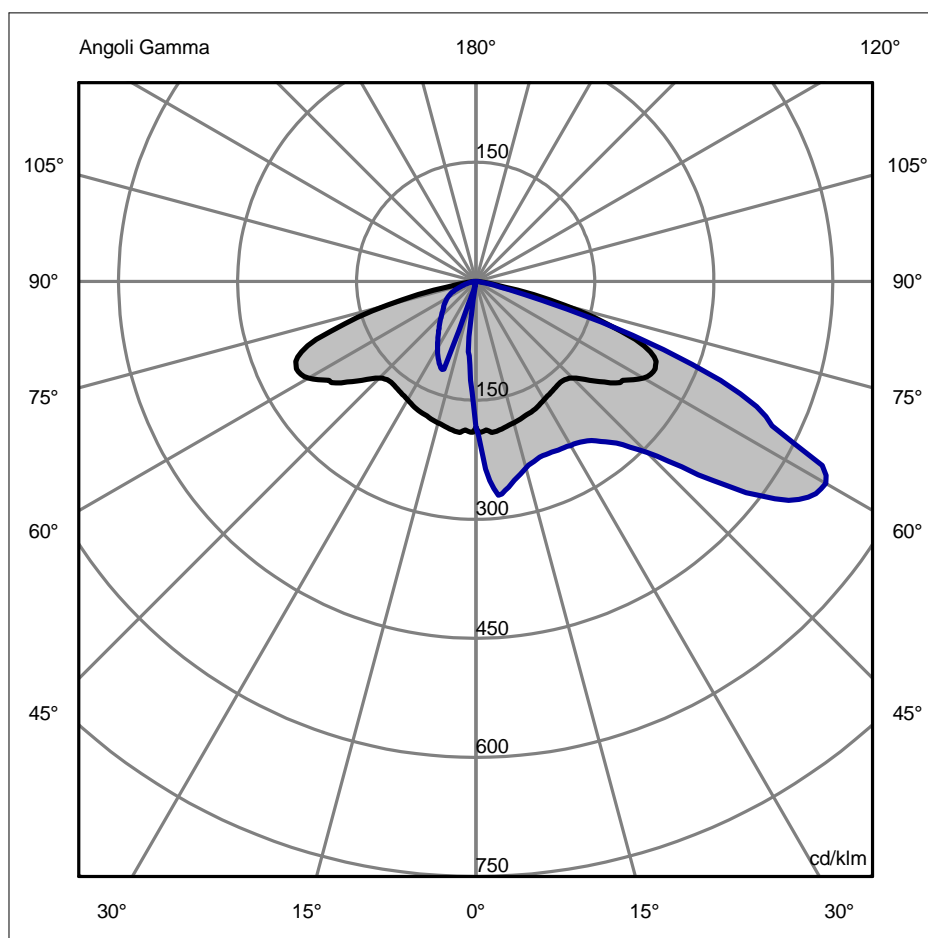

Apparecchio		Rilievo		Lampada	
Codice	ECO RAYS TP 0F2H1 S05 3.5-1M	Codice	18-009_0318	Codice	L-ECR-0F2H1-3000-525-1M-70-25
Nome	ECO RAYS TP 0F2H1 S05 3.5-1M	Nome	ECO RAYS TP 0F2H1 S05 3.5-1M	Numero	1
Archivio	Eulumdat	Data	03-04-2020	Posizione	

Flusso Apparecchio	1700.00 lm	Potenza Apparecchio	16.00 W	Efficacia	106.25 lm/W	Rendimento	100.00%
Flusso Lampade	1700.00 lm	Valore Massimo	573.63 cd/klm	Posizione	C=45.00 G=59.00	CG	Asimmetrico

Tabella Intensità Luminose - cd/klm Tabella 6/18

	C 325.00	C 330.00	C 335.00	C 340.00	C 345.00	C 350.00	C 355.00
G 0.0	183.83	183.83	183.83	183.83	183.83	183.83	183.83
G 1.0	173.66	178.10	178.96	182.56	184.49	187.61	189.12
G 2.0	160.69	165.38	168.76	174.10	178.54	183.91	187.21
G 3.0	148.81	153.55	159.16	165.03	171.43	178.75	184.45
G 4.0	140.68	144.72	150.12	156.84	164.50	174.03	182.23
G 5.0	121.69	136.95	143.75	151.34	160.67	172.12	182.85
G 6.0	115.07	125.75	137.54	146.01	155.23	168.12	181.17
G 7.0	115.95	119.40	130.21	139.51	149.59	162.71	178.08
G 8.0	117.18	116.87	123.31	133.46	144.73	157.98	175.58
G 9.0	118.47	118.17	118.76	128.51	140.48	154.16	172.89
G 10.0	120.06	119.51	118.18	123.92	136.78	151.08	170.53
G 11.0	122.12	120.80	119.23	120.11	132.99	148.18	168.13
G 12.0	123.60	122.29	119.95	118.28	129.15	145.17	165.25
G 13.0	124.44	123.19	120.32	118.50	125.02	141.85	162.70
G 14.0	124.46	123.47	120.98	118.81	121.12	138.77	159.83
G 15.0	123.91	123.43	121.28	119.02	118.05	135.21	156.99
G 16.0	121.17	123.08	121.76	119.43	116.16	131.44	154.06
G 17.0	117.06	122.61	122.05	119.66	115.58	127.30	150.94
G 18.0	110.36	122.33	122.46	119.77	115.12	123.26	147.64
G 19.0	108.97	121.90	122.66	119.89	114.71	118.97	144.57
G 20.0	108.16	121.57	122.80	119.83	114.28	115.02	141.64
G 21.0	107.45	118.35	122.81	119.86	113.99	111.79	139.06
G 22.0	106.57	117.02	122.76	119.79	113.82	109.37	136.74
G 23.0	105.49	112.57	122.49	119.76	113.63	107.75	134.58
G 24.0	104.18	110.54	122.20	119.71	113.54	106.61	132.54
G 25.0	102.39	109.78	121.74	119.68	113.48	106.03	130.44
G 26.0	99.94	108.96	121.31	119.75	113.23	105.74	128.38
G 27.0	96.83	108.30	120.82	119.80	113.12	105.65	126.02
G 28.0	92.92	107.41	120.28	119.76	113.02	105.61	123.89
G 29.0	87.72	106.60	118.21	119.72	113.02	105.76	122.06
G 30.0	81.85	105.54	116.60	119.61	113.03	105.84	119.88
G 31.0	75.11	104.46	115.76	119.49	113.19	105.99	117.69
G 32.0	67.42	103.18	111.59	119.33	113.23	106.16	115.52
G 33.0	60.03	101.75	110.91	119.01	113.20	106.27	113.37
G 34.0	52.54	100.22	110.17	118.84	113.30	106.34	111.41
G 35.0	48.30	98.14	109.31	118.42	113.27	106.50	109.62
G 36.0	41.52	96.42	108.45	117.87	113.31	106.67	108.06
G 37.0	37.05	93.94	107.40	117.32	113.28	106.85	106.62
G 38.0	35.53	91.12	106.31	116.63	113.38	107.22	105.54
G 39.0	32.20	87.84	105.00	115.79	113.38	107.52	104.85
G 40.0	29.49	84.12	103.93	114.91	113.36	107.88	104.60
G 41.0	27.78	80.05	102.54	113.95	113.38	108.26	104.77
G 42.0	26.49	75.71	101.07	112.86	113.51	109.04	105.31
G 43.0	25.96	71.05	99.48	111.43	113.46	109.81	106.54
G 44.0	25.73	66.21	97.78	110.14	113.62	110.73	108.26
G 45.0	25.75	61.58	95.83	108.64	113.67	111.69	110.51
G 46.0	25.96	57.14	93.56	106.88	113.54	112.91	113.08
G 47.0	26.29	52.54	90.97	104.44	113.22	114.16	116.21
G 48.0	27.04	48.28	88.09	102.37	112.68	115.29	119.94
G 49.0	27.77	44.74	84.83	99.97	111.98	116.69	123.68
G 50.0	28.34	40.95	81.05	97.00	111.19	117.91	127.64
G 51.0	29.08	37.90	77.29	93.86	110.26	119.20	131.26
G 52.0	30.05	34.36	72.82	90.52	108.78	120.32	134.91
G 53.0	30.82	32.04	68.25	86.85	107.28	120.98	137.88
G 54.0	31.38	29.71	63.31	83.04	105.08	121.36	140.51
G 55.0	32.05	27.11	58.67	79.34	102.73	121.06	142.49
G 56.0	32.88	25.37	53.77	75.75	99.55	120.11	143.86
G 57.0	33.62	23.86	49.27	72.05	96.04	118.87	145.08
G 58.0	34.10	22.55	45.06	68.80	91.99	116.90	146.21
G 59.0	34.37	21.49	41.26	64.92	87.26	114.97	147.68
G 60.0	34.66	20.44	37.52	62.40	83.03	112.41	149.88
G 61.0	34.93	19.66	33.90	59.20	78.13	110.57	153.03
G 62.0	35.21	19.00	30.86	56.25	73.60	108.72	157.43
G 63.0	35.80	18.41	27.96	53.54	69.70	107.30	161.85
G 64.0	36.32	18.09	25.53	50.68	65.10	106.08	165.95
G 65.0	36.82	17.99	23.13	48.07	61.12	104.94	169.29
G 66.0	37.35	17.94	21.10	45.60	57.14	103.17	170.49
G 67.0	37.66	17.90	18.99	42.90	53.51	100.69	169.40
G 68.0	37.76	17.90	17.13	40.16	49.57	96.36	166.14
G 69.0	37.55	17.93	15.31	37.60	46.05	90.99	160.56
G 70.0	36.88	17.93	13.66	34.98	42.69	84.87	152.50
G 71.0	35.83	17.83	12.07	32.11	39.05	77.75	144.52
G 72.0	34.36	17.59	10.59	29.52	35.95	69.56	132.88

Apparecchio		Rilievo		Lampada	
Codice	ECO RAYS TP 0F2H1 S05 3.5-1M	Codice	18-009_0318	Codice	L-ECR-0F2H1-3000-525-1M-70-25
Nome	ECO RAYS TP 0F2H1 S05 3.5-1M	Nome	ECO RAYS TP 0F2H1 S05 3.5-1M	Numero	1
Archivio	Eulumdat	Data	03-04-2020	Posizione	

Flusso Apparecchio	1700.00 lm	Potenza Apparecchio	16.00 W	Efficacia	106.25 lm/W	Rendimento	100.00%
Flusso Lampade	1700.00 lm	Valore Massimo	573.63 cd/klm	Posizione	C=45.00 G=59.00	CG	Asimmetrico

Tabella Intensità Luminosa - cd/klm Tabella 12/18

	C 325.00	C 330.00	C 335.00	C 340.00	C 345.00	C 350.00	C 355.00
G 73.0	32.59	17.21	9.24	26.37	32.88	60.58	120.61
G 74.0	30.13	16.65	8.13	23.55	29.99	52.11	106.92
G 75.0	26.42	15.86	7.07	20.56	27.31	44.14	94.10
G 76.0	22.79	14.49	6.11	17.59	24.35	35.71	78.07
G 77.0	18.87	12.61	5.32	14.96	21.26	27.31	57.16
G 78.0	15.66	10.57	4.54	12.26	17.91	21.43	39.48
G 79.0	12.86	8.70	3.91	9.96	14.95	16.76	26.50
G 80.0	10.34	7.18	3.26	7.81	12.17	13.38	19.18
G 81.0	7.98	5.74	2.74	6.05	9.70	10.88	13.35
G 82.0	5.74	4.37	2.24	4.61	7.41	8.59	10.00
G 83.0	3.98	3.19	1.82	3.47	5.50	6.61	7.55
G 84.0	2.84	2.20	1.42	2.56	4.06	4.80	5.32
G 85.0	2.09	1.52	1.09	1.88	2.74	3.29	3.54
G 86.0	1.43	1.05	0.81	1.32	1.81	2.04	2.21
G 87.0	0.94	0.68	0.59	0.91	1.10	1.23	1.17
G 88.0	0.56	0.46	0.46	0.60	0.67	0.71	0.59
G 89.0	0.34	0.36	0.39	0.42	0.43	0.39	0.34
G 90.0	0.00	0.00	0.00	0.00	0.00	0.00	0.00
G 91.0	0.00	0.00	0.00	0.00	0.00	0.00	0.00
G 92.0	0.00	0.00	0.00	0.00	0.00	0.00	0.00
G 93.0	0.00	0.00	0.00	0.00	0.00	0.00	0.00
G 94.0	0.00	0.00	0.00	0.00	0.00	0.00	0.00
G 95.0	0.00	0.00	0.00	0.00	0.00	0.00	0.00
G 96.0	0.00	0.00	0.00	0.00	0.00	0.00	0.00
G 97.0	0.00	0.00	0.00	0.00	0.00	0.00	0.00
G 98.0	0.00	0.00	0.00	0.00	0.00	0.00	0.00
G 99.0	0.00	0.00	0.00	0.00	0.00	0.00	0.00
G100.0	0.00	0.00	0.00	0.00	0.00	0.00	0.00
G101.0	0.00	0.00	0.00	0.00	0.00	0.00	0.00
G102.0	0.00	0.00	0.00	0.00	0.00	0.00	0.00
G103.0	0.00	0.00	0.00	0.00	0.00	0.00	0.00
G104.0	0.00	0.00	0.00	0.00	0.00	0.00	0.00
G105.0	0.00	0.00	0.00	0.00	0.00	0.00	0.00
G106.0	0.00	0.00	0.00	0.00	0.00	0.00	0.00
G107.0	0.00	0.00	0.00	0.00	0.00	0.00	0.00
G108.0	0.00	0.00	0.00	0.00	0.00	0.00	0.00
G109.0	0.00	0.00	0.00	0.00	0.00	0.00	0.00
G110.0	0.00	0.00	0.00	0.00	0.00	0.00	0.00
G111.0	0.00	0.00	0.00	0.00	0.00	0.00	0.00
G112.0	0.00	0.00	0.00	0.00	0.00	0.00	0.00
G113.0	0.00	0.00	0.00	0.00	0.00	0.00	0.00
G114.0	0.00	0.00	0.00	0.00	0.00	0.00	0.00
G115.0	0.00	0.00	0.00	0.00	0.00	0.00	0.00
G116.0	0.00	0.00	0.00	0.00	0.00	0.00	0.00
G117.0	0.00	0.00	0.00	0.00	0.00	0.00	0.00
G118.0	0.00	0.00	0.00	0.00	0.00	0.00	0.00
G119.0	0.00	0.00	0.00	0.00	0.00	0.00	0.00
G120.0	0.00	0.00	0.00	0.00	0.00	0.00	0.00
G121.0	0.00	0.00	0.00	0.00	0.00	0.00	0.00
G122.0	0.00	0.00	0.00	0.00	0.00	0.00	0.00
G123.0	0.00	0.00	0.00	0.00	0.00	0.00	0.00
G124.0	0.00	0.00	0.00	0.00	0.00	0.00	0.00
G125.0	0.00	0.00	0.00	0.00	0.00	0.00	0.00
G126.0	0.00	0.00	0.00	0.00	0.00	0.00	0.00
G127.0	0.00	0.00	0.00	0.00	0.00	0.00	0.00
G128.0	0.00	0.00	0.00	0.00	0.00	0.00	0.00
G129.0	0.00	0.00	0.00	0.00	0.00	0.00	0.00
G130.0	0.00	0.00	0.00	0.00	0.00	0.00	0.00
G131.0	0.00	0.00	0.00	0.00	0.00	0.00	0.00
G132.0	0.00	0.00	0.00	0.00	0.00	0.00	0.00
G133.0	0.00	0.00	0.00	0.00	0.00	0.00	0.00
G134.0	0.00	0.00	0.00	0.00	0.00	0.00	0.00
G135.0	0.00	0.00	0.00	0.00	0.00	0.00	0.00
G136.0	0.00	0.00	0.00	0.00	0.00	0.00	0.00
G137.0	0.00	0.00	0.00	0.00	0.00	0.00	0.00
G138.0	0.00	0.00	0.00	0.00	0.00	0.00	0.00
G139.0	0.00	0.00	0.00	0.00	0.00	0.00	0.00
G140.0	0.00	0.00	0.00	0.00	0.00	0.00	0.00
G141.0	0.00	0.00	0.00	0.00	0.00	0.00	0.00
G142.0	0.00	0.00	0.00	0.00	0.00	0.00	0.00
G143.0	0.00	0.00	0.00	0.00	0.00	0.00	0.00
G144.0	0.00	0.00	0.00	0.00	0.00	0.00	0.00
G145.0	0.00	0.00	0.00	0.00	0.00	0.00	0.00

Apparecchio		Rilievo		Lampada	
Codice	ECO RAYS TP 0F2H1 S05 3.5-1M	Codice	18-009_0318	Codice	L-ECR-0F2H1-3000-525-1M-70-25
Nome	ECO RAYS TP 0F2H1 S05 3.5-1M	Nome	ECO RAYS TP 0F2H1 S05 3.5-1M	Numero	1
Archivio	Eulumdat	Data	03-04-2020	Posizione	

Flusso Apparecchio	1700.00 lm	Potenza Apparecchio	16.00 W	Efficacia	106.25 lm/W	Rendimento	100.00%
Flusso Lampade	1700.00 lm	Valore Massimo	573.63 cd/klm	Posizione	C=45.00 G=59.00	CG	Asimmetrico

Tabella Intensità Luminosa - cd/klm Tabella 13/18

	C 0.00	C 5.00	C 10.00	C 15.00	C 20.00	C 25.00	C 30.00	C 35.00	C 40.00	C 45.00	C 50.00	C 55.00	C 60.00
G146.0	0.00	0.00	0.00	0.00	0.00	0.00	0.00	0.00	0.00	0.00	0.00	0.00	0.00
G147.0	0.00	0.00	0.00	0.00	0.00	0.00	0.00	0.00	0.00	0.00	0.00	0.00	0.00
G148.0	0.00	0.00	0.00	0.00	0.00	0.00	0.00	0.00	0.00	0.00	0.00	0.00	0.00
G149.0	0.00	0.00	0.00	0.00	0.00	0.00	0.00	0.00	0.00	0.00	0.00	0.00	0.00
G150.0	0.00	0.00	0.00	0.00	0.00	0.00	0.00	0.00	0.00	0.00	0.00	0.00	0.00
G151.0	0.00	0.00	0.00	0.00	0.00	0.00	0.00	0.00	0.00	0.00	0.00	0.00	0.00
G152.0	0.00	0.00	0.00	0.00	0.00	0.00	0.00	0.00	0.00	0.00	0.00	0.00	0.00
G153.0	0.00	0.00	0.00	0.00	0.00	0.00	0.00	0.00	0.00	0.00	0.00	0.00	0.00
G154.0	0.00	0.00	0.00	0.00	0.00	0.00	0.00	0.00	0.00	0.00	0.00	0.00	0.00
G155.0	0.00	0.00	0.00	0.00	0.00	0.00	0.00	0.00	0.00	0.00	0.00	0.00	0.00
G156.0	0.00	0.00	0.00	0.00	0.00	0.00	0.00	0.00	0.00	0.00	0.00	0.00	0.00
G157.0	0.00	0.00	0.00	0.00	0.00	0.00	0.00	0.00	0.00	0.00	0.00	0.00	0.00
G158.0	0.00	0.00	0.00	0.00	0.00	0.00	0.00	0.00	0.00	0.00	0.00	0.00	0.00
G159.0	0.00	0.00	0.00	0.00	0.00	0.00	0.00	0.00	0.00	0.00	0.00	0.00	0.00
G160.0	0.00	0.00	0.00	0.00	0.00	0.00	0.00	0.00	0.00	0.00	0.00	0.00	0.00
G161.0	0.00	0.00	0.00	0.00	0.00	0.00	0.00	0.00	0.00	0.00	0.00	0.00	0.00
G162.0	0.00	0.00	0.00	0.00	0.00	0.00	0.00	0.00	0.00	0.00	0.00	0.00	0.00
G163.0	0.00	0.00	0.00	0.00	0.00	0.00	0.00	0.00	0.00	0.00	0.00	0.00	0.00
G164.0	0.00	0.00	0.00	0.00	0.00	0.00	0.00	0.00	0.00	0.00	0.00	0.00	0.00
G165.0	0.00	0.00	0.00	0.00	0.00	0.00	0.00	0.00	0.00	0.00	0.00	0.00	0.00
G166.0	0.00	0.00	0.00	0.00	0.00	0.00	0.00	0.00	0.00	0.00	0.00	0.00	0.00
G167.0	0.00	0.00	0.00	0.00	0.00	0.00	0.00	0.00	0.00	0.00	0.00	0.00	0.00
G168.0	0.00	0.00	0.00	0.00	0.00	0.00	0.00	0.00	0.00	0.00	0.00	0.00	0.00
G169.0	0.00	0.00	0.00	0.00	0.00	0.00	0.00	0.00	0.00	0.00	0.00	0.00	0.00
G170.0	0.00	0.00	0.00	0.00	0.00	0.00	0.00	0.00	0.00	0.00	0.00	0.00	0.00
G171.0	0.00	0.00	0.00	0.00	0.00	0.00	0.00	0.00	0.00	0.00	0.00	0.00	0.00
G172.0	0.00	0.00	0.00	0.00	0.00	0.00	0.00	0.00	0.00	0.00	0.00	0.00	0.00
G173.0	0.00	0.00	0.00	0.00	0.00	0.00	0.00	0.00	0.00	0.00	0.00	0.00	0.00
G174.0	0.00	0.00	0.00	0.00	0.00	0.00	0.00	0.00	0.00	0.00	0.00	0.00	0.00
G175.0	0.00	0.00	0.00	0.00	0.00	0.00	0.00	0.00	0.00	0.00	0.00	0.00	0.00
G176.0	0.00	0.00	0.00	0.00	0.00	0.00	0.00	0.00	0.00	0.00	0.00	0.00	0.00
G177.0	0.00	0.00	0.00	0.00	0.00	0.00	0.00	0.00	0.00	0.00	0.00	0.00	0.00
G178.0	0.00	0.00	0.00	0.00	0.00	0.00	0.00	0.00	0.00	0.00	0.00	0.00	0.00
G179.0	0.00	0.00	0.00	0.00	0.00	0.00	0.00	0.00	0.00	0.00	0.00	0.00	0.00
G180.0	0.00	0.00	0.00	0.00	0.00	0.00	0.00	0.00	0.00	0.00	0.00	0.00	0.00

Apparecchio		Rilievo		Lampada	
Codice	ECO RAYS TP 0F2H1 S05 3.5-1M	Codice	18-009_0318	Codice	L-ECR-0F2H1-3000-525-1M-70-25
Nome	ECO RAYS TP 0F2H1 S05 3.5-1M	Nome	ECO RAYS TP 0F2H1 S05 3.5-1M	Numero	1
Archivio	Eulumdat	Data	03-04-2020	Posizione	

Flusso Apparecchio	1700.00 lm	Potenza Apparecchio	16.00 W	Efficacia	106.25 lm/W	Rendimento	100.00%
Flusso Lampade	1700.00 lm	Valore Massimo	573.63 cd/klm	Posizione	C=45.00 G=59.00	CG	Asimmetrico

Tabella Intensità Luminose - cd/klm Tabella 14/18

	C 65.00	C 70.00	C 75.00	C 80.00	C 85.00	C 90.00	C 95.00	C 100.00	C 105.00	C 110.00	C 115.00	C 120.00	C 125.00
G146.0	0.00	0.00	0.00	0.00	0.00	0.00	0.00	0.00	0.00	0.00	0.00	0.00	0.00
G147.0	0.00	0.00	0.00	0.00	0.00	0.00	0.00	0.00	0.00	0.00	0.00	0.00	0.00
G148.0	0.00	0.00	0.00	0.00	0.00	0.00	0.00	0.00	0.00	0.00	0.00	0.00	0.00
G149.0	0.00	0.00	0.00	0.00	0.00	0.00	0.00	0.00	0.00	0.00	0.00	0.00	0.00
G150.0	0.00	0.00	0.00	0.00	0.00	0.00	0.00	0.00	0.00	0.00	0.00	0.00	0.00
G151.0	0.00	0.00	0.00	0.00	0.00	0.00	0.00	0.00	0.00	0.00	0.00	0.00	0.00
G152.0	0.00	0.00	0.00	0.00	0.00	0.00	0.00	0.00	0.00	0.00	0.00	0.00	0.00
G153.0	0.00	0.00	0.00	0.00	0.00	0.00	0.00	0.00	0.00	0.00	0.00	0.00	0.00
G154.0	0.00	0.00	0.00	0.00	0.00	0.00	0.00	0.00	0.00	0.00	0.00	0.00	0.00
G155.0	0.00	0.00	0.00	0.00	0.00	0.00	0.00	0.00	0.00	0.00	0.00	0.00	0.00
G156.0	0.00	0.00	0.00	0.00	0.00	0.00	0.00	0.00	0.00	0.00	0.00	0.00	0.00
G157.0	0.00	0.00	0.00	0.00	0.00	0.00	0.00	0.00	0.00	0.00	0.00	0.00	0.00
G158.0	0.00	0.00	0.00	0.00	0.00	0.00	0.00	0.00	0.00	0.00	0.00	0.00	0.00
G159.0	0.00	0.00	0.00	0.00	0.00	0.00	0.00	0.00	0.00	0.00	0.00	0.00	0.00
G160.0	0.00	0.00	0.00	0.00	0.00	0.00	0.00	0.00	0.00	0.00	0.00	0.00	0.00
G161.0	0.00	0.00	0.00	0.00	0.00	0.00	0.00	0.00	0.00	0.00	0.00	0.00	0.00
G162.0	0.00	0.00	0.00	0.00	0.00	0.00	0.00	0.00	0.00	0.00	0.00	0.00	0.00
G163.0	0.00	0.00	0.00	0.00	0.00	0.00	0.00	0.00	0.00	0.00	0.00	0.00	0.00
G164.0	0.00	0.00	0.00	0.00	0.00	0.00	0.00	0.00	0.00	0.00	0.00	0.00	0.00
G165.0	0.00	0.00	0.00	0.00	0.00	0.00	0.00	0.00	0.00	0.00	0.00	0.00	0.00
G166.0	0.00	0.00	0.00	0.00	0.00	0.00	0.00	0.00	0.00	0.00	0.00	0.00	0.00
G167.0	0.00	0.00	0.00	0.00	0.00	0.00	0.00	0.00	0.00	0.00	0.00	0.00	0.00
G168.0	0.00	0.00	0.00	0.00	0.00	0.00	0.00	0.00	0.00	0.00	0.00	0.00	0.00
G169.0	0.00	0.00	0.00	0.00	0.00	0.00	0.00	0.00	0.00	0.00	0.00	0.00	0.00
G170.0	0.00	0.00	0.00	0.00	0.00	0.00	0.00	0.00	0.00	0.00	0.00	0.00	0.00
G171.0	0.00	0.00	0.00	0.00	0.00	0.00	0.00	0.00	0.00	0.00	0.00	0.00	0.00
G172.0	0.00	0.00	0.00	0.00	0.00	0.00	0.00	0.00	0.00	0.00	0.00	0.00	0.00
G173.0	0.00	0.00	0.00	0.00	0.00	0.00	0.00	0.00	0.00	0.00	0.00	0.00	0.00
G174.0	0.00	0.00	0.00	0.00	0.00	0.00	0.00	0.00	0.00	0.00	0.00	0.00	0.00
G175.0	0.00	0.00	0.00	0.00	0.00	0.00	0.00	0.00	0.00	0.00	0.00	0.00	0.00
G176.0	0.00	0.00	0.00	0.00	0.00	0.00	0.00	0.00	0.00	0.00	0.00	0.00	0.00
G177.0	0.00	0.00	0.00	0.00	0.00	0.00	0.00	0.00	0.00	0.00	0.00	0.00	0.00
G178.0	0.00	0.00	0.00	0.00	0.00	0.00	0.00	0.00	0.00	0.00	0.00	0.00	0.00
G179.0	0.00	0.00	0.00	0.00	0.00	0.00	0.00	0.00	0.00	0.00	0.00	0.00	0.00
G180.0	0.00	0.00	0.00	0.00	0.00	0.00	0.00	0.00	0.00	0.00	0.00	0.00	0.00

Apparecchio		Rilievo		Lampada	
Codice	ECO RAYS TP 0F2H1 S05 3.5-1M	Codice	18-009_0318	Codice	L-ECR-0F2H1-3000-525-1M-70-25
Nome	ECO RAYS TP 0F2H1 S05 3.5-1M	Nome	ECO RAYS TP 0F2H1 S05 3.5-1M	Numero	1
Archivio	Eulumdat	Data	03-04-2020	Posizione	

Flusso Apparecchio	1700.00 lm	Potenza Apparecchio	16.00 W	Efficacia	106.25 lm/W	Rendimento	100.00%
Flusso Lampade	1700.00 lm	Valore Massimo	573.63 cd/klm	Posizione	C=45.00 G=59.00	CG	Asimmetrico

Tabella Intensità Luminose - cd/klm Tabella 15/18

	C 130.00	C 135.00	C 140.00	C 145.00	C 150.00	C 155.00	C 160.00	C 165.00	C 170.00	C 175.00	C 180.00	C 185.00	C 190.00
G146.0	0.00	0.00	0.00	0.00	0.00	0.00	0.00	0.00	0.00	0.00	0.00	0.00	0.00
G147.0	0.00	0.00	0.00	0.00	0.00	0.00	0.00	0.00	0.00	0.00	0.00	0.00	0.00
G148.0	0.00	0.00	0.00	0.00	0.00	0.00	0.00	0.00	0.00	0.00	0.00	0.00	0.00
G149.0	0.00	0.00	0.00	0.00	0.00	0.00	0.00	0.00	0.00	0.00	0.00	0.00	0.00
G150.0	0.00	0.00	0.00	0.00	0.00	0.00	0.00	0.00	0.00	0.00	0.00	0.00	0.00
G151.0	0.00	0.00	0.00	0.00	0.00	0.00	0.00	0.00	0.00	0.00	0.00	0.00	0.00
G152.0	0.00	0.00	0.00	0.00	0.00	0.00	0.00	0.00	0.00	0.00	0.00	0.00	0.00
G153.0	0.00	0.00	0.00	0.00	0.00	0.00	0.00	0.00	0.00	0.00	0.00	0.00	0.00
G154.0	0.00	0.00	0.00	0.00	0.00	0.00	0.00	0.00	0.00	0.00	0.00	0.00	0.00
G155.0	0.00	0.00	0.00	0.00	0.00	0.00	0.00	0.00	0.00	0.00	0.00	0.00	0.00
G156.0	0.00	0.00	0.00	0.00	0.00	0.00	0.00	0.00	0.00	0.00	0.00	0.00	0.00
G157.0	0.00	0.00	0.00	0.00	0.00	0.00	0.00	0.00	0.00	0.00	0.00	0.00	0.00
G158.0	0.00	0.00	0.00	0.00	0.00	0.00	0.00	0.00	0.00	0.00	0.00	0.00	0.00
G159.0	0.00	0.00	0.00	0.00	0.00	0.00	0.00	0.00	0.00	0.00	0.00	0.00	0.00
G160.0	0.00	0.00	0.00	0.00	0.00	0.00	0.00	0.00	0.00	0.00	0.00	0.00	0.00
G161.0	0.00	0.00	0.00	0.00	0.00	0.00	0.00	0.00	0.00	0.00	0.00	0.00	0.00
G162.0	0.00	0.00	0.00	0.00	0.00	0.00	0.00	0.00	0.00	0.00	0.00	0.00	0.00
G163.0	0.00	0.00	0.00	0.00	0.00	0.00	0.00	0.00	0.00	0.00	0.00	0.00	0.00
G164.0	0.00	0.00	0.00	0.00	0.00	0.00	0.00	0.00	0.00	0.00	0.00	0.00	0.00
G165.0	0.00	0.00	0.00	0.00	0.00	0.00	0.00	0.00	0.00	0.00	0.00	0.00	0.00
G166.0	0.00	0.00	0.00	0.00	0.00	0.00	0.00	0.00	0.00	0.00	0.00	0.00	0.00
G167.0	0.00	0.00	0.00	0.00	0.00	0.00	0.00	0.00	0.00	0.00	0.00	0.00	0.00
G168.0	0.00	0.00	0.00	0.00	0.00	0.00	0.00	0.00	0.00	0.00	0.00	0.00	0.00
G169.0	0.00	0.00	0.00	0.00	0.00	0.00	0.00	0.00	0.00	0.00	0.00	0.00	0.00
G170.0	0.00	0.00	0.00	0.00	0.00	0.00	0.00	0.00	0.00	0.00	0.00	0.00	0.00
G171.0	0.00	0.00	0.00	0.00	0.00	0.00	0.00	0.00	0.00	0.00	0.00	0.00	0.00
G172.0	0.00	0.00	0.00	0.00	0.00	0.00	0.00	0.00	0.00	0.00	0.00	0.00	0.00
G173.0	0.00	0.00	0.00	0.00	0.00	0.00	0.00	0.00	0.00	0.00	0.00	0.00	0.00
G174.0	0.00	0.00	0.00	0.00	0.00	0.00	0.00	0.00	0.00	0.00	0.00	0.00	0.00
G175.0	0.00	0.00	0.00	0.00	0.00	0.00	0.00	0.00	0.00	0.00	0.00	0.00	0.00
G176.0	0.00	0.00	0.00	0.00	0.00	0.00	0.00	0.00	0.00	0.00	0.00	0.00	0.00
G177.0	0.00	0.00	0.00	0.00	0.00	0.00	0.00	0.00	0.00	0.00	0.00	0.00	0.00
G178.0	0.00	0.00	0.00	0.00	0.00	0.00	0.00	0.00	0.00	0.00	0.00	0.00	0.00
G179.0	0.00	0.00	0.00	0.00	0.00	0.00	0.00	0.00	0.00	0.00	0.00	0.00	0.00
G180.0	0.00	0.00	0.00	0.00	0.00	0.00	0.00	0.00	0.00	0.00	0.00	0.00	0.00

Apparecchio		Rilievo		Lampada	
Codice	ECO RAYS TP 0F2H1 S05 3.5-1M	Codice	18-009_0318	Codice	L-ECR-0F2H1-3000-525-1M-70-25
Nome	ECO RAYS TP 0F2H1 S05 3.5-1M	Nome	ECO RAYS TP 0F2H1 S05 3.5-1M	Numero	1
Archivio	Eulumdat	Data	03-04-2020	Posizione	

Flusso Apparecchio	1700.00 lm	Potenza Apparecchio	16.00 W	Efficacia	106.25 lm/W	Rendimento	100.00%
Flusso Lampade	1700.00 lm	Valore Massimo	573.63 cd/klm	Posizione	C=45.00 G=59.00	CG	Asimmetrico

Tabella Intensità Luminose - cd/klm Tabella 16/18

	C 195.00	C 200.00	C 205.00	C 210.00	C 215.00	C 220.00	C 225.00	C 230.00	C 235.00	C 240.00	C 245.00	C 250.00	C 255.00
G146.0	0.00	0.00	0.00	0.00	0.00	0.00	0.00	0.00	0.00	0.00	0.00	0.00	0.00
G147.0	0.00	0.00	0.00	0.00	0.00	0.00	0.00	0.00	0.00	0.00	0.00	0.00	0.00
G148.0	0.00	0.00	0.00	0.00	0.00	0.00	0.00	0.00	0.00	0.00	0.00	0.00	0.00
G149.0	0.00	0.00	0.00	0.00	0.00	0.00	0.00	0.00	0.00	0.00	0.00	0.00	0.00
G150.0	0.00	0.00	0.00	0.00	0.00	0.00	0.00	0.00	0.00	0.00	0.00	0.00	0.00
G151.0	0.00	0.00	0.00	0.00	0.00	0.00	0.00	0.00	0.00	0.00	0.00	0.00	0.00
G152.0	0.00	0.00	0.00	0.00	0.00	0.00	0.00	0.00	0.00	0.00	0.00	0.00	0.00
G153.0	0.00	0.00	0.00	0.00	0.00	0.00	0.00	0.00	0.00	0.00	0.00	0.00	0.00
G154.0	0.00	0.00	0.00	0.00	0.00	0.00	0.00	0.00	0.00	0.00	0.00	0.00	0.00
G155.0	0.00	0.00	0.00	0.00	0.00	0.00	0.00	0.00	0.00	0.00	0.00	0.00	0.00
G156.0	0.00	0.00	0.00	0.00	0.00	0.00	0.00	0.00	0.00	0.00	0.00	0.00	0.00
G157.0	0.00	0.00	0.00	0.00	0.00	0.00	0.00	0.00	0.00	0.00	0.00	0.00	0.00
G158.0	0.00	0.00	0.00	0.00	0.00	0.00	0.00	0.00	0.00	0.00	0.00	0.00	0.00
G159.0	0.00	0.00	0.00	0.00	0.00	0.00	0.00	0.00	0.00	0.00	0.00	0.00	0.00
G160.0	0.00	0.00	0.00	0.00	0.00	0.00	0.00	0.00	0.00	0.00	0.00	0.00	0.00
G161.0	0.00	0.00	0.00	0.00	0.00	0.00	0.00	0.00	0.00	0.00	0.00	0.00	0.00
G162.0	0.00	0.00	0.00	0.00	0.00	0.00	0.00	0.00	0.00	0.00	0.00	0.00	0.00
G163.0	0.00	0.00	0.00	0.00	0.00	0.00	0.00	0.00	0.00	0.00	0.00	0.00	0.00
G164.0	0.00	0.00	0.00	0.00	0.00	0.00	0.00	0.00	0.00	0.00	0.00	0.00	0.00
G165.0	0.00	0.00	0.00	0.00	0.00	0.00	0.00	0.00	0.00	0.00	0.00	0.00	0.00
G166.0	0.00	0.00	0.00	0.00	0.00	0.00	0.00	0.00	0.00	0.00	0.00	0.00	0.00
G167.0	0.00	0.00	0.00	0.00	0.00	0.00	0.00	0.00	0.00	0.00	0.00	0.00	0.00
G168.0	0.00	0.00	0.00	0.00	0.00	0.00	0.00	0.00	0.00	0.00	0.00	0.00	0.00
G169.0	0.00	0.00	0.00	0.00	0.00	0.00	0.00	0.00	0.00	0.00	0.00	0.00	0.00
G170.0	0.00	0.00	0.00	0.00	0.00	0.00	0.00	0.00	0.00	0.00	0.00	0.00	0.00
G171.0	0.00	0.00	0.00	0.00	0.00	0.00	0.00	0.00	0.00	0.00	0.00	0.00	0.00
G172.0	0.00	0.00	0.00	0.00	0.00	0.00	0.00	0.00	0.00	0.00	0.00	0.00	0.00
G173.0	0.00	0.00	0.00	0.00	0.00	0.00	0.00	0.00	0.00	0.00	0.00	0.00	0.00
G174.0	0.00	0.00	0.00	0.00	0.00	0.00	0.00	0.00	0.00	0.00	0.00	0.00	0.00
G175.0	0.00	0.00	0.00	0.00	0.00	0.00	0.00	0.00	0.00	0.00	0.00	0.00	0.00
G176.0	0.00	0.00	0.00	0.00	0.00	0.00	0.00	0.00	0.00	0.00	0.00	0.00	0.00
G177.0	0.00	0.00	0.00	0.00	0.00	0.00	0.00	0.00	0.00	0.00	0.00	0.00	0.00
G178.0	0.00	0.00	0.00	0.00	0.00	0.00	0.00	0.00	0.00	0.00	0.00	0.00	0.00
G179.0	0.00	0.00	0.00	0.00	0.00	0.00	0.00	0.00	0.00	0.00	0.00	0.00	0.00
G180.0	0.00	0.00	0.00	0.00	0.00	0.00	0.00	0.00	0.00	0.00	0.00	0.00	0.00

Apparecchio		Rilievo		Lampada	
Codice	ECO RAYS TP 0F2H1 S05 3.5-1M	Codice	18-009_0318	Codice	L-ECR-0F2H1-3000-525-1M-70-25
Nome	ECO RAYS TP 0F2H1 S05 3.5-1M	Nome	ECO RAYS TP 0F2H1 S05 3.5-1M	Numero	1
Archivio	Eulumdat	Data	03-04-2020	Posizione	

Flusso Apparecchio	1700.00 lm	Potenza Apparecchio	16.00 W	Efficacia	106.25 lm/W	Rendimento	100.00%
Flusso Lampade	1700.00 lm	Valore Massimo	573.63 cd/klm	Posizione	C=45.00 G=59.00	CG	Asimmetrico

Tabella Intensità Luminose - cd/klm Tabella 17/18

	C 260.00	C 265.00	C 270.00	C 275.00	C 280.00	C 285.00	C 290.00	C 295.00	C 300.00	C 305.00	C 310.00	C 315.00	C 320.00
G146.0	0.00	0.00	0.00	0.00	0.00	0.00	0.00	0.00	0.00	0.00	0.00	0.00	0.00
G147.0	0.00	0.00	0.00	0.00	0.00	0.00	0.00	0.00	0.00	0.00	0.00	0.00	0.00
G148.0	0.00	0.00	0.00	0.00	0.00	0.00	0.00	0.00	0.00	0.00	0.00	0.00	0.00
G149.0	0.00	0.00	0.00	0.00	0.00	0.00	0.00	0.00	0.00	0.00	0.00	0.00	0.00
G150.0	0.00	0.00	0.00	0.00	0.00	0.00	0.00	0.00	0.00	0.00	0.00	0.00	0.00
G151.0	0.00	0.00	0.00	0.00	0.00	0.00	0.00	0.00	0.00	0.00	0.00	0.00	0.00
G152.0	0.00	0.00	0.00	0.00	0.00	0.00	0.00	0.00	0.00	0.00	0.00	0.00	0.00
G153.0	0.00	0.00	0.00	0.00	0.00	0.00	0.00	0.00	0.00	0.00	0.00	0.00	0.00
G154.0	0.00	0.00	0.00	0.00	0.00	0.00	0.00	0.00	0.00	0.00	0.00	0.00	0.00
G155.0	0.00	0.00	0.00	0.00	0.00	0.00	0.00	0.00	0.00	0.00	0.00	0.00	0.00
G156.0	0.00	0.00	0.00	0.00	0.00	0.00	0.00	0.00	0.00	0.00	0.00	0.00	0.00
G157.0	0.00	0.00	0.00	0.00	0.00	0.00	0.00	0.00	0.00	0.00	0.00	0.00	0.00
G158.0	0.00	0.00	0.00	0.00	0.00	0.00	0.00	0.00	0.00	0.00	0.00	0.00	0.00
G159.0	0.00	0.00	0.00	0.00	0.00	0.00	0.00	0.00	0.00	0.00	0.00	0.00	0.00
G160.0	0.00	0.00	0.00	0.00	0.00	0.00	0.00	0.00	0.00	0.00	0.00	0.00	0.00
G161.0	0.00	0.00	0.00	0.00	0.00	0.00	0.00	0.00	0.00	0.00	0.00	0.00	0.00
G162.0	0.00	0.00	0.00	0.00	0.00	0.00	0.00	0.00	0.00	0.00	0.00	0.00	0.00
G163.0	0.00	0.00	0.00	0.00	0.00	0.00	0.00	0.00	0.00	0.00	0.00	0.00	0.00
G164.0	0.00	0.00	0.00	0.00	0.00	0.00	0.00	0.00	0.00	0.00	0.00	0.00	0.00
G165.0	0.00	0.00	0.00	0.00	0.00	0.00	0.00	0.00	0.00	0.00	0.00	0.00	0.00
G166.0	0.00	0.00	0.00	0.00	0.00	0.00	0.00	0.00	0.00	0.00	0.00	0.00	0.00
G167.0	0.00	0.00	0.00	0.00	0.00	0.00	0.00	0.00	0.00	0.00	0.00	0.00	0.00
G168.0	0.00	0.00	0.00	0.00	0.00	0.00	0.00	0.00	0.00	0.00	0.00	0.00	0.00
G169.0	0.00	0.00	0.00	0.00	0.00	0.00	0.00	0.00	0.00	0.00	0.00	0.00	0.00
G170.0	0.00	0.00	0.00	0.00	0.00	0.00	0.00	0.00	0.00	0.00	0.00	0.00	0.00
G171.0	0.00	0.00	0.00	0.00	0.00	0.00	0.00	0.00	0.00	0.00	0.00	0.00	0.00
G172.0	0.00	0.00	0.00	0.00	0.00	0.00	0.00	0.00	0.00	0.00	0.00	0.00	0.00
G173.0	0.00	0.00	0.00	0.00	0.00	0.00	0.00	0.00	0.00	0.00	0.00	0.00	0.00
G174.0	0.00	0.00	0.00	0.00	0.00	0.00	0.00	0.00	0.00	0.00	0.00	0.00	0.00
G175.0	0.00	0.00	0.00	0.00	0.00	0.00	0.00	0.00	0.00	0.00	0.00	0.00	0.00
G176.0	0.00	0.00	0.00	0.00	0.00	0.00	0.00	0.00	0.00	0.00	0.00	0.00	0.00
G177.0	0.00	0.00	0.00	0.00	0.00	0.00	0.00	0.00	0.00	0.00	0.00	0.00	0.00
G178.0	0.00	0.00	0.00	0.00	0.00	0.00	0.00	0.00	0.00	0.00	0.00	0.00	0.00
G179.0	0.00	0.00	0.00	0.00	0.00	0.00	0.00	0.00	0.00	0.00	0.00	0.00	0.00
G180.0	0.00	0.00	0.00	0.00	0.00	0.00	0.00	0.00	0.00	0.00	0.00	0.00	0.00

Apparecchio		Rilievo		Lampada	
Codice	ECO RAYS TP 0F2H1 S05 3.5-1M	Codice	18-009_0318	Codice	L-ECR-0F2H1-3000-525-1M-70-25
Nome	ECO RAYS TP 0F2H1 S05 3.5-1M	Nome	ECO RAYS TP 0F2H1 S05 3.5-1M	Numero	1
Archivio	Eulumdat	Data	03-04-2020	Posizione	

Flusso Apparecchio	1700.00 lm	Potenza Apparecchio	16.00 W	Efficacia	106.25 lm/W	Rendimento	100.00%
Flusso Lampade	1700.00 lm	Valore Massimo	573.63 cd/klm	Posizione	C=45.00 G=59.00	CG	Asimmetrico

Tabella Intensità Luminosa - cd/klm Tabella 18/18

	C 325.00	C 330.00	C 335.00	C 340.00	C 345.00	C 350.00	C 355.00
G146.0	0.00	0.00	0.00	0.00	0.00	0.00	0.00
G147.0	0.00	0.00	0.00	0.00	0.00	0.00	0.00
G148.0	0.00	0.00	0.00	0.00	0.00	0.00	0.00
G149.0	0.00	0.00	0.00	0.00	0.00	0.00	0.00
G150.0	0.00	0.00	0.00	0.00	0.00	0.00	0.00
G151.0	0.00	0.00	0.00	0.00	0.00	0.00	0.00
G152.0	0.00	0.00	0.00	0.00	0.00	0.00	0.00
G153.0	0.00	0.00	0.00	0.00	0.00	0.00	0.00
G154.0	0.00	0.00	0.00	0.00	0.00	0.00	0.00
G155.0	0.00	0.00	0.00	0.00	0.00	0.00	0.00
G156.0	0.00	0.00	0.00	0.00	0.00	0.00	0.00
G157.0	0.00	0.00	0.00	0.00	0.00	0.00	0.00
G158.0	0.00	0.00	0.00	0.00	0.00	0.00	0.00
G159.0	0.00	0.00	0.00	0.00	0.00	0.00	0.00
G160.0	0.00	0.00	0.00	0.00	0.00	0.00	0.00
G161.0	0.00	0.00	0.00	0.00	0.00	0.00	0.00
G162.0	0.00	0.00	0.00	0.00	0.00	0.00	0.00
G163.0	0.00	0.00	0.00	0.00	0.00	0.00	0.00
G164.0	0.00	0.00	0.00	0.00	0.00	0.00	0.00
G165.0	0.00	0.00	0.00	0.00	0.00	0.00	0.00
G166.0	0.00	0.00	0.00	0.00	0.00	0.00	0.00
G167.0	0.00	0.00	0.00	0.00	0.00	0.00	0.00
G168.0	0.00	0.00	0.00	0.00	0.00	0.00	0.00
G169.0	0.00	0.00	0.00	0.00	0.00	0.00	0.00
G170.0	0.00	0.00	0.00	0.00	0.00	0.00	0.00
G171.0	0.00	0.00	0.00	0.00	0.00	0.00	0.00
G172.0	0.00	0.00	0.00	0.00	0.00	0.00	0.00
G173.0	0.00	0.00	0.00	0.00	0.00	0.00	0.00
G174.0	0.00	0.00	0.00	0.00	0.00	0.00	0.00
G175.0	0.00	0.00	0.00	0.00	0.00	0.00	0.00
G176.0	0.00	0.00	0.00	0.00	0.00	0.00	0.00
G177.0	0.00	0.00	0.00	0.00	0.00	0.00	0.00
G178.0	0.00	0.00	0.00	0.00	0.00	0.00	0.00
G179.0	0.00	0.00	0.00	0.00	0.00	0.00	0.00
G180.0	0.00	0.00	0.00	0.00	0.00	0.00	0.00

Apparecchio		Rilievo		Lampada	
Codice	ECO RAYS TP 0F2H1 S05 3.5-1M	Codice	18-009_0318	Codice	L-ECR-0F2H1-3000-525-1M-70-25
Nome	ECO RAYS TP 0F2H1 S05 3.5-1M	Nome	ECO RAYS TP 0F2H1 S05 3.5-1M	Numero	1
Archivio	Eulumdat	Data	03-04-2020	Posizione	

Flusso Apparecchio	1700.00 lm	Potenza Apparecchio	16.00 W	Efficacia	106.25 lm/W	Rendimento	100.00%
Flusso Lampade	1700.00 lm	Valore Massimo	573.63 cd/klm	Posizione	C=45.00 G=59.00	CG	Asimmetrico

Marciapiede			Strada		
Piano	0	0.00%	Piano	0	0.00%
Piano	-5	2.54%	Piano	5	3.79%
Piano	-10	4.56%	Piano	10	8.26%
Piano	-15	6.27%	Piano	15	12.80%
Piano	-20	7.68%	Piano	20	17.48%
Piano	-25	9.15%	Piano	25	22.46%
Piano	-30	10.52%	Piano	30	27.87%
Piano	-35	11.72%	Piano	35	33.78%
Piano	-40	12.78%	Piano	40	40.24%
Piano	-45	13.74%	Piano	45	47.21%
Piano	-50	14.61%	Piano	50	54.63%
Piano	-55	15.42%	Piano	55	62.32%
Piano	-60	16.16%	Piano	60	69.73%
Piano	-65	16.79%	Piano	65	75.93%
Piano	-70	17.23%	Piano	70	80.07%
Piano	-75	17.49%	Piano	75	81.80%
Piano	-80	17.62%	Piano	80	82.19%
Piano	-85	17.67%	Piano	85	82.29%
Piano	-90	17.69%	Piano	90	82.31%

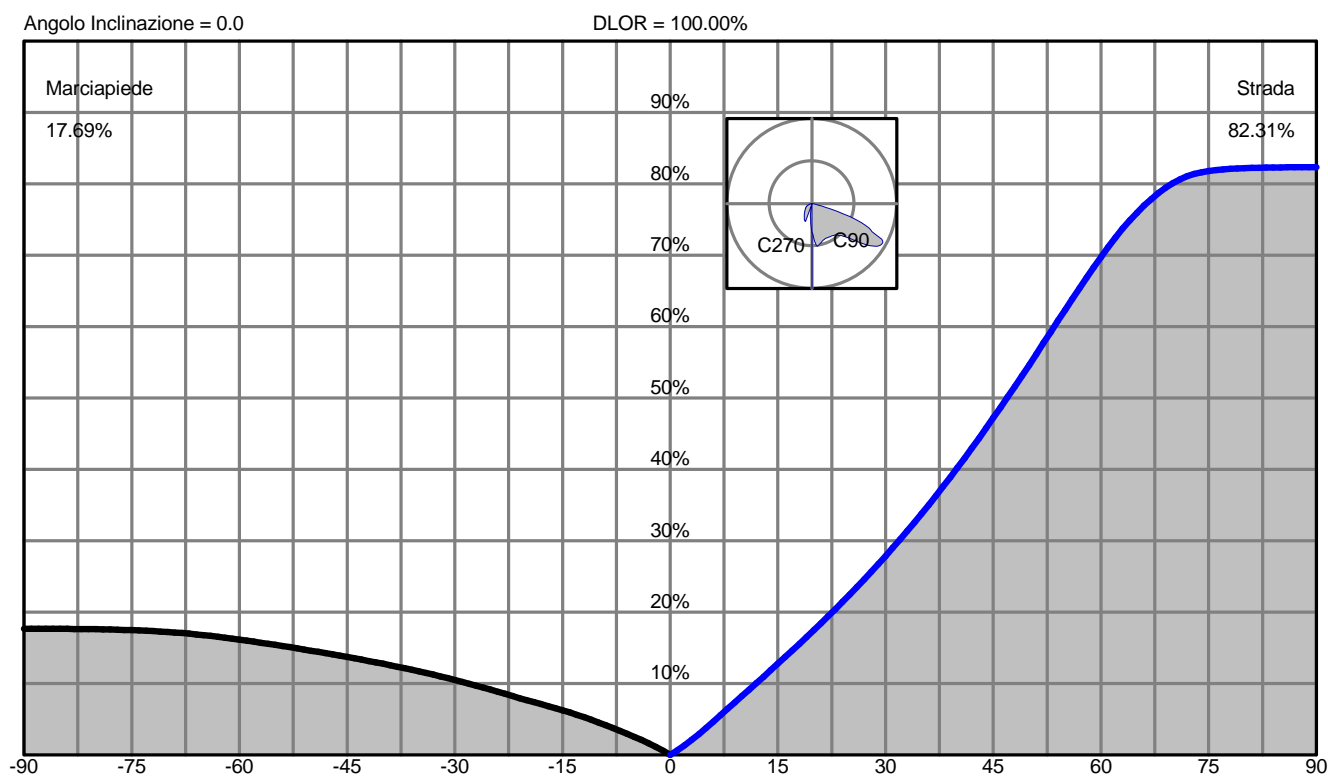

Spread	61.4° Largo	DLOR	100.00000 %
Throw	57.9° Corto	ULOR	0.00000 %
SLI	6.3 Ristretto	Rendimento	100.00000 %
Cutoff CIE	Cutoff - Max: C=45.0° Gamma=59.0°	RN	0.00000 %
Cutoff Iesna	Full Cutoff	Classe Intensità Luminosa	G4
DIN5044	KB2	Indice Abbagliamento	D5
IESNA Type III Short Asymmetrical			

Photometric Test Report



Costruttore	AEC ILLUMINAZIONE SRL
Tipo di prodotto	Outdoor Lighting Luminaire
Codice fotometria	ECO RAYS TP 0F2H1 STU-S 3.5-1M
Codice apparecchio	ECO RAYS TP 0F2H1 STU-S 3.5-1M
Rilievo fotometrico	18-009_0318
Descrizione apparecchio	ECO RAYS TP 0F2H1 STU-S 3.5-1M
Data emissione	03-04-2020

Foto del prodotto



Responsabile laboratorio fotometrico	Luca Vagheggi	
Tecnico laboratorio che ha eseguito la misura	Alessio Vagheggi	



Sommario e Allegati

Sommario	Dati apparecchio	
	Normative di riferimento	
	Procedure di riferimento	
	Condizioni di prova	
	Risultati fotometrici	
	Lista strumentazione	
	Incertezza strumentale	
Allegati	Dati Generali	X
	Tabella fotometrica delle Intensità (cd/Klm)	X
	Tabella fotometrica delle Intensità (cd)	
	Diagramma Polare	
	Diagramma Cartesiano	
	Valutazione UGR	
	Diagramma Sollner Abbagliamento	
	Flusso Zonale	
	Coefficienti di Utilizzazione	
	Isolux Unitario	
	Isocandele Percentuale	
	Tabella e Diagramma Luminanza	
	Classificazione Strade	X
Classificazione Strade IES TM-15		

DATI APPARECCHIO

Geometria apparecchio	Circolare		
Dimensioni apparecchio (mm)	Lunghezza / Diametro	Larghezza	Altezza
	497	497	665
Dimensioni area luminosa (mm)	Lunghezza / Diametro	Larghezza	Altezza C0
	60	110	0
	Altezza C90	Altezza C180	Altezza C270
	0	0	0
Tipo sorgente	LED		
Modello sorgente	Luxeon-Mx/Luxeon-Tx		
Tipo Alimentatore	Elettronico / Electronic		
Modello Alimentatore	Philips Xi		

NORMATIVE DI RIFERIMENTO

Normative di riferimento	UNI EN 13032-1:2012 UNI EN 13032-4:2015
Valutazione luce parassita	In accordo con Annex A UNI EN 13032-1

PROCEDURE DI RIFERIMENTO

Procedure di riferimento	I-QL-009
---------------------------------	----------

CONDIZIONI DI PROVA

Laboratorio fotometrico	Interno AEC ILLUMINAZIONE srl, in regime di sistema di qualità aziendale certificato ISO 9001:2008, autorizzato UL	
Condizioni Ambientali	Temperatura ambiente (°C)	25
	Umidità relativa (°RH)	< 60
	Movimento aria (m/s)	< 0.2
Condizioni Elettriche	Tensione di alimentazione (V)	230
	Frequenza di alimentazione (Hz)	50
	Distorsione armonica THD V (%)	< 0.5%
Condizioni Preliminari Prova	Metodo di misura	Goniofotometro
	Sistema di riferimento misura	Sistema C-γ (Gonio)
	Posizione di misura	Verticale (Gonio)
	Distanza di misura (m)	9.03
	Tempo di stabilizzazione (min)	> 60
	Instabilità sorgente (%)	< 0.5%

I risultati delle verifiche e prove qui riportati, si riferiscono esclusivamente agli esemplari esaminati e descritti nella presente Relazione. L'estensione del riferimento ad esemplari che non siano quelli sottoposti alle verifiche descritte in seguito esula dallo scopo delle verifiche stesse. E' vietata la riproduzione integrale o parziale senza l'autorizzazione scritta di Aec illuminazione srl. L'immagine dell'apparecchio nella prima pagina è puramente indicativa della tipologia di apparecchio sottoposto a test.

RISULTATI FOTOMETRICI

Tipo di misura fotometrica	Assoluta
LOR (%)	100.0
Flusso luminoso apparecchio (lm)	1660
Potenza ingresso apparecchio (W)	16.0
Efficienza apparecchio (lm/W)	104
Note e commenti	

LISTA STRUMENTAZIONE

CODICE AEC	STRUMENTO	COSTRUTTORE	MODELLO
Q129	Luxmetro	Czibula&Grundmann	100310
Q130	Goniofotometro	Oxytech	T2
Q131	Termoigrometro	Delta Ohm	HD2001
Q132	Wattmetro	N4L	PPA2510
Q135	Stabilizzatore	Elettrotest	TPS/M/9KW
Q205	Luxmetro	Czibula&Grundmann	161206

INCERTEZZA STRUMENTALE

Encoder goniofotometro Oxytech T2	Precisione angolare in C – gamma	$\pm 0.044^\circ$
Luxmetro C&G	f1'	< 1.23%
Wattmetro Kinetiq N4L PPA2510	Accuratezza di potenza	< [0.05% + 0.03%/pf + (0.01%/kHz)/pf] Rdg + 0.05%VA Rng

Apparecchio		Rilievo		Lampada	
Codice	ECO RAYS TP 0F2H1 STU-S 3.5-1M	Codice	18-009_0318	Codice	L-ECR-0F2H1-3000-525-1M-70-25
Nome	ECO RAYS TP 0F2H1 STU-S 3.5-1M	Nome	ECO RAYS TP 0F2H1 STU-S 3.5-1M	Numero	1
Archivio	Eulumdat	Data	03-04-2020	Posizione	

Flusso Apparecchio	1660.00 lm	Potenza Apparecchio	16.00 W	Efficacia	103.75 lm/W	Rendimento	100.00%
Flusso Lampade	1660.00 lm	Valore Massimo	765.04 cd/klm	Posizione	C=25.00 G=62.00	CG	Asimmetrico
Apparecchio Circolare		Diam.	497 mm	Alt.	665 mm	Alt.	0 mm
Area Luminosa Rettangolare		Lung.	60 mm	Larg.	110 mm		
Area Luminosa Orizzontale	0.006600 m2			Area Luminosa Piano 180°	0.000000 m2		
Area Luminosa Piano 0°	0.000000 m2			Area Luminosa Piano 270°	0.000000 m2		
Area Luminosa Piano 90°	0.000000 m2			Area Luminosa a 76°	0.001597 m2		
Sistema Coordinate		CG	03-04-2020	Tipo di Simmetria	Massimo Angolo Gamma	Asimmetrico	180
Data							

Lampade Apparecchio					
Archivio	Codice	Nome	Flusso [lm]	Pot. [W]	Q.tà
	L-ECR-0F2H1-3000-525-1M-70-25	L-ECR-0F2H1-3000-525-1M-70-25 - 16.00 W	1660.00	16.00	1
C.I.E.	40 73 96 100 100			D DIN 5040	A20
F UTE	1.00 G			B NBN	BZ 5

Diam=497mm

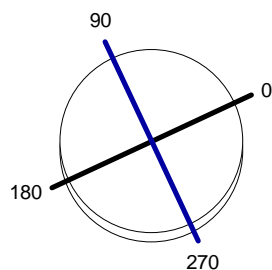

Semipiani C



ULOR	0.00 %
DLOR	100.00 %
RN	0.00 %

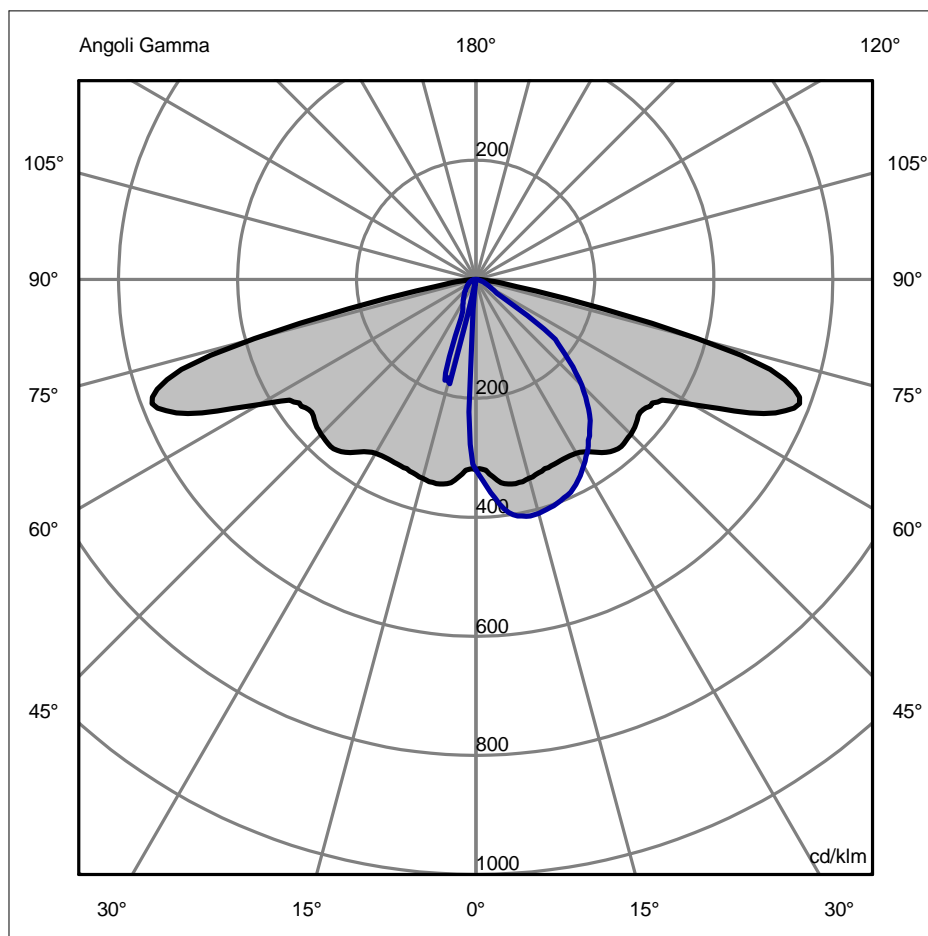

Apparecchio		Rilievo		Lampada	
Codice	ECO RAYS TP 0F2H1 STU-S 3.5-1M	Codice	18-009_0318	Codice	L-ECR-0F2H1-3000-525-1M-70-25
Nome	ECO RAYS TP 0F2H1 STU-S 3.5-1M	Nome	ECO RAYS TP 0F2H1 STU-S 3.5-1M	Numero	1
Archivio	Eulumdat	Data	03-04-2020	Posizione	

Flusso Apparecchio	1660.00 lm	Potenza Apparecchio	16.00 W	Efficacia	103.75 lm/W	Rendimento	100.00%
Flusso Lampade	1660.00 lm	Valore Massimo	765.04 cd/klm	Posizione	C=25.00 G=62.00	CG	Asimmetrico

	Tabella Intensità Luminose - cd/klm				Tabella 6/18			
	C 325.00	C 330.00	C 335.00	C 340.00	C 345.00	C 350.00	C 355.00	
G 0.0	319.99	319.99	319.99	319.99	319.99	319.99	319.99	
G 1.0	315.41	316.00	317.38	317.95	318.54	319.58	319.50	
G 2.0	311.68	312.49	314.53	315.47	316.71	318.78	319.62	
G 3.0	304.73	309.74	312.44	315.09	316.34	318.77	321.05	
G 4.0	277.70	301.82	311.20	317.22	319.81	324.71	326.98	
G 5.0	162.60	265.84	312.60	322.53	325.16	329.93	333.09	
G 6.0	151.27	231.05	315.74	323.79	328.02	333.32	336.86	
G 7.0	150.27	223.80	315.10	324.26	328.51	334.15	339.21	
G 8.0	148.90	212.46	313.81	323.31	328.07	334.71	340.67	
G 9.0	146.69	203.10	313.39	321.17	326.75	334.08	341.55	
G 10.0	143.70	195.20	310.94	319.46	324.80	332.11	340.53	
G 11.0	140.29	185.62	307.34	316.27	322.34	330.21	339.64	
G 12.0	131.90	164.83	304.99	312.93	319.95	327.80	338.19	
G 13.0	108.64	146.12	301.03	309.58	317.38	325.73	336.26	
G 14.0	91.53	140.37	297.46	306.27	314.18	323.26	334.21	
G 15.0	86.49	136.69	294.00	302.63	311.07	320.57	331.79	
G 16.0	81.43	122.56	273.57	298.96	307.76	317.61	329.98	
G 17.0	76.02	105.49	246.42	296.00	304.50	315.05	327.31	
G 18.0	68.11	87.32	190.49	292.87	301.42	311.90	324.97	
G 19.0	56.29	82.80	160.62	290.11	298.61	309.63	322.69	
G 20.0	44.42	78.55	133.31	287.61	295.66	307.70	320.92	
G 21.0	35.18	74.38	128.73	284.87	293.27	305.33	319.24	
G 22.0	27.70	70.32	123.45	282.45	290.91	303.52	317.78	
G 23.0	24.51	65.37	106.59	280.15	289.02	301.76	315.76	
G 24.0	61.37	59.59	97.11	276.84	287.56	299.70	314.86	
G 25.0	136.05	52.66	81.04	272.32	286.03	298.74	314.20	
G 26.0	155.37	46.01	76.25	250.52	284.71	297.51	313.94	
G 27.0	159.31	37.60	72.92	231.29	284.09	296.92	313.72	
G 28.0	170.06	35.70	69.81	201.86	283.59	296.45	313.74	
G 29.0	171.84	56.68	66.33	166.10	283.34	296.48	314.29	
G 30.0	158.89	109.74	63.35	146.82	283.47	296.87	315.97	
G 31.0	143.34	141.21	60.53	126.30	283.61	297.75	317.66	
G 32.0	124.55	143.93	57.91	113.21	283.48	298.69	319.32	
G 33.0	113.10	130.75	55.19	110.20	283.74	300.04	321.66	
G 34.0	97.05	118.25	52.46	107.47	283.73	301.40	324.53	
G 35.0	79.88	104.81	49.27	100.84	282.79	302.70	326.48	
G 36.0	64.83	102.77	46.65	89.23	281.59	303.15	328.03	
G 37.0	52.40	93.65	45.01	82.79	279.38	303.40	328.96	
G 38.0	42.05	80.26	42.38	73.71	276.36	302.86	329.37	
G 39.0	37.48	64.64	41.02	64.05	271.93	301.28	327.49	
G 40.0	37.82	49.20	43.05	60.80	266.62	298.17	324.88	
G 41.0	38.49	36.47	56.55	57.94	259.59	295.23	322.24	
G 42.0	39.18	28.07	61.90	55.06	250.91	290.84	319.50	
G 43.0	39.72	23.73	55.59	52.37	241.38	286.20	316.39	
G 44.0	40.28	23.26	53.12	50.33	232.90	281.62	313.01	
G 45.0	40.74	23.37	49.74	48.34	224.30	275.81	309.74	
G 46.0	41.09	23.53	39.04	46.53	214.39	270.57	305.86	
G 47.0	41.35	23.81	29.64	44.64	199.91	263.66	302.53	
G 48.0	41.64	24.14	24.95	42.97	183.35	256.89	298.27	
G 49.0	41.89	24.59	23.40	41.21	170.01	250.27	293.91	
G 50.0	42.10	25.03	22.49	39.72	151.22	243.76	290.45	
G 51.0	42.20	25.47	21.77	38.20	129.29	237.74	287.77	
G 52.0	42.21	25.92	21.18	37.05	111.87	232.08	286.17	
G 53.0	42.29	26.36	20.70	35.69	92.74	227.74	284.95	
G 54.0	42.36	26.75	20.32	34.77	70.84	224.19	284.82	
G 55.0	42.25	27.10	20.07	33.92	60.14	214.91	279.67	
G 56.0	42.19	27.45	19.86	33.35	55.41	201.31	272.61	
G 57.0	42.12	27.78	19.72	32.71	54.10	197.69	275.60	
G 58.0	41.82	28.07	19.56	31.65	52.73	196.21	281.74	
G 59.0	41.52	28.25	19.43	30.51	51.05	192.98	288.92	
G 60.0	41.23	28.42	19.32	29.43	49.04	188.90	297.55	
G 61.0	40.84	28.56	19.12	28.28	47.00	183.91	308.27	
G 62.0	40.39	28.61	18.97	27.36	45.02	178.23	319.52	
G 63.0	39.72	28.60	18.80	26.62	43.10	173.18	329.38	
G 64.0	38.83	28.50	18.58	25.94	41.20	169.00	338.84	
G 65.0	37.63	28.32	18.28	25.39	39.47	162.87	348.77	
G 66.0	36.51	28.08	17.99	24.97	38.11	154.29	356.08	
G 67.0	35.52	27.79	17.70	24.52	36.98	143.51	361.97	
G 68.0	34.99	27.48	17.35	23.96	36.02	132.01	364.70	
G 69.0	34.85	27.15	17.03	23.37	35.18	121.82	364.44	
G 70.0	35.04	26.74	16.64	22.67	34.48	112.80	350.24	
G 71.0	35.39	26.33	16.19	21.72	33.67	101.66	319.15	
G 72.0	35.87	25.72	15.72	20.71	32.74	88.05	307.69	

Apparecchio		Rilievo		Lampada	
Codice	ECO RAYS TP 0F2H1 STU-S 3.5-1M	Codice	18-009_0318	Codice	L-ECR-0F2H1-3000-525-1M-70-25
Nome	ECO RAYS TP 0F2H1 STU-S 3.5-1M	Nome	ECO RAYS TP 0F2H1 STU-S 3.5-1M	Numero	1
Archivio	Eulumdat	Data	03-04-2020	Posizione	

Flusso Apparecchio	1660.00 lm	Potenza Apparecchio	16.00 W	Efficacia	103.75 lm/W	Rendimento	100.00%
Flusso Lampade	1660.00 lm	Valore Massimo	765.04 cd/klm	Posizione	C=25.00 G=62.00	CG	Asimmetrico

	Tabella Intensità Luminose - cd/klm				Tabella 12/18			
	C 325.00	C 330.00	C 335.00	C 340.00	C 345.00	C 350.00	C 355.00	
G 73.0	36.36	25.05	15.01	19.40	31.38	71.81	281.43	
G 74.0	36.59	24.23	14.18	17.97	29.74	59.06	234.64	
G 75.0	36.19	23.26	13.24	16.09	27.66	51.08	182.35	
G 76.0	34.85	22.14	12.13	14.13	25.02	44.42	134.21	
G 77.0	32.65	20.60	11.19	12.12	22.33	37.76	101.25	
G 78.0	29.69	18.77	10.32	10.69	19.40	32.14	77.42	
G 79.0	26.18	16.65	9.41	9.47	16.69	26.82	60.69	
G 80.0	22.04	14.23	8.22	8.35	13.82	21.86	48.75	
G 81.0	17.56	11.80	7.19	7.14	11.27	17.81	39.14	
G 82.0	13.03	9.74	5.90	6.04	8.75	13.87	31.08	
G 83.0	9.61	7.37	4.60	4.56	6.38	10.33	23.59	
G 84.0	6.32	5.00	3.40	2.61	4.21	7.38	14.91	
G 85.0	3.63	2.95	1.68	1.29	2.70	4.92	9.71	
G 86.0	1.94	1.83	1.11	0.95	1.74	3.05	6.10	
G 87.0	0.99	0.96	0.79	0.74	1.14	1.65	2.73	
G 88.0	0.57	0.54	0.56	0.60	0.80	0.99	1.28	
G 89.0	0.37	0.42	0.48	0.53	0.60	0.63	0.65	
G 90.0	0.00	0.00	0.00	0.00	0.00	0.00	0.00	
G 91.0	0.00	0.00	0.00	0.00	0.00	0.00	0.00	
G 92.0	0.00	0.00	0.00	0.00	0.00	0.00	0.00	
G 93.0	0.00	0.00	0.00	0.00	0.00	0.00	0.00	
G 94.0	0.00	0.00	0.00	0.00	0.00	0.00	0.00	
G 95.0	0.00	0.00	0.00	0.00	0.00	0.00	0.00	
G 96.0	0.00	0.00	0.00	0.00	0.00	0.00	0.00	
G 97.0	0.00	0.00	0.00	0.00	0.00	0.00	0.00	
G 98.0	0.00	0.00	0.00	0.00	0.00	0.00	0.00	
G 99.0	0.00	0.00	0.00	0.00	0.00	0.00	0.00	
G100.0	0.00	0.00	0.00	0.00	0.00	0.00	0.00	
G101.0	0.00	0.00	0.00	0.00	0.00	0.00	0.00	
G102.0	0.00	0.00	0.00	0.00	0.00	0.00	0.00	
G103.0	0.00	0.00	0.00	0.00	0.00	0.00	0.00	
G104.0	0.00	0.00	0.00	0.00	0.00	0.00	0.00	
G105.0	0.00	0.00	0.00	0.00	0.00	0.00	0.00	
G106.0	0.00	0.00	0.00	0.00	0.00	0.00	0.00	
G107.0	0.00	0.00	0.00	0.00	0.00	0.00	0.00	
G108.0	0.00	0.00	0.00	0.00	0.00	0.00	0.00	
G109.0	0.00	0.00	0.00	0.00	0.00	0.00	0.00	
G110.0	0.00	0.00	0.00	0.00	0.00	0.00	0.00	
G111.0	0.00	0.00	0.00	0.00	0.00	0.00	0.00	
G112.0	0.00	0.00	0.00	0.00	0.00	0.00	0.00	
G113.0	0.00	0.00	0.00	0.00	0.00	0.00	0.00	
G114.0	0.00	0.00	0.00	0.00	0.00	0.00	0.00	
G115.0	0.00	0.00	0.00	0.00	0.00	0.00	0.00	
G116.0	0.00	0.00	0.00	0.00	0.00	0.00	0.00	
G117.0	0.00	0.00	0.00	0.00	0.00	0.00	0.00	
G118.0	0.00	0.00	0.00	0.00	0.00	0.00	0.00	
G119.0	0.00	0.00	0.00	0.00	0.00	0.00	0.00	
G120.0	0.00	0.00	0.00	0.00	0.00	0.00	0.00	
G121.0	0.00	0.00	0.00	0.00	0.00	0.00	0.00	
G122.0	0.00	0.00	0.00	0.00	0.00	0.00	0.00	
G123.0	0.00	0.00	0.00	0.00	0.00	0.00	0.00	
G124.0	0.00	0.00	0.00	0.00	0.00	0.00	0.00	
G125.0	0.00	0.00	0.00	0.00	0.00	0.00	0.00	
G126.0	0.00	0.00	0.00	0.00	0.00	0.00	0.00	
G127.0	0.00	0.00	0.00	0.00	0.00	0.00	0.00	
G128.0	0.00	0.00	0.00	0.00	0.00	0.00	0.00	
G129.0	0.00	0.00	0.00	0.00	0.00	0.00	0.00	
G130.0	0.00	0.00	0.00	0.00	0.00	0.00	0.00	
G131.0	0.00	0.00	0.00	0.00	0.00	0.00	0.00	
G132.0	0.00	0.00	0.00	0.00	0.00	0.00	0.00	
G133.0	0.00	0.00	0.00	0.00	0.00	0.00	0.00	
G134.0	0.00	0.00	0.00	0.00	0.00	0.00	0.00	
G135.0	0.00	0.00	0.00	0.00	0.00	0.00	0.00	
G136.0	0.00	0.00	0.00	0.00	0.00	0.00	0.00	
G137.0	0.00	0.00	0.00	0.00	0.00	0.00	0.00	
G138.0	0.00	0.00	0.00	0.00	0.00	0.00	0.00	
G139.0	0.00	0.00	0.00	0.00	0.00	0.00	0.00	
G140.0	0.00	0.00	0.00	0.00	0.00	0.00	0.00	
G141.0	0.00	0.00	0.00	0.00	0.00	0.00	0.00	
G142.0	0.00	0.00	0.00	0.00	0.00	0.00	0.00	
G143.0	0.00	0.00	0.00	0.00	0.00	0.00	0.00	
G144.0	0.00	0.00	0.00	0.00	0.00	0.00	0.00	
G145.0	0.00	0.00	0.00	0.00	0.00	0.00	0.00	

Apparecchio		Rilievo		Lampada	
Codice	ECO RAYS TP 0F2H1 STU-S 3.5-1M	Codice	18-009_0318	Codice	L-ECR-0F2H1-3000-525-1M-70-25
Nome	ECO RAYS TP 0F2H1 STU-S 3.5-1M	Nome	ECO RAYS TP 0F2H1 STU-S 3.5-1M	Numero	1
Archivio	Eulumdat	Data	03-04-2020	Posizione	

Flusso Apparecchio	1660.00 lm	Potenza Apparecchio	16.00 W	Efficacia	103.75 lm/W	Rendimento	100.00%
Flusso Lampade	1660.00 lm	Valore Massimo	765.04 cd/klm	Posizione	C=25.00 G=62.00	CG	Asimmetrico

Tabella Intensità Luminosa - cd/klm Tabella 13/18

	C 0.00	C 5.00	C 10.00	C 15.00	C 20.00	C 25.00	C 30.00	C 35.00	C 40.00	C 45.00	C 50.00	C 55.00	C 60.00
G146.0	0.00	0.00	0.00	0.00	0.00	0.00	0.00	0.00	0.00	0.00	0.00	0.00	0.00
G147.0	0.00	0.00	0.00	0.00	0.00	0.00	0.00	0.00	0.00	0.00	0.00	0.00	0.00
G148.0	0.00	0.00	0.00	0.00	0.00	0.00	0.00	0.00	0.00	0.00	0.00	0.00	0.00
G149.0	0.00	0.00	0.00	0.00	0.00	0.00	0.00	0.00	0.00	0.00	0.00	0.00	0.00
G150.0	0.00	0.00	0.00	0.00	0.00	0.00	0.00	0.00	0.00	0.00	0.00	0.00	0.00
G151.0	0.00	0.00	0.00	0.00	0.00	0.00	0.00	0.00	0.00	0.00	0.00	0.00	0.00
G152.0	0.00	0.00	0.00	0.00	0.00	0.00	0.00	0.00	0.00	0.00	0.00	0.00	0.00
G153.0	0.00	0.00	0.00	0.00	0.00	0.00	0.00	0.00	0.00	0.00	0.00	0.00	0.00
G154.0	0.00	0.00	0.00	0.00	0.00	0.00	0.00	0.00	0.00	0.00	0.00	0.00	0.00
G155.0	0.00	0.00	0.00	0.00	0.00	0.00	0.00	0.00	0.00	0.00	0.00	0.00	0.00
G156.0	0.00	0.00	0.00	0.00	0.00	0.00	0.00	0.00	0.00	0.00	0.00	0.00	0.00
G157.0	0.00	0.00	0.00	0.00	0.00	0.00	0.00	0.00	0.00	0.00	0.00	0.00	0.00
G158.0	0.00	0.00	0.00	0.00	0.00	0.00	0.00	0.00	0.00	0.00	0.00	0.00	0.00
G159.0	0.00	0.00	0.00	0.00	0.00	0.00	0.00	0.00	0.00	0.00	0.00	0.00	0.00
G160.0	0.00	0.00	0.00	0.00	0.00	0.00	0.00	0.00	0.00	0.00	0.00	0.00	0.00
G161.0	0.00	0.00	0.00	0.00	0.00	0.00	0.00	0.00	0.00	0.00	0.00	0.00	0.00
G162.0	0.00	0.00	0.00	0.00	0.00	0.00	0.00	0.00	0.00	0.00	0.00	0.00	0.00
G163.0	0.00	0.00	0.00	0.00	0.00	0.00	0.00	0.00	0.00	0.00	0.00	0.00	0.00
G164.0	0.00	0.00	0.00	0.00	0.00	0.00	0.00	0.00	0.00	0.00	0.00	0.00	0.00
G165.0	0.00	0.00	0.00	0.00	0.00	0.00	0.00	0.00	0.00	0.00	0.00	0.00	0.00
G166.0	0.00	0.00	0.00	0.00	0.00	0.00	0.00	0.00	0.00	0.00	0.00	0.00	0.00
G167.0	0.00	0.00	0.00	0.00	0.00	0.00	0.00	0.00	0.00	0.00	0.00	0.00	0.00
G168.0	0.00	0.00	0.00	0.00	0.00	0.00	0.00	0.00	0.00	0.00	0.00	0.00	0.00
G169.0	0.00	0.00	0.00	0.00	0.00	0.00	0.00	0.00	0.00	0.00	0.00	0.00	0.00
G170.0	0.00	0.00	0.00	0.00	0.00	0.00	0.00	0.00	0.00	0.00	0.00	0.00	0.00
G171.0	0.00	0.00	0.00	0.00	0.00	0.00	0.00	0.00	0.00	0.00	0.00	0.00	0.00
G172.0	0.00	0.00	0.00	0.00	0.00	0.00	0.00	0.00	0.00	0.00	0.00	0.00	0.00
G173.0	0.00	0.00	0.00	0.00	0.00	0.00	0.00	0.00	0.00	0.00	0.00	0.00	0.00
G174.0	0.00	0.00	0.00	0.00	0.00	0.00	0.00	0.00	0.00	0.00	0.00	0.00	0.00
G175.0	0.00	0.00	0.00	0.00	0.00	0.00	0.00	0.00	0.00	0.00	0.00	0.00	0.00
G176.0	0.00	0.00	0.00	0.00	0.00	0.00	0.00	0.00	0.00	0.00	0.00	0.00	0.00
G177.0	0.00	0.00	0.00	0.00	0.00	0.00	0.00	0.00	0.00	0.00	0.00	0.00	0.00
G178.0	0.00	0.00	0.00	0.00	0.00	0.00	0.00	0.00	0.00	0.00	0.00	0.00	0.00
G179.0	0.00	0.00	0.00	0.00	0.00	0.00	0.00	0.00	0.00	0.00	0.00	0.00	0.00
G180.0	0.00	0.00	0.00	0.00	0.00	0.00	0.00	0.00	0.00	0.00	0.00	0.00	0.00

Apparecchio		Rilievo		Lampada	
Codice	ECO RAYS TP 0F2H1 STU-S 3.5-1M	Codice	18-009_0318	Codice	L-ECR-0F2H1-3000-525-1M-70-25
Nome	ECO RAYS TP 0F2H1 STU-S 3.5-1M	Nome	ECO RAYS TP 0F2H1 STU-S 3.5-1M	Numero	1
Archivio	Eulumdat	Data	03-04-2020	Posizione	

Flusso Apparecchio	1660.00 lm	Potenza Apparecchio	16.00 W	Efficacia	103.75 lm/W	Rendimento	100.00%
Flusso Lampade	1660.00 lm	Valore Massimo	765.04 cd/klm	Posizione	C=25.00 G=62.00	CG	Asimmetrico

Tabella Intensità Luminose - cd/klm Tabella 14/18

	C 65.00	C 70.00	C 75.00	C 80.00	C 85.00	C 90.00	C 95.00	C 100.00	C 105.00	C 110.00	C 115.00	C 120.00	C 125.00
G146.0	0.00	0.00	0.00	0.00	0.00	0.00	0.00	0.00	0.00	0.00	0.00	0.00	0.00
G147.0	0.00	0.00	0.00	0.00	0.00	0.00	0.00	0.00	0.00	0.00	0.00	0.00	0.00
G148.0	0.00	0.00	0.00	0.00	0.00	0.00	0.00	0.00	0.00	0.00	0.00	0.00	0.00
G149.0	0.00	0.00	0.00	0.00	0.00	0.00	0.00	0.00	0.00	0.00	0.00	0.00	0.00
G150.0	0.00	0.00	0.00	0.00	0.00	0.00	0.00	0.00	0.00	0.00	0.00	0.00	0.00
G151.0	0.00	0.00	0.00	0.00	0.00	0.00	0.00	0.00	0.00	0.00	0.00	0.00	0.00
G152.0	0.00	0.00	0.00	0.00	0.00	0.00	0.00	0.00	0.00	0.00	0.00	0.00	0.00
G153.0	0.00	0.00	0.00	0.00	0.00	0.00	0.00	0.00	0.00	0.00	0.00	0.00	0.00
G154.0	0.00	0.00	0.00	0.00	0.00	0.00	0.00	0.00	0.00	0.00	0.00	0.00	0.00
G155.0	0.00	0.00	0.00	0.00	0.00	0.00	0.00	0.00	0.00	0.00	0.00	0.00	0.00
G156.0	0.00	0.00	0.00	0.00	0.00	0.00	0.00	0.00	0.00	0.00	0.00	0.00	0.00
G157.0	0.00	0.00	0.00	0.00	0.00	0.00	0.00	0.00	0.00	0.00	0.00	0.00	0.00
G158.0	0.00	0.00	0.00	0.00	0.00	0.00	0.00	0.00	0.00	0.00	0.00	0.00	0.00
G159.0	0.00	0.00	0.00	0.00	0.00	0.00	0.00	0.00	0.00	0.00	0.00	0.00	0.00
G160.0	0.00	0.00	0.00	0.00	0.00	0.00	0.00	0.00	0.00	0.00	0.00	0.00	0.00
G161.0	0.00	0.00	0.00	0.00	0.00	0.00	0.00	0.00	0.00	0.00	0.00	0.00	0.00
G162.0	0.00	0.00	0.00	0.00	0.00	0.00	0.00	0.00	0.00	0.00	0.00	0.00	0.00
G163.0	0.00	0.00	0.00	0.00	0.00	0.00	0.00	0.00	0.00	0.00	0.00	0.00	0.00
G164.0	0.00	0.00	0.00	0.00	0.00	0.00	0.00	0.00	0.00	0.00	0.00	0.00	0.00
G165.0	0.00	0.00	0.00	0.00	0.00	0.00	0.00	0.00	0.00	0.00	0.00	0.00	0.00
G166.0	0.00	0.00	0.00	0.00	0.00	0.00	0.00	0.00	0.00	0.00	0.00	0.00	0.00
G167.0	0.00	0.00	0.00	0.00	0.00	0.00	0.00	0.00	0.00	0.00	0.00	0.00	0.00
G168.0	0.00	0.00	0.00	0.00	0.00	0.00	0.00	0.00	0.00	0.00	0.00	0.00	0.00
G169.0	0.00	0.00	0.00	0.00	0.00	0.00	0.00	0.00	0.00	0.00	0.00	0.00	0.00
G170.0	0.00	0.00	0.00	0.00	0.00	0.00	0.00	0.00	0.00	0.00	0.00	0.00	0.00
G171.0	0.00	0.00	0.00	0.00	0.00	0.00	0.00	0.00	0.00	0.00	0.00	0.00	0.00
G172.0	0.00	0.00	0.00	0.00	0.00	0.00	0.00	0.00	0.00	0.00	0.00	0.00	0.00
G173.0	0.00	0.00	0.00	0.00	0.00	0.00	0.00	0.00	0.00	0.00	0.00	0.00	0.00
G174.0	0.00	0.00	0.00	0.00	0.00	0.00	0.00	0.00	0.00	0.00	0.00	0.00	0.00
G175.0	0.00	0.00	0.00	0.00	0.00	0.00	0.00	0.00	0.00	0.00	0.00	0.00	0.00
G176.0	0.00	0.00	0.00	0.00	0.00	0.00	0.00	0.00	0.00	0.00	0.00	0.00	0.00
G177.0	0.00	0.00	0.00	0.00	0.00	0.00	0.00	0.00	0.00	0.00	0.00	0.00	0.00
G178.0	0.00	0.00	0.00	0.00	0.00	0.00	0.00	0.00	0.00	0.00	0.00	0.00	0.00
G179.0	0.00	0.00	0.00	0.00	0.00	0.00	0.00	0.00	0.00	0.00	0.00	0.00	0.00
G180.0	0.00	0.00	0.00	0.00	0.00	0.00	0.00	0.00	0.00	0.00	0.00	0.00	0.00

Apparecchio		Rilievo		Lampada	
Codice	ECO RAYS TP 0F2H1 STU-S 3.5-1M	Codice	18-009_0318	Codice	L-ECR-0F2H1-3000-525-1M-70-25
Nome	ECO RAYS TP 0F2H1 STU-S 3.5-1M	Nome	ECO RAYS TP 0F2H1 STU-S 3.5-1M	Numero	1
Archivio	Eulumdat	Data	03-04-2020	Posizione	

Flusso Apparecchio	1660.00 lm	Potenza Apparecchio	16.00 W	Efficacia	103.75 lm/W	Rendimento	100.00%
Flusso Lampade	1660.00 lm	Valore Massimo	765.04 cd/klm	Posizione	C=25.00 G=62.00	CG	Asimmetrico

Tabella Intensità Luminose - cd/klm Tabella 15/18

	C 130.00	C 135.00	C 140.00	C 145.00	C 150.00	C 155.00	C 160.00	C 165.00	C 170.00	C 175.00	C 180.00	C 185.00	C 190.00
G146.0	0.00	0.00	0.00	0.00	0.00	0.00	0.00	0.00	0.00	0.00	0.00	0.00	0.00
G147.0	0.00	0.00	0.00	0.00	0.00	0.00	0.00	0.00	0.00	0.00	0.00	0.00	0.00
G148.0	0.00	0.00	0.00	0.00	0.00	0.00	0.00	0.00	0.00	0.00	0.00	0.00	0.00
G149.0	0.00	0.00	0.00	0.00	0.00	0.00	0.00	0.00	0.00	0.00	0.00	0.00	0.00
G150.0	0.00	0.00	0.00	0.00	0.00	0.00	0.00	0.00	0.00	0.00	0.00	0.00	0.00
G151.0	0.00	0.00	0.00	0.00	0.00	0.00	0.00	0.00	0.00	0.00	0.00	0.00	0.00
G152.0	0.00	0.00	0.00	0.00	0.00	0.00	0.00	0.00	0.00	0.00	0.00	0.00	0.00
G153.0	0.00	0.00	0.00	0.00	0.00	0.00	0.00	0.00	0.00	0.00	0.00	0.00	0.00
G154.0	0.00	0.00	0.00	0.00	0.00	0.00	0.00	0.00	0.00	0.00	0.00	0.00	0.00
G155.0	0.00	0.00	0.00	0.00	0.00	0.00	0.00	0.00	0.00	0.00	0.00	0.00	0.00
G156.0	0.00	0.00	0.00	0.00	0.00	0.00	0.00	0.00	0.00	0.00	0.00	0.00	0.00
G157.0	0.00	0.00	0.00	0.00	0.00	0.00	0.00	0.00	0.00	0.00	0.00	0.00	0.00
G158.0	0.00	0.00	0.00	0.00	0.00	0.00	0.00	0.00	0.00	0.00	0.00	0.00	0.00
G159.0	0.00	0.00	0.00	0.00	0.00	0.00	0.00	0.00	0.00	0.00	0.00	0.00	0.00
G160.0	0.00	0.00	0.00	0.00	0.00	0.00	0.00	0.00	0.00	0.00	0.00	0.00	0.00
G161.0	0.00	0.00	0.00	0.00	0.00	0.00	0.00	0.00	0.00	0.00	0.00	0.00	0.00
G162.0	0.00	0.00	0.00	0.00	0.00	0.00	0.00	0.00	0.00	0.00	0.00	0.00	0.00
G163.0	0.00	0.00	0.00	0.00	0.00	0.00	0.00	0.00	0.00	0.00	0.00	0.00	0.00
G164.0	0.00	0.00	0.00	0.00	0.00	0.00	0.00	0.00	0.00	0.00	0.00	0.00	0.00
G165.0	0.00	0.00	0.00	0.00	0.00	0.00	0.00	0.00	0.00	0.00	0.00	0.00	0.00
G166.0	0.00	0.00	0.00	0.00	0.00	0.00	0.00	0.00	0.00	0.00	0.00	0.00	0.00
G167.0	0.00	0.00	0.00	0.00	0.00	0.00	0.00	0.00	0.00	0.00	0.00	0.00	0.00
G168.0	0.00	0.00	0.00	0.00	0.00	0.00	0.00	0.00	0.00	0.00	0.00	0.00	0.00
G169.0	0.00	0.00	0.00	0.00	0.00	0.00	0.00	0.00	0.00	0.00	0.00	0.00	0.00
G170.0	0.00	0.00	0.00	0.00	0.00	0.00	0.00	0.00	0.00	0.00	0.00	0.00	0.00
G171.0	0.00	0.00	0.00	0.00	0.00	0.00	0.00	0.00	0.00	0.00	0.00	0.00	0.00
G172.0	0.00	0.00	0.00	0.00	0.00	0.00	0.00	0.00	0.00	0.00	0.00	0.00	0.00
G173.0	0.00	0.00	0.00	0.00	0.00	0.00	0.00	0.00	0.00	0.00	0.00	0.00	0.00
G174.0	0.00	0.00	0.00	0.00	0.00	0.00	0.00	0.00	0.00	0.00	0.00	0.00	0.00
G175.0	0.00	0.00	0.00	0.00	0.00	0.00	0.00	0.00	0.00	0.00	0.00	0.00	0.00
G176.0	0.00	0.00	0.00	0.00	0.00	0.00	0.00	0.00	0.00	0.00	0.00	0.00	0.00
G177.0	0.00	0.00	0.00	0.00	0.00	0.00	0.00	0.00	0.00	0.00	0.00	0.00	0.00
G178.0	0.00	0.00	0.00	0.00	0.00	0.00	0.00	0.00	0.00	0.00	0.00	0.00	0.00
G179.0	0.00	0.00	0.00	0.00	0.00	0.00	0.00	0.00	0.00	0.00	0.00	0.00	0.00
G180.0	0.00	0.00	0.00	0.00	0.00	0.00	0.00	0.00	0.00	0.00	0.00	0.00	0.00

Apparecchio		Rilievo		Lampada	
Codice	ECO RAYS TP 0F2H1 STU-S 3.5-1M	Codice	18-009_0318	Codice	L-ECR-0F2H1-3000-525-1M-70-25
Nome	ECO RAYS TP 0F2H1 STU-S 3.5-1M	Nome	ECO RAYS TP 0F2H1 STU-S 3.5-1M	Numero	1
Archivio	Eulumdat	Data	03-04-2020	Posizione	

Flusso Apparecchio	1660.00 lm	Potenza Apparecchio	16.00 W	Efficacia	103.75 lm/W	Rendimento	100.00%
Flusso Lampade	1660.00 lm	Valore Massimo	765.04 cd/klm	Posizione	C=25.00 G=62.00	CG	Asimmetrico

Tabella Intensità Luminose - cd/klm Tabella 16/18

	C 195.00	C 200.00	C 205.00	C 210.00	C 215.00	C 220.00	C 225.00	C 230.00	C 235.00	C 240.00	C 245.00	C 250.00	C 255.00
G146.0	0.00	0.00	0.00	0.00	0.00	0.00	0.00	0.00	0.00	0.00	0.00	0.00	0.00
G147.0	0.00	0.00	0.00	0.00	0.00	0.00	0.00	0.00	0.00	0.00	0.00	0.00	0.00
G148.0	0.00	0.00	0.00	0.00	0.00	0.00	0.00	0.00	0.00	0.00	0.00	0.00	0.00
G149.0	0.00	0.00	0.00	0.00	0.00	0.00	0.00	0.00	0.00	0.00	0.00	0.00	0.00
G150.0	0.00	0.00	0.00	0.00	0.00	0.00	0.00	0.00	0.00	0.00	0.00	0.00	0.00
G151.0	0.00	0.00	0.00	0.00	0.00	0.00	0.00	0.00	0.00	0.00	0.00	0.00	0.00
G152.0	0.00	0.00	0.00	0.00	0.00	0.00	0.00	0.00	0.00	0.00	0.00	0.00	0.00
G153.0	0.00	0.00	0.00	0.00	0.00	0.00	0.00	0.00	0.00	0.00	0.00	0.00	0.00
G154.0	0.00	0.00	0.00	0.00	0.00	0.00	0.00	0.00	0.00	0.00	0.00	0.00	0.00
G155.0	0.00	0.00	0.00	0.00	0.00	0.00	0.00	0.00	0.00	0.00	0.00	0.00	0.00
G156.0	0.00	0.00	0.00	0.00	0.00	0.00	0.00	0.00	0.00	0.00	0.00	0.00	0.00
G157.0	0.00	0.00	0.00	0.00	0.00	0.00	0.00	0.00	0.00	0.00	0.00	0.00	0.00
G158.0	0.00	0.00	0.00	0.00	0.00	0.00	0.00	0.00	0.00	0.00	0.00	0.00	0.00
G159.0	0.00	0.00	0.00	0.00	0.00	0.00	0.00	0.00	0.00	0.00	0.00	0.00	0.00
G160.0	0.00	0.00	0.00	0.00	0.00	0.00	0.00	0.00	0.00	0.00	0.00	0.00	0.00
G161.0	0.00	0.00	0.00	0.00	0.00	0.00	0.00	0.00	0.00	0.00	0.00	0.00	0.00
G162.0	0.00	0.00	0.00	0.00	0.00	0.00	0.00	0.00	0.00	0.00	0.00	0.00	0.00
G163.0	0.00	0.00	0.00	0.00	0.00	0.00	0.00	0.00	0.00	0.00	0.00	0.00	0.00
G164.0	0.00	0.00	0.00	0.00	0.00	0.00	0.00	0.00	0.00	0.00	0.00	0.00	0.00
G165.0	0.00	0.00	0.00	0.00	0.00	0.00	0.00	0.00	0.00	0.00	0.00	0.00	0.00
G166.0	0.00	0.00	0.00	0.00	0.00	0.00	0.00	0.00	0.00	0.00	0.00	0.00	0.00
G167.0	0.00	0.00	0.00	0.00	0.00	0.00	0.00	0.00	0.00	0.00	0.00	0.00	0.00
G168.0	0.00	0.00	0.00	0.00	0.00	0.00	0.00	0.00	0.00	0.00	0.00	0.00	0.00
G169.0	0.00	0.00	0.00	0.00	0.00	0.00	0.00	0.00	0.00	0.00	0.00	0.00	0.00
G170.0	0.00	0.00	0.00	0.00	0.00	0.00	0.00	0.00	0.00	0.00	0.00	0.00	0.00
G171.0	0.00	0.00	0.00	0.00	0.00	0.00	0.00	0.00	0.00	0.00	0.00	0.00	0.00
G172.0	0.00	0.00	0.00	0.00	0.00	0.00	0.00	0.00	0.00	0.00	0.00	0.00	0.00
G173.0	0.00	0.00	0.00	0.00	0.00	0.00	0.00	0.00	0.00	0.00	0.00	0.00	0.00
G174.0	0.00	0.00	0.00	0.00	0.00	0.00	0.00	0.00	0.00	0.00	0.00	0.00	0.00
G175.0	0.00	0.00	0.00	0.00	0.00	0.00	0.00	0.00	0.00	0.00	0.00	0.00	0.00
G176.0	0.00	0.00	0.00	0.00	0.00	0.00	0.00	0.00	0.00	0.00	0.00	0.00	0.00
G177.0	0.00	0.00	0.00	0.00	0.00	0.00	0.00	0.00	0.00	0.00	0.00	0.00	0.00
G178.0	0.00	0.00	0.00	0.00	0.00	0.00	0.00	0.00	0.00	0.00	0.00	0.00	0.00
G179.0	0.00	0.00	0.00	0.00	0.00	0.00	0.00	0.00	0.00	0.00	0.00	0.00	0.00
G180.0	0.00	0.00	0.00	0.00	0.00	0.00	0.00	0.00	0.00	0.00	0.00	0.00	0.00

Apparecchio		Rilievo		Lampada	
Codice	ECO RAYS TP 0F2H1 STU-S 3.5-1M	Codice	18-009_0318	Codice	L-ECR-0F2H1-3000-525-1M-70-25
Nome	ECO RAYS TP 0F2H1 STU-S 3.5-1M	Nome	ECO RAYS TP 0F2H1 STU-S 3.5-1M	Numero	1
Archivio	Eulumdat	Data	03-04-2020	Posizione	

Flusso Apparecchio	1660.00 lm	Potenza Apparecchio	16.00 W	Efficacia	103.75 lm/W	Rendimento	100.00%
Flusso Lampade	1660.00 lm	Valore Massimo	765.04 cd/klm	Posizione	C=25.00 G=62.00	CG	Asimmetrico

Tabella Intensità Luminose - cd/klm Tabella 17/18

	C 260.00	C 265.00	C 270.00	C 275.00	C 280.00	C 285.00	C 290.00	C 295.00	C 300.00	C 305.00	C 310.00	C 315.00	C 320.00
G146.0	0.00	0.00	0.00	0.00	0.00	0.00	0.00	0.00	0.00	0.00	0.00	0.00	0.00
G147.0	0.00	0.00	0.00	0.00	0.00	0.00	0.00	0.00	0.00	0.00	0.00	0.00	0.00
G148.0	0.00	0.00	0.00	0.00	0.00	0.00	0.00	0.00	0.00	0.00	0.00	0.00	0.00
G149.0	0.00	0.00	0.00	0.00	0.00	0.00	0.00	0.00	0.00	0.00	0.00	0.00	0.00
G150.0	0.00	0.00	0.00	0.00	0.00	0.00	0.00	0.00	0.00	0.00	0.00	0.00	0.00
G151.0	0.00	0.00	0.00	0.00	0.00	0.00	0.00	0.00	0.00	0.00	0.00	0.00	0.00
G152.0	0.00	0.00	0.00	0.00	0.00	0.00	0.00	0.00	0.00	0.00	0.00	0.00	0.00
G153.0	0.00	0.00	0.00	0.00	0.00	0.00	0.00	0.00	0.00	0.00	0.00	0.00	0.00
G154.0	0.00	0.00	0.00	0.00	0.00	0.00	0.00	0.00	0.00	0.00	0.00	0.00	0.00
G155.0	0.00	0.00	0.00	0.00	0.00	0.00	0.00	0.00	0.00	0.00	0.00	0.00	0.00
G156.0	0.00	0.00	0.00	0.00	0.00	0.00	0.00	0.00	0.00	0.00	0.00	0.00	0.00
G157.0	0.00	0.00	0.00	0.00	0.00	0.00	0.00	0.00	0.00	0.00	0.00	0.00	0.00
G158.0	0.00	0.00	0.00	0.00	0.00	0.00	0.00	0.00	0.00	0.00	0.00	0.00	0.00
G159.0	0.00	0.00	0.00	0.00	0.00	0.00	0.00	0.00	0.00	0.00	0.00	0.00	0.00
G160.0	0.00	0.00	0.00	0.00	0.00	0.00	0.00	0.00	0.00	0.00	0.00	0.00	0.00
G161.0	0.00	0.00	0.00	0.00	0.00	0.00	0.00	0.00	0.00	0.00	0.00	0.00	0.00
G162.0	0.00	0.00	0.00	0.00	0.00	0.00	0.00	0.00	0.00	0.00	0.00	0.00	0.00
G163.0	0.00	0.00	0.00	0.00	0.00	0.00	0.00	0.00	0.00	0.00	0.00	0.00	0.00
G164.0	0.00	0.00	0.00	0.00	0.00	0.00	0.00	0.00	0.00	0.00	0.00	0.00	0.00
G165.0	0.00	0.00	0.00	0.00	0.00	0.00	0.00	0.00	0.00	0.00	0.00	0.00	0.00
G166.0	0.00	0.00	0.00	0.00	0.00	0.00	0.00	0.00	0.00	0.00	0.00	0.00	0.00
G167.0	0.00	0.00	0.00	0.00	0.00	0.00	0.00	0.00	0.00	0.00	0.00	0.00	0.00
G168.0	0.00	0.00	0.00	0.00	0.00	0.00	0.00	0.00	0.00	0.00	0.00	0.00	0.00
G169.0	0.00	0.00	0.00	0.00	0.00	0.00	0.00	0.00	0.00	0.00	0.00	0.00	0.00
G170.0	0.00	0.00	0.00	0.00	0.00	0.00	0.00	0.00	0.00	0.00	0.00	0.00	0.00
G171.0	0.00	0.00	0.00	0.00	0.00	0.00	0.00	0.00	0.00	0.00	0.00	0.00	0.00
G172.0	0.00	0.00	0.00	0.00	0.00	0.00	0.00	0.00	0.00	0.00	0.00	0.00	0.00
G173.0	0.00	0.00	0.00	0.00	0.00	0.00	0.00	0.00	0.00	0.00	0.00	0.00	0.00
G174.0	0.00	0.00	0.00	0.00	0.00	0.00	0.00	0.00	0.00	0.00	0.00	0.00	0.00
G175.0	0.00	0.00	0.00	0.00	0.00	0.00	0.00	0.00	0.00	0.00	0.00	0.00	0.00
G176.0	0.00	0.00	0.00	0.00	0.00	0.00	0.00	0.00	0.00	0.00	0.00	0.00	0.00
G177.0	0.00	0.00	0.00	0.00	0.00	0.00	0.00	0.00	0.00	0.00	0.00	0.00	0.00
G178.0	0.00	0.00	0.00	0.00	0.00	0.00	0.00	0.00	0.00	0.00	0.00	0.00	0.00
G179.0	0.00	0.00	0.00	0.00	0.00	0.00	0.00	0.00	0.00	0.00	0.00	0.00	0.00
G180.0	0.00	0.00	0.00	0.00	0.00	0.00	0.00	0.00	0.00	0.00	0.00	0.00	0.00

Apparecchio		Rilievo		Lampada	
Codice	ECO RAYS TP 0F2H1 STU-S 3.5-1M	Codice	18-009_0318	Codice	L-ECR-0F2H1-3000-525-1M-70-25
Nome	ECO RAYS TP 0F2H1 STU-S 3.5-1M	Nome	ECO RAYS TP 0F2H1 STU-S 3.5-1M	Numero	1
Archivio	Eulumdat	Data	03-04-2020	Posizione	

Flusso Apparecchio	1660.00 lm	Potenza Apparecchio	16.00 W	Efficacia	103.75 lm/W	Rendimento	100.00%
Flusso Lampade	1660.00 lm	Valore Massimo	765.04 cd/klm	Posizione	C=25.00 G=62.00	CG	Asimmetrico

Tabella Intensità Luminosa - cd/klm Tabella 18/18

	C 325.00	C 330.00	C 335.00	C 340.00	C 345.00	C 350.00	C 355.00
G146.0	0.00	0.00	0.00	0.00	0.00	0.00	0.00
G147.0	0.00	0.00	0.00	0.00	0.00	0.00	0.00
G148.0	0.00	0.00	0.00	0.00	0.00	0.00	0.00
G149.0	0.00	0.00	0.00	0.00	0.00	0.00	0.00
G150.0	0.00	0.00	0.00	0.00	0.00	0.00	0.00
G151.0	0.00	0.00	0.00	0.00	0.00	0.00	0.00
G152.0	0.00	0.00	0.00	0.00	0.00	0.00	0.00
G153.0	0.00	0.00	0.00	0.00	0.00	0.00	0.00
G154.0	0.00	0.00	0.00	0.00	0.00	0.00	0.00
G155.0	0.00	0.00	0.00	0.00	0.00	0.00	0.00
G156.0	0.00	0.00	0.00	0.00	0.00	0.00	0.00
G157.0	0.00	0.00	0.00	0.00	0.00	0.00	0.00
G158.0	0.00	0.00	0.00	0.00	0.00	0.00	0.00
G159.0	0.00	0.00	0.00	0.00	0.00	0.00	0.00
G160.0	0.00	0.00	0.00	0.00	0.00	0.00	0.00
G161.0	0.00	0.00	0.00	0.00	0.00	0.00	0.00
G162.0	0.00	0.00	0.00	0.00	0.00	0.00	0.00
G163.0	0.00	0.00	0.00	0.00	0.00	0.00	0.00
G164.0	0.00	0.00	0.00	0.00	0.00	0.00	0.00
G165.0	0.00	0.00	0.00	0.00	0.00	0.00	0.00
G166.0	0.00	0.00	0.00	0.00	0.00	0.00	0.00
G167.0	0.00	0.00	0.00	0.00	0.00	0.00	0.00
G168.0	0.00	0.00	0.00	0.00	0.00	0.00	0.00
G169.0	0.00	0.00	0.00	0.00	0.00	0.00	0.00
G170.0	0.00	0.00	0.00	0.00	0.00	0.00	0.00
G171.0	0.00	0.00	0.00	0.00	0.00	0.00	0.00
G172.0	0.00	0.00	0.00	0.00	0.00	0.00	0.00
G173.0	0.00	0.00	0.00	0.00	0.00	0.00	0.00
G174.0	0.00	0.00	0.00	0.00	0.00	0.00	0.00
G175.0	0.00	0.00	0.00	0.00	0.00	0.00	0.00
G176.0	0.00	0.00	0.00	0.00	0.00	0.00	0.00
G177.0	0.00	0.00	0.00	0.00	0.00	0.00	0.00
G178.0	0.00	0.00	0.00	0.00	0.00	0.00	0.00
G179.0	0.00	0.00	0.00	0.00	0.00	0.00	0.00
G180.0	0.00	0.00	0.00	0.00	0.00	0.00	0.00

Apparecchio		Rilievo		Lampada	
Codice	ECO RAYS TP 0F2H1 STU-S 3.5-1M	Codice	18-009_0318	Codice	L-ECR-0F2H1-3000-525-1M-70-25
Nome	ECO RAYS TP 0F2H1 STU-S 3.5-1M	Nome	ECO RAYS TP 0F2H1 STU-S 3.5-1M	Numero	1
Archivio	Eulumdat	Data	03-04-2020	Posizione	

Flusso Apparecchio	1660.00 lm	Potenza Apparecchio	16.00 W	Efficacia	103.75 lm/W	Rendimento	100.00%
Flusso Lampade	1660.00 lm	Valore Massimo	765.04 cd/klm	Posizione	C=25.00 G=62.00	CG	Asimmetrico

Marciapiede			Strada		
Piano	0	0.00%	Piano	0	0.00%
Piano	-5	5.66%	Piano	5	6.64%
Piano	-10	9.74%	Piano	10	13.82%
Piano	-15	12.43%	Piano	15	21.18%
Piano	-20	14.99%	Piano	20	28.50%
Piano	-25	16.37%	Piano	25	35.85%
Piano	-30	17.18%	Piano	30	43.39%
Piano	-35	17.88%	Piano	35	51.19%
Piano	-40	18.50%	Piano	40	59.06%
Piano	-45	19.08%	Piano	45	66.43%
Piano	-50	19.59%	Piano	50	72.05%
Piano	-55	20.05%	Piano	55	75.56%
Piano	-60	20.45%	Piano	60	76.87%
Piano	-65	20.80%	Piano	65	77.58%
Piano	-70	21.09%	Piano	70	78.02%
Piano	-75	21.32%	Piano	75	78.29%
Piano	-80	21.44%	Piano	80	78.44%
Piano	-85	21.48%	Piano	85	78.50%
Piano	-90	21.49%	Piano	90	78.51%

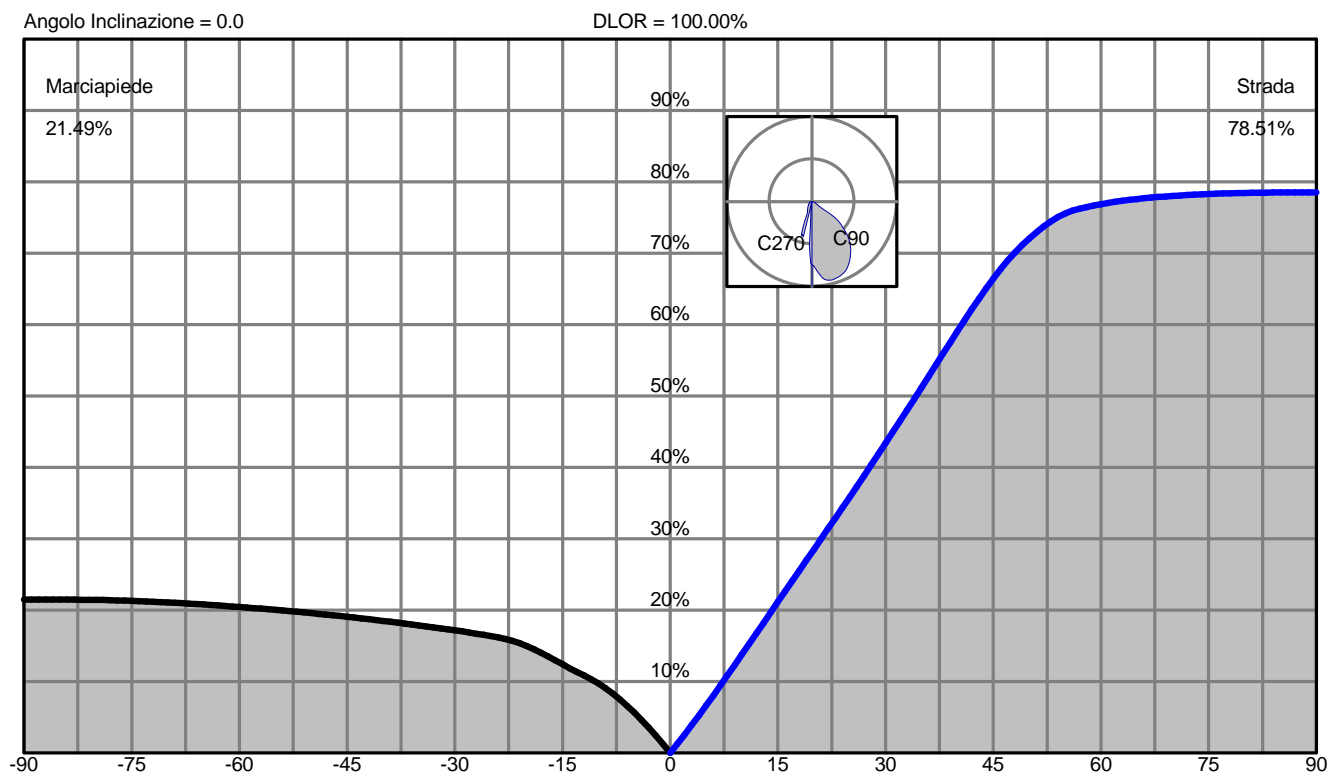

Spread	45.8° Medio	DLOR	100.00000 %
Throw	62.0° Intermedio	ULOR	0.00000 %
SLI	4.9 Ristretto	Rendimento	100.00000 %
Cutoff CIE	Semi Cutoff - Max: C=25.0° Gamma=62.0°	RN	0.00000 %
Cutoff Iesna	Semi Cutoff	Classe Intensità Luminosa	G2
DIN5044	--	Indice Abbagliamento	D4
IESNA Type II Short Asymmetrical			

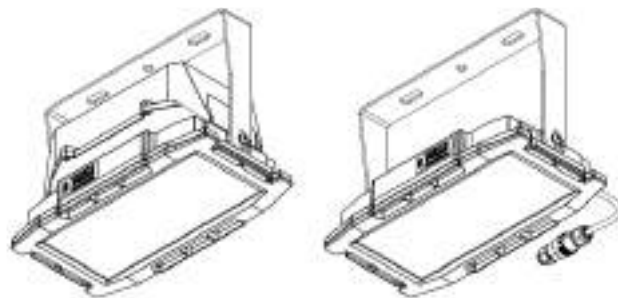

GALILEO 1

CARATTERISTICHE PRINCIPALI

Applicazioni	Illuminazione stradale e architettonica.
Gruppo ottico	ASP/ASC: Ottica asimmetrica per proiezione. STE-M/S: Ottica asimmetrica per illuminazione stradale extraurbana. STU-M/S: Ottica asimmetrica per illuminazione stradale, urbana e ciclopedonale. STW: Ottica asimmetrica per illuminazione di strade larghe e urbane e extraurbane, specifica per asfalti bagnati. S05: Ottica asimmetrica per illuminazione stradale, urbana e aree verdi. Temperatura di colore: 4000K (3000K in opzione) CRI ≥ 70 Classe di sicurezza fotobiologica: EXEMPT GROUP Efficienza sorgente LED: 168 lm/W @ 525mA, T _j =85°C, 4000K
Classe di isolamento	II, I
Grado di protezione	IP66 IK08 totale
Moduli LED	Gruppo ottico rimovibile.
Inclinazione	Vedere sezione disegni dimensionali
Dimensioni	
Peso	
Superficie esposta	
Montaggio	
Cablaggio	Integrato. Rimovibile.
Temp. di esercizio	-40°C / +50°C (525mA) -40°C / +35°C (700mA)
Temp. di stoccaggio	-40°C / +80°C
Norme di riferimento	EN 60598-1, EN 60598-2-3, EN 60598-2-5, EN 62471, EN 55015, EN 61547, EN 61000-3-2, EN 61000-3-3



CARATTERISTICHE ELETTRICHE

Alimentazione	220÷240V 50/60Hz (Tolleranza standard ±10%. Altri voltaggi e tolleranze su richiesta)
Fattore di potenza	>0,9 (a pieno carico)
Connessione rete	Cavo uscente H07RN-F nx1.5mm ² In opzione: connettore esterno M/F IP66/68 per cavi sezione max. 2,5mm ² , Ø max. 14mm
Protez. sovratensioni	Fino a 10kV Con SPD (in opzione) 10kV / 10kV CM/DM
SPD (in opzione)	10kV-10kA, type II, completo di LED di segnalazione e termofusibile per disconnessione del carico a fine vita.
Sistema di controllo (opzioni)	F: Fisso non dimmerabile. DA: Dimmerazione automatica (mezzanotte virtuale) con profilo di default. DAC: Profilo DA custom. FLC: Flusso luminoso costante. DB: Bipotenza con filo pilota. WL: Telecontrollo punto/punto ad onde radio. DALI: Interfaccia di dimmerazione digitale DALI.
Vita gruppo ottico (T_q=25°C, 700mA)	>100.000hr L90B10 >100.000hr L90, TM-21
MATERIALI	
Attacco	Acciaio zincato e verniciato.
Corpo- Dissipatore	Alluminio pressofuso UNI EN1706. Verniciato a polveri.
Vano cablaggio	
Gruppo ottico	Alluminio 99.85% con finitura superficiale realizzata con deposizione sotto vuoto 99.95%. Alluminio classe A+ (DIN EN 16268)
Schermo	Vetro piano temperato sp. 4mm elevata trasparenza.
Pressacavo	Metallico, M20x1,5 – IP68
Guarnizione	Poliuretanic.
Colore	Grafite - Cod. 01

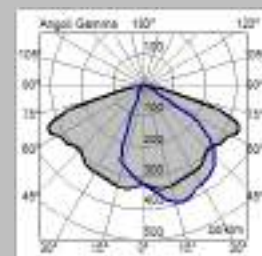

Ottica STE-M

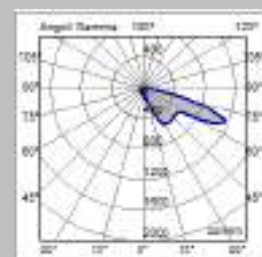

Ottica ASP-7W

Tutti i dati fotometrici pubblicati sono stati rilevati in conformità alle norme UNI EN 13032-1 e IES LM 79-08

GALILEO 1

1 MODULO ASP / ASC

2 MODULI STE / STU / STW / S05

DISEGNI DIMENSIONALI

PESO ESCLUSO STAFFA: 4.3 kg

SUPERFICIE LATERALE: 0.03 m²

SUPERFICIE PIANTA: 0.1 m²

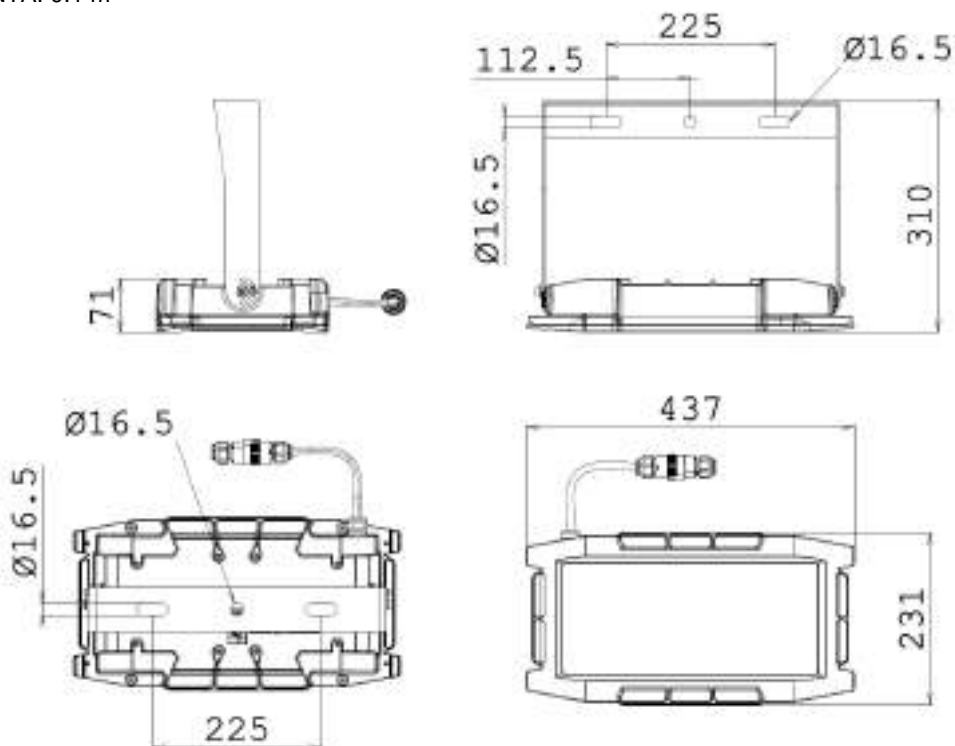

STAFFE DISPONIBILI

STAFFA A - STANDARD

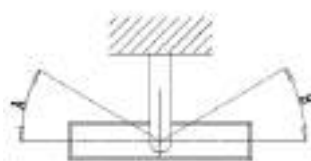

A = 90°
B = 90°

1.6 kg

STAFFA B - OPTIONAL

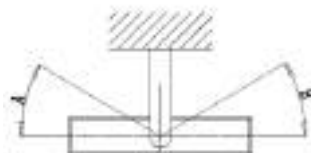

A = 10°
B = 10°

0.6 kg

STAFFA G - OPTIONAL

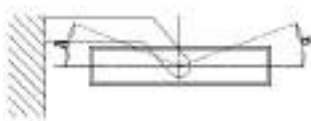

A = 20°
B = 85°

1.3 kg



GALILEO 1

2 / 3 MODULI ASP / ASC

4 / 6 MODULI STE / STU / STW / S05

DISEGNI DIMENSIONALI

PESO ESCLUSO STAFFA: 8.3 kg

SUPERFICIE LATERALE: 0.06 m²

SUPERFICIE PIANTA: 0.1 m²

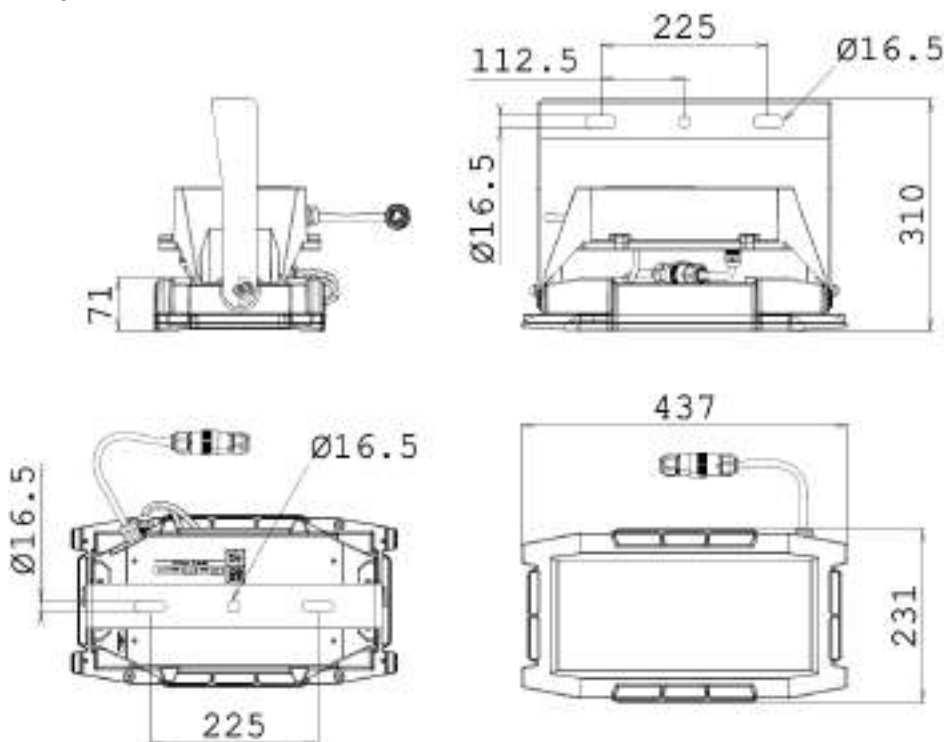

STAFFE DISPONIBILI

STAFFA A - STANDARD

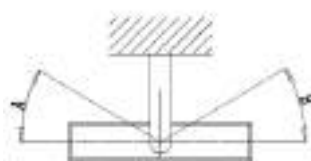

A = 90°
B = 90°

1.6 kg

STAFFA B - OPTIONAL

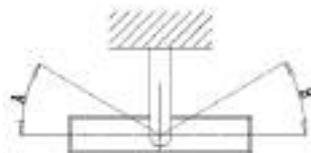

A = 10°
B = 10°

0.6 kg

STAFFA G - OPTIONAL

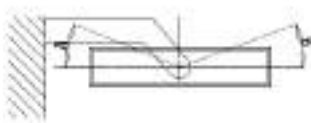

A = 20°
B = 85°

1.3 kg



APPARECCHIO	OTTICA	FLUSSO APPARECCHIO* (Tq=25°C, 4000K, lm)	POTENZA APPARECCHIO* (Tq=25°C, Vin=230Vac, F/DA/DAC, W)	EFFICIENZA APPARECCHIO (Tq=25°C, lm/W)	FLUSSO NOMINALE LED* (Tj=85°C, 4000K, lm)	POTENZA NOMINALE LED* (Tj=85°C, W)
Galileo 1 0F2H1 4.5-2M*	S05	3690	30.5	120	4368	26
Galileo 1 0F2H1 4.5-4M	STU-M	7150	57	125	8736	52
Galileo 1 0F2H1 4.5-6M	STU-S	11110	85	130	13104	78
Galileo 1 0F2H1 4.7-2M*	S05	4720	40	118	5530	36
Galileo 1 0F2H1 4.7-4M	STU-M	8990	76	118	11060	72
Galileo 1 0F2H1 4.7-6M	STU-S	14070	114	123	16590	108
Galileo 1 0F3 4.5-2M*	STE-M	5160	39	132	5900	34
Galileo 1 0F3 4.5-4M	STE-S	9950	76	130	11800	68
Galileo 1 0F3 4.5-6M	STW	15170	112	135	17700	102
Galileo 1 0F3 4.7-2M*	STE-M	6530	52	125	7470	48
Galileo 1 0F3 4.7-4M	STE-S	12550	102	123	14940	96
Galileo 1 0F3 4.7-6M	STW	19040	150	126	22410	144
Galileo 1 0F6 4.5-1M*	ASC-4W	5120	39	131	5901	35
Galileo 1 0F6 4.5-2M	ASP-4N	10080	76	132	11802	70
Galileo 1 0F6 4.5-3M	ASP-4W	15050	112	134	17703	105
Galileo 1 0F6 4.7-1M*	ASC-4W	6410	52	123	7470	47
Galileo 1 0F6 4.7-2M	ASP-4N	12600	102	123	14940	94
Galileo 1 0F6 4.7-3M	ASP-4W	18530	150	123	22410	141
Galileo 1 0F6 4.5-1M*	ASC-5W	5030	39	128	5901	35
Galileo 1 0F6 4.5-2M	ASP-5N	9900	76	130	11802	70
Galileo 1 0F6 4.5-3M	ASP-5W	14770	112	131	17703	105



APPARECCHIO	OTTICA	FLUSSO APPARECCHIO* (Tq=25°C, 4000K, lm)	POTENZA APPARECCHIO* (Tq=25°C, Vin=230Vac, F/DA/DAC, W)	EFFICIENZA APPARECCHIO (Tq=25°C, lm/W)	FLUSSO NOMINALE LED* (Tj=85°C, 4000K, lm)	POTENZA NOMINALE LED* (Tj=85°C, W)
Galileo 1 0F6 4.7-1M*	ASC-5W	6290	52	120	7470	47
Galileo 1 0F6 4.7-2M	ASP-5N	12370	102	121	14940	94
Galileo 1 0F6 4.7-3M	ASP-5W	18190	150	121	22410	141
Galileo 1 0F6 4.5-1M*	ASC-6W	4950	39	126	5901	35
Galileo 1 0F6 4.5-2M	ASP-6N	9760	76	128	11802	70
Galileo 1 0F6 4.5-3M	ASP-6W	14560	112	130	17703	105
Galileo 1 0F6 4.7-1M*	ASC-6W	6210	52	119	7470	47
Galileo 1 0F6 4.7-2M	ASP-6N	12190	102	119	14940	94
Galileo 1 0F6 4.7-3M	ASP-6W	17920	150	119	22410	141
Galileo 1 0F6 4.5-1M*	ASC-7W	4860	39	124	5901	35
Galileo 1 0F6 4.5-2M	ASP-7N	9570	76	125	11802	70
Galileo 1 0F6 4.5-3M	ASP-7W	14340	112	128	17703	105
Galileo 1 0F6 4.7-1M*	ASC-7W	6090	52	117	7470	47
Galileo 1 0F6 4.7-2M	ASP-7N	11960	102	117	14940	94
Galileo 1 0F6 4.7-3M	ASP-7W	17660	150	117	22410	141

*FLUSSO APPARECCHIO / POTENZA APPARECCHIO: Dati nominali rilevati in laboratorio.

*FLUSSO NOMINALE LED / POTENZA NOMINALE LED: Dati nominali estrapolati da datasheet costruttore LED.

I valori indicati in questa scheda tecnica sono da considerarsi valori nominali. Tolleranza su flusso: +/-7%. Tolleranza su potenza: +/-5%.

* Tolleranza su flusso: +/-7%. Tolleranza su potenza: +/-10%.

Al fine di favorire un costante aggiornamento dei propri prodotti, AEC si riserva il diritto di apportare modifiche senza preavviso.



APPARECCHIO	OTTICA	FLUSSO APPARECCHIO* (Tq=25°C, 3000K, lm)	POTENZA APPARECCHIO* (Tq=25°C, Vin=230Vac, F/DA/DAC, W)	EFFICIENZA APPARECCHIO (Tq=25°C, lm/W)	FLUSSO NOMINALE LED* (Tj=85°C, 3000K, lm)	POTENZA NOMINALE LED* (Tj=85°C, W)
Galileo 1 0F2H1 3.5-2M*	S05	3430	30.5	112	3980	26
Galileo 1 0F2H1 3.5-4M	STU-M	6650	57	116	7960	52
Galileo 1 0F2H1 3.5-6M	STU-S	10330	85	121	11940	78
Galileo 1 0F2H1 3.7-2M*	S05	4390	40	109	5040	36
Galileo 1 0F2H1 3.7-4M	STU-M	8360	76	110	10080	72
Galileo 1 0F2H1 3.7-6M	STU-S	13090	114	114	15120	108
Galileo 1 0F3 3.5-2M*	STE-M	4800	39	123	5402	34
Galileo 1 0F3 3.5-4M	STE-S	9250	76	121	10804	68
Galileo 1 0F3 3.5-6M	STW	14110	112	125	16206	102
Galileo 1 0F3 3.7-2M*	STE-M	6070	52	116	6840	48
Galileo 1 0F3 3.7-4M	STE-S	11670	102	114	13680	96
Galileo 1 0F3 3.7-6M	STW	17710	150	118	20520	144
Galileo 1 0F6 3.5-1M*	ASC-4W	4760	39	122	5190	35
Galileo 1 0F6 3.5-2M	ASP-4N	9370	76	123	10380	70
Galileo 1 0F6 3.5-3M	ASP-4W	14000	112	125	15570	105
Galileo 1 0F6 3.7-1M*	ASC-4W	5960	52	114	6570	47
Galileo 1 0F6 3.7-2M	ASP-4N	11720	102	114	13140	94
Galileo 1 0F6 3.7-3M	ASP-4W	17230	150	114	19710	141
Galileo 1 0F6 3.5-1M*	ASC-5W	4680	39	120	5190	35
Galileo 1 0F6 3.5-2M	ASP-5N	9210	76	121	10380	70
Galileo 1 0F6 3.5-3M	ASP-5W	13740	112	122	15570	105

APPARECCHIO	OTTICA	FLUSSO APPARECCHIO* (Tq=25°C, 3000K, lm)	POTENZA APPARECCHIO* (Tq=25°C, Vin=230Vac, F/DA/DAC, W)	EFFICIENZA APPARECCHIO (Tq=25°C, lm/W)	FLUSSO NOMINALE LED* (Tj=85°C, 3000K, lm)	POTENZA NOMINALE LED* (Tj=85°C, W)
Galileo 1 0F6 3.7-1M*	ASC-5W	5850	52	112	6570	47
Galileo 1 0F6 3.7-2M	ASP-5N	11500	102	112	13140	94
Galileo 1 0F6 3.7-3M	ASP-5W	16920	150	112	19710	141
Galileo 1 0F6 3.5-1M*	ASC-6W	4600	39	117	5190	35
Galileo 1 0F6 3.5-2M	ASP-6N	9080	76	119	10380	70
Galileo 1 0F6 3.5-3M	ASP-6W	13540	112	120	15570	105
Galileo 1 0F6 3.7-1M*	ASC-6W	5780	52	111	6570	47
Galileo 1 0F6 3.7-2M	ASP-6N	11340	102	111	13140	94
Galileo 1 0F6 3.7-3M	ASP-6W	16670	150	111	19710	141
Galileo 1 0F6 3.5-1M*	ASC-7W	4520	39	115	5190	35
Galileo 1 0F6 3.5-2M	ASP-7N	8900	76	117	10380	70
Galileo 1 0F6 3.5-3M	ASP-7W	13340	112	119	15570	105
Galileo 1 0F6 3.7-1M*	ASC-7W	5660	52	108	6570	47
Galileo 1 0F6 3.7-2M	ASP-7N	11120	102	109	13140	94
Galileo 1 0F6 3.7-3M	ASP-7W	16420	150	109	19710	141

*FLUSSO APPARECCHIO / POTENZA APPARECCHIO: Dati nominali rilevati in laboratorio.

*FLUSSO NOMINALE LED / POTENZA NOMINALE LED: Dati nominali estrapolati da datasheet costruttore LED.

I valori indicati in questa scheda tecnica sono da considerarsi valori nominali. Tolleranza su flusso: +/-7%. Tolleranza su potenza: +/-5%.

* Tolleranza su flusso: +/-7%. Tolleranza su potenza: +/-10%.

Al fine di favorire un costante aggiornamento dei propri prodotti, AEC si riserva il diritto di apportare modifiche senza preavviso.



DICHIARAZIONE DI CONFORMITÀ



AEC ILLUMINAZIONE S.r.l.

MADE IN ITALY

Il seguente costruttore

Costruttore: **AEC ILLUMINAZIONE S.r.l.**

Indirizzo: Via A. Righi, 4 - Zona industriale Castelnuovo
52010 Subbiano (AR) - Italia

dichiara qui di seguito che il prodotto

Galileo 1 0F6 ASC-6W 3.7-3M

apparecchio di illuminazione per l'installazione fissa

presenta caratteristiche fotometriche conformi a quanto previsto dalla seguente legge

Regione Veneto - Legge Regionale n° 17 del 7 agosto 2009

Subbiano, 10/11/2022

AEC ILLUMINAZIONE S.r.l.

Photometric Report



Costruttore	AEC ILLUMINAZIONE SRL
Tipo di prodotto	Outdoor Lighting Luminaire
Codice fotometria	Galileo 1 0F6 ASC-6W 3.7-3M
Codice apparecchio	Galileo 1 0F6 ASC-6W 3.7-3M
Numero di riferimento	18-009-1879
Descrizione apparecchio	Galileo 1 0F6 ASC-6W 3.7-3M
Data di rilascio	27-03-2018

Foto del prodotto



Technical manager	Alessio Vagheggi	
--------------------------	------------------	--

Photometric Report



Sommario e Allegati

Sommario	Dati apparecchio	
	Normative di riferimento	
	Condizioni generali	
	Dati fotometrici	
	Lista strumentazione	
Allegati	Dati Generali	X
	Tabella fotometrica delle Intensità (cd/Klm)	X
	Tabella fotometrica delle Intensità (cd)	
	Diagramma Polare	
	Diagramma Cartesiano	
	Valutazione UGR	
	Diagramma Sollner Abbagliamento	
	Flusso Zonale	
	Coefficienti di Utilizzazione	
	Isolux Unitario	
	Isocandele Percentuale	
	Tabella e Diagramma Luminanza	
	Classificazione Strade	X
Classificazione Strade IES TM-15		

DATI APPARECCHIO

Geometria apparecchio	Rettangolare		
Dimensioni apparecchio (mm)	Lunghezza / Diametro	Larghezza	Altezza
	231	437	192
Dimensioni area luminosa (mm)	Lunghezza / Diametro	Larghezza	Altezza C0
	120	345	0
	Altezza C90	Altezza C180	Altezza C270
	0	0	0
Tipo sorgente	LED		
Modello sorgente	Luxeon-Mx		
Tipo Alimentatore	Elettronico / Electronic		
Modello Alimentatore	Philips Xi		

NORMATIVE DI RIFERIMENTO

Normative di riferimento	UNI EN 13032-1:2012 UNI EN 13032-4:2015
Valutazione luce parassita	In accordo con Annex A UNI EN 13032-1

CONDIZIONI GENERALI

Condizioni Ambientali	Temperatura ambiente (°C)	25
	Umidità relativa (°RH)	< 60
	Movimento aria (m/s)	< 0.2
Condizioni Elettriche	Tensione di alimentazione (V)	230
	Frequenza di alimentazione (Hz)	50
	Distorsione armonica THD V (%)	< 0.5
Condizioni Preliminari Prova	Tipo di strumento	Goniofotometro
	Sistema di riferimento misura	Sistema C-γ (Gonio) Integrale (Sfera)
	Posizione di misura	In accordo con IES LM-79, EN 13032-1 and 13032-4
	Tempo di stabilizzazione (min)	> 60
	Instabilità sorgente (%)	< 0.5

Photometric Report



DATI FOTOMETRICI

Tipo di dato	Assoluta
LOR (%)	100.0
Flusso luminoso apparecchio (lm)	16670
Potenza ingresso apparecchio (W)	150.0
Efficienza apparecchio (lm/W)	111
Note e commenti	

LISTA STRUMENTAZIONE

CODICE AEC	STRUMENTO	COSTRUTTORE	MODELLO
Q623	Photometer-Unit with photometer head	LMT	SP 30 S0T-1S
Q624	DC Power supply	Keysight	N5751A
Q630	Correction lamp	Labsphere	AUX-1400
Q631	MS/CC Lamp power supply	Labsphere	LPS-525-42
Q634	Power meter	Yokogawa	WT310E
Q636	Weather station + sensors	KIMO	C310-BO + SVS + SHSI
Q654	Weather station + sensors	KIMO	C310-BO + SVS + SHSI
Q657	MS/CC lamp	Labsphere	SCL-1400
Q658	MS/CC lamp	Labsphere	SCL-1400
Q659	MS/CC lamp	Labsphere	SCL-1400

Apparecchio		Rilievo		Lampada	
Codice	Galileo 1 0F6 ASC-6W 3.7-3M	Codice	18-009-1879	Codice	L-GAL1-0F6-3000-700-3M-70-25
Nome	Galileo 1 0F6 ASC-6W 3.7-3M	Nome	Galileo 1 0F6 ASC-6W 3.7-3M	Numero	1
Archivio	Eulumdat	Data	27-03-2018	Posizione	
Flusso Apparecchio	16670.00 lm	Potenza Apparecchio	150.00 W	Efficacia	111.13 lm/W
Flusso Lampade	16670.00 lm	Valore Massimo	802.90 cd/klm	Posizione	C=100.00 G=59.00
Apparecchio Rettangolare	Lung. 231 mm	Larg.	437 mm	Alt.	192 mm
Area Luminosa Rettangolare	Lung. 120 mm	Larg.	345 mm	Alt.	0 mm
Area Luminosa Orizzontale	0.041400 m2	Area Luminosa Piano 180°	0.000000 m2		
Area Luminosa Piano 0°	0.000000 m2	Area Luminosa Piano 270°	0.000000 m2		
Area Luminosa Piano 90°	0.000000 m2	Area Luminosa a 76°	0.010016 m2		
Sistema Coordinate	CG	Tipo di Simmetria	Asimmetrico		
Data	27-03-2018	Massimo Angolo Gamma	180		
Lampade Apparecchio					
Archivio	Codice	Nome	Flusso [lm]	Pot. [W]	Q.tà
	L-GAL1-0F6-3000-700-3M-70-25	L-GAL1-0F6-3000-700-3M-70-25	150.00 W 16670.00	150.00	1
C.I.E.	45 79 98 100 100	D DIN 5040	A30		
F UTE	1.00 E	B NBN	BZ 5 / 1.25 / BZ 4		

231mm x 437mm

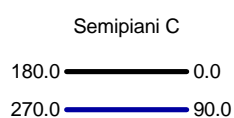
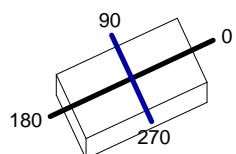

ULOR 0.00 %
DLOR 100.00 %
RN 0.00 %

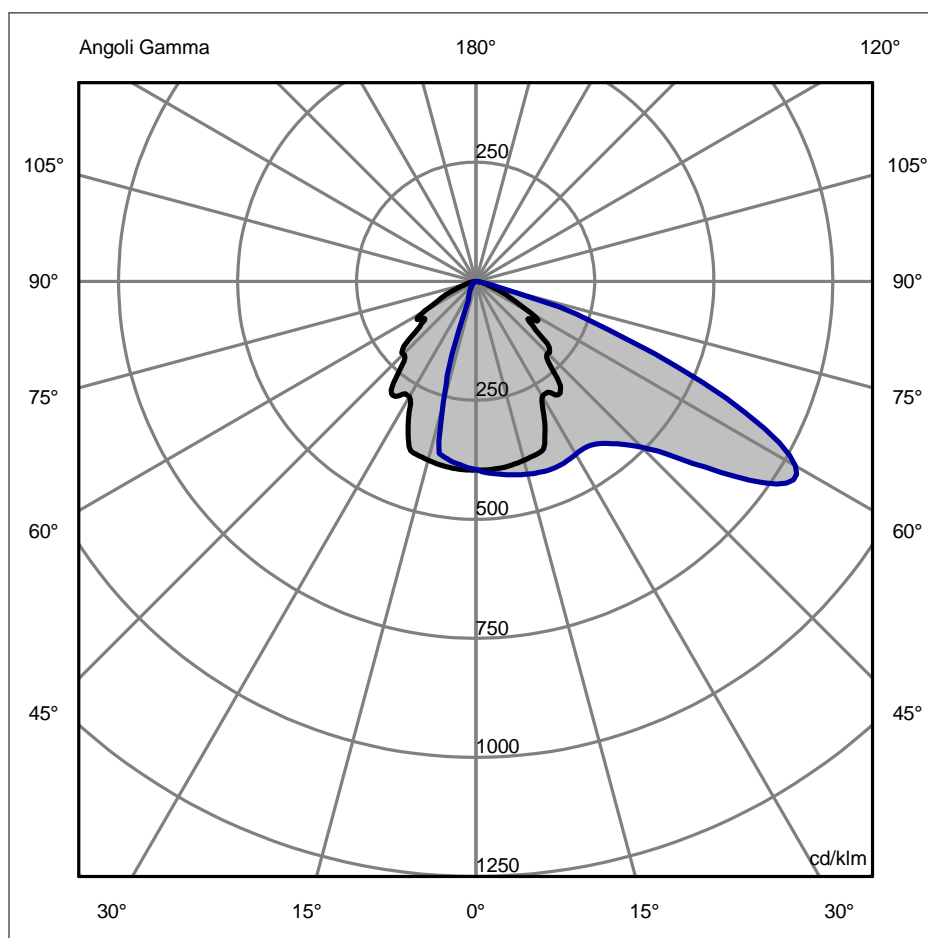

Apparecchio	Rilievo	Lampada
Codice Galileo 1 0F6 ASC-6W 3.7-3M	Codice 18-009-1879	Codice L-GAL1-0F6-3000-700-3M-70-25
Nome Galileo 1 0F6 ASC-6W 3.7-3M	Nome Galileo 1 0F6 ASC-6W 3.7-3M	Numero 1
Archivio Eulumdat	Data 27-03-2018	Posizione

Flusso Apparecchio	16670.00 lm	Potenza Apparecchio	150.00 W	Efficacia	111.13 lm/W	Rendimento	100.00%
Flusso Lampade	16670.00 lm	Valore Massimo	802.90 cd/klm	Posizione	C=100.00 G=59.00	CG	Asimmetrico

Tabella Intensità Luminose - cd/klm Tabella 6/18

	C 325.00	C 330.00	C 335.00	C 340.00	C 345.00	C 350.00	C 355.00
G 0.0	395.67	395.67	395.67	395.67	395.67	395.67	395.67
G 1.0	394.72	394.86	395.13	395.33	395.68	395.92	396.13
G 2.0	393.83	394.02	394.40	394.71	395.15	395.59	395.99
G 3.0	392.87	393.14	393.65	394.11	394.71	395.33	395.94
G 4.0	392.48	392.56	392.93	393.43	394.21	394.98	395.69
G 5.0	391.00	391.76	392.03	392.66	393.57	394.64	395.44
G 6.0	388.85	389.92	391.15	391.76	392.86	394.03	395.01
G 7.0	387.61	388.45	389.71	390.71	391.89	393.27	394.53
G 8.0	386.24	387.10	388.44	389.55	391.02	392.49	393.91
G 9.0	384.10	385.29	387.04	388.37	389.80	391.51	393.20
G 10.0	382.10	383.45	385.45	387.22	388.39	390.47	392.23
G 11.0	380.59	382.40	384.38	385.92	387.76	389.48	391.29
G 12.0	379.33	380.88	382.70	384.26	386.62	388.43	390.28
G 13.0	377.77	379.26	381.40	383.04	385.46	387.23	389.17
G 14.0	375.88	377.72	379.49	381.35	384.36	386.20	387.74
G 15.0	374.41	376.69	378.38	380.07	383.19	385.23	386.86
G 16.0	372.78	375.27	376.93	378.54	381.49	384.24	385.73
G 17.0	370.66	373.17	375.66	377.46	379.91	382.78	384.43
G 18.0	368.26	370.88	373.79	375.82	378.22	380.83	382.89
G 19.0	365.42	368.06	371.80	374.51	376.52	379.55	381.63
G 20.0	362.63	365.75	369.67	372.21	374.52	378.10	380.20
G 21.0	358.32	363.46	366.74	369.93	372.46	376.29	378.64
G 22.0	342.81	360.76	364.41	367.68	370.85	374.22	376.01
G 23.0	316.47	357.94	361.71	364.19	365.26	365.80	368.49
G 24.0	290.13	352.74	356.59	354.88	353.89	350.76	352.71
G 25.0	262.92	330.07	346.64	340.59	336.93	336.27	339.36
G 26.0	235.58	304.59	332.34	325.40	324.69	323.31	326.39
G 27.0	210.99	288.96	317.70	312.44	310.66	310.75	313.65
G 28.0	197.99	243.28	300.43	297.09	296.40	291.18	295.13
G 29.0	169.86	209.84	277.63	281.19	277.20	275.65	280.51
G 30.0	137.99	185.28	246.94	263.90	264.41	266.58	272.17
G 31.0	110.71	170.24	220.15	253.02	257.11	263.74	270.27
G 32.0	84.62	151.71	196.54	248.23	255.21	262.16	269.11
G 33.0	59.59	130.56	181.04	244.64	253.31	260.50	268.19
G 34.0	45.93	108.56	163.54	237.06	252.03	263.41	272.47
G 35.0	41.17	90.33	154.47	228.17	256.71	269.25	280.09
G 36.0	39.98	72.66	150.07	219.50	261.05	271.89	283.65
G 37.0	38.67	55.24	136.74	208.69	260.02	270.83	282.49
G 38.0	37.60	45.70	121.42	194.43	256.67	266.21	276.90
G 39.0	36.51	41.88	102.15	176.39	247.01	257.64	268.82
G 40.0	35.37	40.68	84.76	161.28	235.17	243.23	252.72
G 41.0	34.32	39.35	69.26	147.05	215.58	222.50	230.40
G 42.0	33.27	38.19	57.09	133.08	193.78	201.78	212.85
G 43.0	32.22	37.07	49.03	115.28	171.74	193.72	205.43
G 44.0	31.07	35.78	44.80	98.70	160.98	190.09	202.54
G 45.0	30.04	34.54	41.82	86.55	152.37	188.00	202.16
G 46.0	29.08	33.41	39.61	74.92	143.92	191.93	206.57
G 47.0	27.80	32.22	37.92	63.53	137.04	191.86	204.19
G 48.0	26.95	31.03	36.57	53.18	125.91	186.43	199.83
G 49.0	25.92	29.96	34.99	46.79	118.50	178.25	187.84
G 50.0	25.05	28.89	33.76	43.33	109.00	156.29	167.78
G 51.0	24.13	27.87	32.66	40.95	94.40	137.39	147.91
G 52.0	23.12	26.77	31.53	39.77	85.79	130.36	137.88
G 53.0	22.39	25.87	30.29	37.86	76.33	124.01	128.76
G 54.0	21.56	24.92	29.23	35.34	66.02	116.00	127.26
G 55.0	20.79	24.06	28.08	33.90	54.37	111.14	128.48
G 56.0	20.07	23.14	27.07	32.54	48.65	109.74	134.98
G 57.0	19.48	22.26	26.09	31.22	43.94	110.83	137.24
G 58.0	18.78	21.48	25.19	30.00	40.64	107.61	134.87
G 59.0	18.20	20.72	24.04	28.93	39.30	98.88	130.08
G 60.0	17.59	20.02	23.11	27.45	36.08	85.10	122.62
G 61.0	17.00	19.19	22.22	26.30	33.06	73.99	112.93
G 62.0	16.30	18.53	21.34	25.28	31.30	66.34	104.68
G 63.0	15.83	17.76	20.53	24.08	29.53	56.64	97.88
G 64.0	15.11	17.09	19.50	23.01	28.07	47.99	90.50
G 65.0	14.58	16.38	18.65	21.93	26.45	40.05	82.85
G 66.0	14.00	15.68	17.86	20.86	25.01	33.06	75.01
G 67.0	13.41	14.98	17.02	19.83	23.46	29.51	65.78
G 68.0	12.85	14.31	16.18	18.81	22.16	26.92	57.84
G 69.0	12.20	13.54	15.34	17.71	20.78	25.33	50.09
G 70.0	11.58	12.83	14.45	16.67	19.47	23.69	39.64
G 71.0	10.99	12.07	13.56	15.63	18.37	21.94	34.84
G 72.0	10.28	11.36	12.72	14.52	16.98	20.38	27.76

Apparecchio		Rilievo		Lampada	
Codice	Galileo 1 0F6 ASC-6W 3.7-3M	Codice	18-009-1879	Codice	L-GAL1-0F6-3000-700-3M-70-25
Nome	Galileo 1 0F6 ASC-6W 3.7-3M	Nome	Galileo 1 0F6 ASC-6W 3.7-3M	Numero	1
Archivio	Eulumdat	Data	27-03-2018	Posizione	

Flusso Apparecchio	16670.00 lm	Potenza Apparecchio	150.00 W	Efficacia	111.13 lm/W	Rendimento	100.00%
Flusso Lampade	16670.00 lm	Valore Massimo	802.90 cd/klm	Posizione	C=100.00 G=59.00	CG	Asimmetrico

Tabella Intensità Luminose - cd/klm Tabella 12/18

	C 325.00	C 330.00	C 335.00	C 340.00	C 345.00	C 350.00	C 355.00
G 73.0	9.76	10.64	11.90	13.54	15.77	18.88	24.34
G 74.0	9.03	9.93	10.93	12.48	14.48	17.17	22.92
G 75.0	8.46	9.24	10.10	11.34	13.13	15.66	19.91
G 76.0	7.78	8.56	9.22	10.18	11.90	14.00	17.25
G 77.0	7.13	7.76	8.40	9.42	10.50	12.57	14.78
G 78.0	6.46	7.06	7.58	8.36	9.31	10.80	12.94
G 79.0	5.76	6.31	6.81	7.36	8.07	9.45	11.22
G 80.0	5.00	5.43	5.84	6.48	7.10	8.18	9.47
G 81.0	4.10	4.63	5.13	5.47	6.01	6.88	7.90
G 82.0	3.23	3.78	4.14	4.69	5.02	5.64	6.23
G 83.0	1.91	2.73	3.28	3.70	3.94	4.47	4.78
G 84.0	0.97	1.52	2.14	2.79	2.83	3.23	3.50
G 85.0	0.37	0.63	0.93	1.56	1.75	2.08	2.09
G 86.0	0.07	0.11	0.16	0.33	0.50	0.80	0.89
G 87.0	0.03	0.03	0.03	0.03	0.04	0.05	0.04
G 88.0	0.03	0.03	0.02	0.02	0.02	0.03	0.03
G 89.0	0.03	0.03	0.03	0.02	0.02	0.02	0.02
G 90.0	0.00	0.00	0.00	0.00	0.00	0.00	0.00
G 91.0	0.00	0.00	0.00	0.00	0.00	0.00	0.00
G 92.0	0.00	0.00	0.00	0.00	0.00	0.00	0.00
G 93.0	0.00	0.00	0.00	0.00	0.00	0.00	0.00
G 94.0	0.00	0.00	0.00	0.00	0.00	0.00	0.00
G 95.0	0.00	0.00	0.00	0.00	0.00	0.00	0.00
G 96.0	0.00	0.00	0.00	0.00	0.00	0.00	0.00
G 97.0	0.00	0.00	0.00	0.00	0.00	0.00	0.00
G 98.0	0.00	0.00	0.00	0.00	0.00	0.00	0.00
G 99.0	0.00	0.00	0.00	0.00	0.00	0.00	0.00
G100.0	0.00	0.00	0.00	0.00	0.00	0.00	0.00
G101.0	0.00	0.00	0.00	0.00	0.00	0.00	0.00
G102.0	0.00	0.00	0.00	0.00	0.00	0.00	0.00
G103.0	0.00	0.00	0.00	0.00	0.00	0.00	0.00
G104.0	0.00	0.00	0.00	0.00	0.00	0.00	0.00
G105.0	0.00	0.00	0.00	0.00	0.00	0.00	0.00
G106.0	0.00	0.00	0.00	0.00	0.00	0.00	0.00
G107.0	0.00	0.00	0.00	0.00	0.00	0.00	0.00
G108.0	0.00	0.00	0.00	0.00	0.00	0.00	0.00
G109.0	0.00	0.00	0.00	0.00	0.00	0.00	0.00
G110.0	0.00	0.00	0.00	0.00	0.00	0.00	0.00
G111.0	0.00	0.00	0.00	0.00	0.00	0.00	0.00
G112.0	0.00	0.00	0.00	0.00	0.00	0.00	0.00
G113.0	0.00	0.00	0.00	0.00	0.00	0.00	0.00
G114.0	0.00	0.00	0.00	0.00	0.00	0.00	0.00
G115.0	0.00	0.00	0.00	0.00	0.00	0.00	0.00
G116.0	0.00	0.00	0.00	0.00	0.00	0.00	0.00
G117.0	0.00	0.00	0.00	0.00	0.00	0.00	0.00
G118.0	0.00	0.00	0.00	0.00	0.00	0.00	0.00
G119.0	0.00	0.00	0.00	0.00	0.00	0.00	0.00
G120.0	0.00	0.00	0.00	0.00	0.00	0.00	0.00
G121.0	0.00	0.00	0.00	0.00	0.00	0.00	0.00
G122.0	0.00	0.00	0.00	0.00	0.00	0.00	0.00
G123.0	0.00	0.00	0.00	0.00	0.00	0.00	0.00
G124.0	0.00	0.00	0.00	0.00	0.00	0.00	0.00
G125.0	0.00	0.00	0.00	0.00	0.00	0.00	0.00
G126.0	0.00	0.00	0.00	0.00	0.00	0.00	0.00
G127.0	0.00	0.00	0.00	0.00	0.00	0.00	0.00
G128.0	0.00	0.00	0.00	0.00	0.00	0.00	0.00
G129.0	0.00	0.00	0.00	0.00	0.00	0.00	0.00
G130.0	0.00	0.00	0.00	0.00	0.00	0.00	0.00
G131.0	0.00	0.00	0.00	0.00	0.00	0.00	0.00
G132.0	0.00	0.00	0.00	0.00	0.00	0.00	0.00
G133.0	0.00	0.00	0.00	0.00	0.00	0.00	0.00
G134.0	0.00	0.00	0.00	0.00	0.00	0.00	0.00
G135.0	0.00	0.00	0.00	0.00	0.00	0.00	0.00
G136.0	0.00	0.00	0.00	0.00	0.00	0.00	0.00
G137.0	0.00	0.00	0.00	0.00	0.00	0.00	0.00
G138.0	0.00	0.00	0.00	0.00	0.00	0.00	0.00
G139.0	0.00	0.00	0.00	0.00	0.00	0.00	0.00
G140.0	0.00	0.00	0.00	0.00	0.00	0.00	0.00
G141.0	0.00	0.00	0.00	0.00	0.00	0.00	0.00
G142.0	0.00	0.00	0.00	0.00	0.00	0.00	0.00
G143.0	0.00	0.00	0.00	0.00	0.00	0.00	0.00
G144.0	0.00	0.00	0.00	0.00	0.00	0.00	0.00
G145.0	0.00	0.00	0.00	0.00	0.00	0.00	0.00

Apparecchio		Rilievo		Lampada	
Codice	Galileo 1 0F6 ASC-6W 3.7-3M	Codice	18-009-1879	Codice	L-GAL1-0F6-3000-700-3M-70-25
Nome	Galileo 1 0F6 ASC-6W 3.7-3M	Nome	Galileo 1 0F6 ASC-6W 3.7-3M	Numero	1
Archivio	Eulumdat	Data	27-03-2018	Posizione	

Flusso Apparecchio	16670.00 lm	Potenza Apparecchio	150.00 W	Efficacia	111.13 lm/W	Rendimento	100.00%
Flusso Lampade	16670.00 lm	Valore Massimo	802.90 cd/klm	Posizione	C=100.00 G=59.00	CG	Asimmetrico

Tabella Intensità Luminose - cd/klm Tabella 13/18

	C 0.00	C 5.00	C 10.00	C 15.00	C 20.00	C 25.00	C 30.00	C 35.00	C 40.00	C 45.00	C 50.00	C 55.00	C 60.00
G146.0	0.00	0.00	0.00	0.00	0.00	0.00	0.00	0.00	0.00	0.00	0.00	0.00	0.00
G147.0	0.00	0.00	0.00	0.00	0.00	0.00	0.00	0.00	0.00	0.00	0.00	0.00	0.00
G148.0	0.00	0.00	0.00	0.00	0.00	0.00	0.00	0.00	0.00	0.00	0.00	0.00	0.00
G149.0	0.00	0.00	0.00	0.00	0.00	0.00	0.00	0.00	0.00	0.00	0.00	0.00	0.00
G150.0	0.00	0.00	0.00	0.00	0.00	0.00	0.00	0.00	0.00	0.00	0.00	0.00	0.00
G151.0	0.00	0.00	0.00	0.00	0.00	0.00	0.00	0.00	0.00	0.00	0.00	0.00	0.00
G152.0	0.00	0.00	0.00	0.00	0.00	0.00	0.00	0.00	0.00	0.00	0.00	0.00	0.00
G153.0	0.00	0.00	0.00	0.00	0.00	0.00	0.00	0.00	0.00	0.00	0.00	0.00	0.00
G154.0	0.00	0.00	0.00	0.00	0.00	0.00	0.00	0.00	0.00	0.00	0.00	0.00	0.00
G155.0	0.00	0.00	0.00	0.00	0.00	0.00	0.00	0.00	0.00	0.00	0.00	0.00	0.00
G156.0	0.00	0.00	0.00	0.00	0.00	0.00	0.00	0.00	0.00	0.00	0.00	0.00	0.00
G157.0	0.00	0.00	0.00	0.00	0.00	0.00	0.00	0.00	0.00	0.00	0.00	0.00	0.00
G158.0	0.00	0.00	0.00	0.00	0.00	0.00	0.00	0.00	0.00	0.00	0.00	0.00	0.00
G159.0	0.00	0.00	0.00	0.00	0.00	0.00	0.00	0.00	0.00	0.00	0.00	0.00	0.00
G160.0	0.00	0.00	0.00	0.00	0.00	0.00	0.00	0.00	0.00	0.00	0.00	0.00	0.00
G161.0	0.00	0.00	0.00	0.00	0.00	0.00	0.00	0.00	0.00	0.00	0.00	0.00	0.00
G162.0	0.00	0.00	0.00	0.00	0.00	0.00	0.00	0.00	0.00	0.00	0.00	0.00	0.00
G163.0	0.00	0.00	0.00	0.00	0.00	0.00	0.00	0.00	0.00	0.00	0.00	0.00	0.00
G164.0	0.00	0.00	0.00	0.00	0.00	0.00	0.00	0.00	0.00	0.00	0.00	0.00	0.00
G165.0	0.00	0.00	0.00	0.00	0.00	0.00	0.00	0.00	0.00	0.00	0.00	0.00	0.00
G166.0	0.00	0.00	0.00	0.00	0.00	0.00	0.00	0.00	0.00	0.00	0.00	0.00	0.00
G167.0	0.00	0.00	0.00	0.00	0.00	0.00	0.00	0.00	0.00	0.00	0.00	0.00	0.00
G168.0	0.00	0.00	0.00	0.00	0.00	0.00	0.00	0.00	0.00	0.00	0.00	0.00	0.00
G169.0	0.00	0.00	0.00	0.00	0.00	0.00	0.00	0.00	0.00	0.00	0.00	0.00	0.00
G170.0	0.00	0.00	0.00	0.00	0.00	0.00	0.00	0.00	0.00	0.00	0.00	0.00	0.00
G171.0	0.00	0.00	0.00	0.00	0.00	0.00	0.00	0.00	0.00	0.00	0.00	0.00	0.00
G172.0	0.00	0.00	0.00	0.00	0.00	0.00	0.00	0.00	0.00	0.00	0.00	0.00	0.00
G173.0	0.00	0.00	0.00	0.00	0.00	0.00	0.00	0.00	0.00	0.00	0.00	0.00	0.00
G174.0	0.00	0.00	0.00	0.00	0.00	0.00	0.00	0.00	0.00	0.00	0.00	0.00	0.00
G175.0	0.00	0.00	0.00	0.00	0.00	0.00	0.00	0.00	0.00	0.00	0.00	0.00	0.00
G176.0	0.00	0.00	0.00	0.00	0.00	0.00	0.00	0.00	0.00	0.00	0.00	0.00	0.00
G177.0	0.00	0.00	0.00	0.00	0.00	0.00	0.00	0.00	0.00	0.00	0.00	0.00	0.00
G178.0	0.00	0.00	0.00	0.00	0.00	0.00	0.00	0.00	0.00	0.00	0.00	0.00	0.00
G179.0	0.00	0.00	0.00	0.00	0.00	0.00	0.00	0.00	0.00	0.00	0.00	0.00	0.00
G180.0	0.00	0.00	0.00	0.00	0.00	0.00	0.00	0.00	0.00	0.00	0.00	0.00	0.00

Apparecchio		Rilievo		Lampada	
Codice	Galileo 1 0F6 ASC-6W 3.7-3M	Codice	18-009-1879	Codice	L-GAL1-0F6-3000-700-3M-70-25
Nome	Galileo 1 0F6 ASC-6W 3.7-3M	Nome	Galileo 1 0F6 ASC-6W 3.7-3M	Numero	1
Archivio	Eulumdat	Data	27-03-2018	Posizione	

Flusso Apparecchio	16670.00 lm	Potenza Apparecchio	150.00 W	Efficacia	111.13 lm/W	Rendimento	100.00%
Flusso Lampade	16670.00 lm	Valore Massimo	802.90 cd/klm	Posizione	C=100.00 G=59.00	CG	Asimmetrico

Tabella Intensità Luminose - cd/klm Tabella 14/18

	C 65.00	C 70.00	C 75.00	C 80.00	C 85.00	C 90.00	C 95.00	C 100.00	C 105.00	C 110.00	C 115.00	C 120.00	C 125.00
G146.0	0.00	0.00	0.00	0.00	0.00	0.00	0.00	0.00	0.00	0.00	0.00	0.00	0.00
G147.0	0.00	0.00	0.00	0.00	0.00	0.00	0.00	0.00	0.00	0.00	0.00	0.00	0.00
G148.0	0.00	0.00	0.00	0.00	0.00	0.00	0.00	0.00	0.00	0.00	0.00	0.00	0.00
G149.0	0.00	0.00	0.00	0.00	0.00	0.00	0.00	0.00	0.00	0.00	0.00	0.00	0.00
G150.0	0.00	0.00	0.00	0.00	0.00	0.00	0.00	0.00	0.00	0.00	0.00	0.00	0.00
G151.0	0.00	0.00	0.00	0.00	0.00	0.00	0.00	0.00	0.00	0.00	0.00	0.00	0.00
G152.0	0.00	0.00	0.00	0.00	0.00	0.00	0.00	0.00	0.00	0.00	0.00	0.00	0.00
G153.0	0.00	0.00	0.00	0.00	0.00	0.00	0.00	0.00	0.00	0.00	0.00	0.00	0.00
G154.0	0.00	0.00	0.00	0.00	0.00	0.00	0.00	0.00	0.00	0.00	0.00	0.00	0.00
G155.0	0.00	0.00	0.00	0.00	0.00	0.00	0.00	0.00	0.00	0.00	0.00	0.00	0.00
G156.0	0.00	0.00	0.00	0.00	0.00	0.00	0.00	0.00	0.00	0.00	0.00	0.00	0.00
G157.0	0.00	0.00	0.00	0.00	0.00	0.00	0.00	0.00	0.00	0.00	0.00	0.00	0.00
G158.0	0.00	0.00	0.00	0.00	0.00	0.00	0.00	0.00	0.00	0.00	0.00	0.00	0.00
G159.0	0.00	0.00	0.00	0.00	0.00	0.00	0.00	0.00	0.00	0.00	0.00	0.00	0.00
G160.0	0.00	0.00	0.00	0.00	0.00	0.00	0.00	0.00	0.00	0.00	0.00	0.00	0.00
G161.0	0.00	0.00	0.00	0.00	0.00	0.00	0.00	0.00	0.00	0.00	0.00	0.00	0.00
G162.0	0.00	0.00	0.00	0.00	0.00	0.00	0.00	0.00	0.00	0.00	0.00	0.00	0.00
G163.0	0.00	0.00	0.00	0.00	0.00	0.00	0.00	0.00	0.00	0.00	0.00	0.00	0.00
G164.0	0.00	0.00	0.00	0.00	0.00	0.00	0.00	0.00	0.00	0.00	0.00	0.00	0.00
G165.0	0.00	0.00	0.00	0.00	0.00	0.00	0.00	0.00	0.00	0.00	0.00	0.00	0.00
G166.0	0.00	0.00	0.00	0.00	0.00	0.00	0.00	0.00	0.00	0.00	0.00	0.00	0.00
G167.0	0.00	0.00	0.00	0.00	0.00	0.00	0.00	0.00	0.00	0.00	0.00	0.00	0.00
G168.0	0.00	0.00	0.00	0.00	0.00	0.00	0.00	0.00	0.00	0.00	0.00	0.00	0.00
G169.0	0.00	0.00	0.00	0.00	0.00	0.00	0.00	0.00	0.00	0.00	0.00	0.00	0.00
G170.0	0.00	0.00	0.00	0.00	0.00	0.00	0.00	0.00	0.00	0.00	0.00	0.00	0.00
G171.0	0.00	0.00	0.00	0.00	0.00	0.00	0.00	0.00	0.00	0.00	0.00	0.00	0.00
G172.0	0.00	0.00	0.00	0.00	0.00	0.00	0.00	0.00	0.00	0.00	0.00	0.00	0.00
G173.0	0.00	0.00	0.00	0.00	0.00	0.00	0.00	0.00	0.00	0.00	0.00	0.00	0.00
G174.0	0.00	0.00	0.00	0.00	0.00	0.00	0.00	0.00	0.00	0.00	0.00	0.00	0.00
G175.0	0.00	0.00	0.00	0.00	0.00	0.00	0.00	0.00	0.00	0.00	0.00	0.00	0.00
G176.0	0.00	0.00	0.00	0.00	0.00	0.00	0.00	0.00	0.00	0.00	0.00	0.00	0.00
G177.0	0.00	0.00	0.00	0.00	0.00	0.00	0.00	0.00	0.00	0.00	0.00	0.00	0.00
G178.0	0.00	0.00	0.00	0.00	0.00	0.00	0.00	0.00	0.00	0.00	0.00	0.00	0.00
G179.0	0.00	0.00	0.00	0.00	0.00	0.00	0.00	0.00	0.00	0.00	0.00	0.00	0.00
G180.0	0.00	0.00	0.00	0.00	0.00	0.00	0.00	0.00	0.00	0.00	0.00	0.00	0.00

Apparecchio		Rilievo		Lampada	
Codice	Galileo 1 0F6 ASC-6W 3.7-3M	Codice	18-009-1879	Codice	L-GAL1-0F6-3000-700-3M-70-25
Nome	Galileo 1 0F6 ASC-6W 3.7-3M	Nome	Galileo 1 0F6 ASC-6W 3.7-3M	Numero	1
Archivio	Eulumdat	Data	27-03-2018	Posizione	

Flusso Apparecchio	16670.00 lm	Potenza Apparecchio	150.00 W	Efficacia	111.13 lm/W	Rendimento	100.00%
Flusso Lampade	16670.00 lm	Valore Massimo	802.90 cd/klm	Posizione	C=100.00 G=59.00	CG	Asimmetrico

Tabella Intensità Luminose - cd/klm Tabella 15/18

	C 130.00	C 135.00	C 140.00	C 145.00	C 150.00	C 155.00	C 160.00	C 165.00	C 170.00	C 175.00	C 180.00	C 185.00	C 190.00
G146.0	0.00	0.00	0.00	0.00	0.00	0.00	0.00	0.00	0.00	0.00	0.00	0.00	0.00
G147.0	0.00	0.00	0.00	0.00	0.00	0.00	0.00	0.00	0.00	0.00	0.00	0.00	0.00
G148.0	0.00	0.00	0.00	0.00	0.00	0.00	0.00	0.00	0.00	0.00	0.00	0.00	0.00
G149.0	0.00	0.00	0.00	0.00	0.00	0.00	0.00	0.00	0.00	0.00	0.00	0.00	0.00
G150.0	0.00	0.00	0.00	0.00	0.00	0.00	0.00	0.00	0.00	0.00	0.00	0.00	0.00
G151.0	0.00	0.00	0.00	0.00	0.00	0.00	0.00	0.00	0.00	0.00	0.00	0.00	0.00
G152.0	0.00	0.00	0.00	0.00	0.00	0.00	0.00	0.00	0.00	0.00	0.00	0.00	0.00
G153.0	0.00	0.00	0.00	0.00	0.00	0.00	0.00	0.00	0.00	0.00	0.00	0.00	0.00
G154.0	0.00	0.00	0.00	0.00	0.00	0.00	0.00	0.00	0.00	0.00	0.00	0.00	0.00
G155.0	0.00	0.00	0.00	0.00	0.00	0.00	0.00	0.00	0.00	0.00	0.00	0.00	0.00
G156.0	0.00	0.00	0.00	0.00	0.00	0.00	0.00	0.00	0.00	0.00	0.00	0.00	0.00
G157.0	0.00	0.00	0.00	0.00	0.00	0.00	0.00	0.00	0.00	0.00	0.00	0.00	0.00
G158.0	0.00	0.00	0.00	0.00	0.00	0.00	0.00	0.00	0.00	0.00	0.00	0.00	0.00
G159.0	0.00	0.00	0.00	0.00	0.00	0.00	0.00	0.00	0.00	0.00	0.00	0.00	0.00
G160.0	0.00	0.00	0.00	0.00	0.00	0.00	0.00	0.00	0.00	0.00	0.00	0.00	0.00
G161.0	0.00	0.00	0.00	0.00	0.00	0.00	0.00	0.00	0.00	0.00	0.00	0.00	0.00
G162.0	0.00	0.00	0.00	0.00	0.00	0.00	0.00	0.00	0.00	0.00	0.00	0.00	0.00
G163.0	0.00	0.00	0.00	0.00	0.00	0.00	0.00	0.00	0.00	0.00	0.00	0.00	0.00
G164.0	0.00	0.00	0.00	0.00	0.00	0.00	0.00	0.00	0.00	0.00	0.00	0.00	0.00
G165.0	0.00	0.00	0.00	0.00	0.00	0.00	0.00	0.00	0.00	0.00	0.00	0.00	0.00
G166.0	0.00	0.00	0.00	0.00	0.00	0.00	0.00	0.00	0.00	0.00	0.00	0.00	0.00
G167.0	0.00	0.00	0.00	0.00	0.00	0.00	0.00	0.00	0.00	0.00	0.00	0.00	0.00
G168.0	0.00	0.00	0.00	0.00	0.00	0.00	0.00	0.00	0.00	0.00	0.00	0.00	0.00
G169.0	0.00	0.00	0.00	0.00	0.00	0.00	0.00	0.00	0.00	0.00	0.00	0.00	0.00
G170.0	0.00	0.00	0.00	0.00	0.00	0.00	0.00	0.00	0.00	0.00	0.00	0.00	0.00
G171.0	0.00	0.00	0.00	0.00	0.00	0.00	0.00	0.00	0.00	0.00	0.00	0.00	0.00
G172.0	0.00	0.00	0.00	0.00	0.00	0.00	0.00	0.00	0.00	0.00	0.00	0.00	0.00
G173.0	0.00	0.00	0.00	0.00	0.00	0.00	0.00	0.00	0.00	0.00	0.00	0.00	0.00
G174.0	0.00	0.00	0.00	0.00	0.00	0.00	0.00	0.00	0.00	0.00	0.00	0.00	0.00
G175.0	0.00	0.00	0.00	0.00	0.00	0.00	0.00	0.00	0.00	0.00	0.00	0.00	0.00
G176.0	0.00	0.00	0.00	0.00	0.00	0.00	0.00	0.00	0.00	0.00	0.00	0.00	0.00
G177.0	0.00	0.00	0.00	0.00	0.00	0.00	0.00	0.00	0.00	0.00	0.00	0.00	0.00
G178.0	0.00	0.00	0.00	0.00	0.00	0.00	0.00	0.00	0.00	0.00	0.00	0.00	0.00
G179.0	0.00	0.00	0.00	0.00	0.00	0.00	0.00	0.00	0.00	0.00	0.00	0.00	0.00
G180.0	0.00	0.00	0.00	0.00	0.00	0.00	0.00	0.00	0.00	0.00	0.00	0.00	0.00

Apparecchio		Rilievo		Lampada	
Codice	Galileo 1 0F6 ASC-6W 3.7-3M	Codice	18-009-1879	Codice	L-GAL1-0F6-3000-700-3M-70-25
Nome	Galileo 1 0F6 ASC-6W 3.7-3M	Nome	Galileo 1 0F6 ASC-6W 3.7-3M	Numero	1
Archivio	Eulumdat	Data	27-03-2018	Posizione	

Flusso Apparecchio	16670.00 lm	Potenza Apparecchio	150.00 W	Efficacia	111.13 lm/W	Rendimento	100.00%
Flusso Lampade	16670.00 lm	Valore Massimo	802.90 cd/klm	Posizione	C=100.00 G=59.00	CG	Asimmetrico

Tabella Intensità Luminose - cd/klm Tabella 16/18

	C 195.00	C 200.00	C 205.00	C 210.00	C 215.00	C 220.00	C 225.00	C 230.00	C 235.00	C 240.00	C 245.00	C 250.00	C 255.00
G146.0	0.00	0.00	0.00	0.00	0.00	0.00	0.00	0.00	0.00	0.00	0.00	0.00	0.00
G147.0	0.00	0.00	0.00	0.00	0.00	0.00	0.00	0.00	0.00	0.00	0.00	0.00	0.00
G148.0	0.00	0.00	0.00	0.00	0.00	0.00	0.00	0.00	0.00	0.00	0.00	0.00	0.00
G149.0	0.00	0.00	0.00	0.00	0.00	0.00	0.00	0.00	0.00	0.00	0.00	0.00	0.00
G150.0	0.00	0.00	0.00	0.00	0.00	0.00	0.00	0.00	0.00	0.00	0.00	0.00	0.00
G151.0	0.00	0.00	0.00	0.00	0.00	0.00	0.00	0.00	0.00	0.00	0.00	0.00	0.00
G152.0	0.00	0.00	0.00	0.00	0.00	0.00	0.00	0.00	0.00	0.00	0.00	0.00	0.00
G153.0	0.00	0.00	0.00	0.00	0.00	0.00	0.00	0.00	0.00	0.00	0.00	0.00	0.00
G154.0	0.00	0.00	0.00	0.00	0.00	0.00	0.00	0.00	0.00	0.00	0.00	0.00	0.00
G155.0	0.00	0.00	0.00	0.00	0.00	0.00	0.00	0.00	0.00	0.00	0.00	0.00	0.00
G156.0	0.00	0.00	0.00	0.00	0.00	0.00	0.00	0.00	0.00	0.00	0.00	0.00	0.00
G157.0	0.00	0.00	0.00	0.00	0.00	0.00	0.00	0.00	0.00	0.00	0.00	0.00	0.00
G158.0	0.00	0.00	0.00	0.00	0.00	0.00	0.00	0.00	0.00	0.00	0.00	0.00	0.00
G159.0	0.00	0.00	0.00	0.00	0.00	0.00	0.00	0.00	0.00	0.00	0.00	0.00	0.00
G160.0	0.00	0.00	0.00	0.00	0.00	0.00	0.00	0.00	0.00	0.00	0.00	0.00	0.00
G161.0	0.00	0.00	0.00	0.00	0.00	0.00	0.00	0.00	0.00	0.00	0.00	0.00	0.00
G162.0	0.00	0.00	0.00	0.00	0.00	0.00	0.00	0.00	0.00	0.00	0.00	0.00	0.00
G163.0	0.00	0.00	0.00	0.00	0.00	0.00	0.00	0.00	0.00	0.00	0.00	0.00	0.00
G164.0	0.00	0.00	0.00	0.00	0.00	0.00	0.00	0.00	0.00	0.00	0.00	0.00	0.00
G165.0	0.00	0.00	0.00	0.00	0.00	0.00	0.00	0.00	0.00	0.00	0.00	0.00	0.00
G166.0	0.00	0.00	0.00	0.00	0.00	0.00	0.00	0.00	0.00	0.00	0.00	0.00	0.00
G167.0	0.00	0.00	0.00	0.00	0.00	0.00	0.00	0.00	0.00	0.00	0.00	0.00	0.00
G168.0	0.00	0.00	0.00	0.00	0.00	0.00	0.00	0.00	0.00	0.00	0.00	0.00	0.00
G169.0	0.00	0.00	0.00	0.00	0.00	0.00	0.00	0.00	0.00	0.00	0.00	0.00	0.00
G170.0	0.00	0.00	0.00	0.00	0.00	0.00	0.00	0.00	0.00	0.00	0.00	0.00	0.00
G171.0	0.00	0.00	0.00	0.00	0.00	0.00	0.00	0.00	0.00	0.00	0.00	0.00	0.00
G172.0	0.00	0.00	0.00	0.00	0.00	0.00	0.00	0.00	0.00	0.00	0.00	0.00	0.00
G173.0	0.00	0.00	0.00	0.00	0.00	0.00	0.00	0.00	0.00	0.00	0.00	0.00	0.00
G174.0	0.00	0.00	0.00	0.00	0.00	0.00	0.00	0.00	0.00	0.00	0.00	0.00	0.00
G175.0	0.00	0.00	0.00	0.00	0.00	0.00	0.00	0.00	0.00	0.00	0.00	0.00	0.00
G176.0	0.00	0.00	0.00	0.00	0.00	0.00	0.00	0.00	0.00	0.00	0.00	0.00	0.00
G177.0	0.00	0.00	0.00	0.00	0.00	0.00	0.00	0.00	0.00	0.00	0.00	0.00	0.00
G178.0	0.00	0.00	0.00	0.00	0.00	0.00	0.00	0.00	0.00	0.00	0.00	0.00	0.00
G179.0	0.00	0.00	0.00	0.00	0.00	0.00	0.00	0.00	0.00	0.00	0.00	0.00	0.00
G180.0	0.00	0.00	0.00	0.00	0.00	0.00	0.00	0.00	0.00	0.00	0.00	0.00	0.00

Apparecchio		Rilievo		Lampada	
Codice	Galileo 1 0F6 ASC-6W 3.7-3M	Codice	18-009-1879	Codice	L-GAL1-0F6-3000-700-3M-70-25
Nome	Galileo 1 0F6 ASC-6W 3.7-3M	Nome	Galileo 1 0F6 ASC-6W 3.7-3M	Numero	1
Archivio	Eulumdat	Data	27-03-2018	Posizione	

Flusso Apparecchio	16670.00 lm	Potenza Apparecchio	150.00 W	Efficacia	111.13 lm/W	Rendimento	100.00%
Flusso Lampade	16670.00 lm	Valore Massimo	802.90 cd/klm	Posizione	C=100.00 G=59.00	CG	Asimmetrico

Tabella Intensità Luminose - cd/klm Tabella 17/18

	C 260.00	C 265.00	C 270.00	C 275.00	C 280.00	C 285.00	C 290.00	C 295.00	C 300.00	C 305.00	C 310.00	C 315.00	C 320.00
G146.0	0.00	0.00	0.00	0.00	0.00	0.00	0.00	0.00	0.00	0.00	0.00	0.00	0.00
G147.0	0.00	0.00	0.00	0.00	0.00	0.00	0.00	0.00	0.00	0.00	0.00	0.00	0.00
G148.0	0.00	0.00	0.00	0.00	0.00	0.00	0.00	0.00	0.00	0.00	0.00	0.00	0.00
G149.0	0.00	0.00	0.00	0.00	0.00	0.00	0.00	0.00	0.00	0.00	0.00	0.00	0.00
G150.0	0.00	0.00	0.00	0.00	0.00	0.00	0.00	0.00	0.00	0.00	0.00	0.00	0.00
G151.0	0.00	0.00	0.00	0.00	0.00	0.00	0.00	0.00	0.00	0.00	0.00	0.00	0.00
G152.0	0.00	0.00	0.00	0.00	0.00	0.00	0.00	0.00	0.00	0.00	0.00	0.00	0.00
G153.0	0.00	0.00	0.00	0.00	0.00	0.00	0.00	0.00	0.00	0.00	0.00	0.00	0.00
G154.0	0.00	0.00	0.00	0.00	0.00	0.00	0.00	0.00	0.00	0.00	0.00	0.00	0.00
G155.0	0.00	0.00	0.00	0.00	0.00	0.00	0.00	0.00	0.00	0.00	0.00	0.00	0.00
G156.0	0.00	0.00	0.00	0.00	0.00	0.00	0.00	0.00	0.00	0.00	0.00	0.00	0.00
G157.0	0.00	0.00	0.00	0.00	0.00	0.00	0.00	0.00	0.00	0.00	0.00	0.00	0.00
G158.0	0.00	0.00	0.00	0.00	0.00	0.00	0.00	0.00	0.00	0.00	0.00	0.00	0.00
G159.0	0.00	0.00	0.00	0.00	0.00	0.00	0.00	0.00	0.00	0.00	0.00	0.00	0.00
G160.0	0.00	0.00	0.00	0.00	0.00	0.00	0.00	0.00	0.00	0.00	0.00	0.00	0.00
G161.0	0.00	0.00	0.00	0.00	0.00	0.00	0.00	0.00	0.00	0.00	0.00	0.00	0.00
G162.0	0.00	0.00	0.00	0.00	0.00	0.00	0.00	0.00	0.00	0.00	0.00	0.00	0.00
G163.0	0.00	0.00	0.00	0.00	0.00	0.00	0.00	0.00	0.00	0.00	0.00	0.00	0.00
G164.0	0.00	0.00	0.00	0.00	0.00	0.00	0.00	0.00	0.00	0.00	0.00	0.00	0.00
G165.0	0.00	0.00	0.00	0.00	0.00	0.00	0.00	0.00	0.00	0.00	0.00	0.00	0.00
G166.0	0.00	0.00	0.00	0.00	0.00	0.00	0.00	0.00	0.00	0.00	0.00	0.00	0.00
G167.0	0.00	0.00	0.00	0.00	0.00	0.00	0.00	0.00	0.00	0.00	0.00	0.00	0.00
G168.0	0.00	0.00	0.00	0.00	0.00	0.00	0.00	0.00	0.00	0.00	0.00	0.00	0.00
G169.0	0.00	0.00	0.00	0.00	0.00	0.00	0.00	0.00	0.00	0.00	0.00	0.00	0.00
G170.0	0.00	0.00	0.00	0.00	0.00	0.00	0.00	0.00	0.00	0.00	0.00	0.00	0.00
G171.0	0.00	0.00	0.00	0.00	0.00	0.00	0.00	0.00	0.00	0.00	0.00	0.00	0.00
G172.0	0.00	0.00	0.00	0.00	0.00	0.00	0.00	0.00	0.00	0.00	0.00	0.00	0.00
G173.0	0.00	0.00	0.00	0.00	0.00	0.00	0.00	0.00	0.00	0.00	0.00	0.00	0.00
G174.0	0.00	0.00	0.00	0.00	0.00	0.00	0.00	0.00	0.00	0.00	0.00	0.00	0.00
G175.0	0.00	0.00	0.00	0.00	0.00	0.00	0.00	0.00	0.00	0.00	0.00	0.00	0.00
G176.0	0.00	0.00	0.00	0.00	0.00	0.00	0.00	0.00	0.00	0.00	0.00	0.00	0.00
G177.0	0.00	0.00	0.00	0.00	0.00	0.00	0.00	0.00	0.00	0.00	0.00	0.00	0.00
G178.0	0.00	0.00	0.00	0.00	0.00	0.00	0.00	0.00	0.00	0.00	0.00	0.00	0.00
G179.0	0.00	0.00	0.00	0.00	0.00	0.00	0.00	0.00	0.00	0.00	0.00	0.00	0.00
G180.0	0.00	0.00	0.00	0.00	0.00	0.00	0.00	0.00	0.00	0.00	0.00	0.00	0.00

Apparecchio		Rilievo		Lampada	
Codice	Galileo 1 0F6 ASC-6W 3.7-3M	Codice	18-009-1879	Codice	L-GAL1-0F6-3000-700-3M-70-25
Nome	Galileo 1 0F6 ASC-6W 3.7-3M	Nome	Galileo 1 0F6 ASC-6W 3.7-3M	Numero	1
Archivio	Eulumdat	Data	27-03-2018	Posizione	

Flusso Apparecchio	16670.00 lm	Potenza Apparecchio	150.00 W	Efficacia	111.13 lm/W	Rendimento	100.00%
Flusso Lampade	16670.00 lm	Valore Massimo	802.90 cd/klm	Posizione	C=100.00 G=59.00	CG	Asimmetrico

Tabella Intensità Luminose - cd/klm Tabella 18/18

	C 325.00	C 330.00	C 335.00	C 340.00	C 345.00	C 350.00	C 355.00
G146.0	0.00	0.00	0.00	0.00	0.00	0.00	0.00
G147.0	0.00	0.00	0.00	0.00	0.00	0.00	0.00
G148.0	0.00	0.00	0.00	0.00	0.00	0.00	0.00
G149.0	0.00	0.00	0.00	0.00	0.00	0.00	0.00
G150.0	0.00	0.00	0.00	0.00	0.00	0.00	0.00
G151.0	0.00	0.00	0.00	0.00	0.00	0.00	0.00
G152.0	0.00	0.00	0.00	0.00	0.00	0.00	0.00
G153.0	0.00	0.00	0.00	0.00	0.00	0.00	0.00
G154.0	0.00	0.00	0.00	0.00	0.00	0.00	0.00
G155.0	0.00	0.00	0.00	0.00	0.00	0.00	0.00
G156.0	0.00	0.00	0.00	0.00	0.00	0.00	0.00
G157.0	0.00	0.00	0.00	0.00	0.00	0.00	0.00
G158.0	0.00	0.00	0.00	0.00	0.00	0.00	0.00
G159.0	0.00	0.00	0.00	0.00	0.00	0.00	0.00
G160.0	0.00	0.00	0.00	0.00	0.00	0.00	0.00
G161.0	0.00	0.00	0.00	0.00	0.00	0.00	0.00
G162.0	0.00	0.00	0.00	0.00	0.00	0.00	0.00
G163.0	0.00	0.00	0.00	0.00	0.00	0.00	0.00
G164.0	0.00	0.00	0.00	0.00	0.00	0.00	0.00
G165.0	0.00	0.00	0.00	0.00	0.00	0.00	0.00
G166.0	0.00	0.00	0.00	0.00	0.00	0.00	0.00
G167.0	0.00	0.00	0.00	0.00	0.00	0.00	0.00
G168.0	0.00	0.00	0.00	0.00	0.00	0.00	0.00
G169.0	0.00	0.00	0.00	0.00	0.00	0.00	0.00
G170.0	0.00	0.00	0.00	0.00	0.00	0.00	0.00
G171.0	0.00	0.00	0.00	0.00	0.00	0.00	0.00
G172.0	0.00	0.00	0.00	0.00	0.00	0.00	0.00
G173.0	0.00	0.00	0.00	0.00	0.00	0.00	0.00
G174.0	0.00	0.00	0.00	0.00	0.00	0.00	0.00
G175.0	0.00	0.00	0.00	0.00	0.00	0.00	0.00
G176.0	0.00	0.00	0.00	0.00	0.00	0.00	0.00
G177.0	0.00	0.00	0.00	0.00	0.00	0.00	0.00
G178.0	0.00	0.00	0.00	0.00	0.00	0.00	0.00
G179.0	0.00	0.00	0.00	0.00	0.00	0.00	0.00
G180.0	0.00	0.00	0.00	0.00	0.00	0.00	0.00

Apparecchio		Rilievo		Lampada			
Codice	Galileo 1 0F6 ASC-6W 3.7-3M	Codice	18-009-1879	Codice	L-GAL1-0F6-3000-700-3M-70-25		
Nome	Galileo 1 0F6 ASC-6W 3.7-3M	Nome	Galileo 1 0F6 ASC-6W 3.7-3M	Numero	1		
Archivio	Eulumdat	Data	27-03-2018	Posizione			
Flusso Apparecchio	16670.00 lm	Potenza Apparecchio	150.00 W	Efficacia	111.13 lm/W	Rendimento	100.00%
Flusso Lampade	16670.00 lm	Valore Massimo	802.90 cd/klm	Posizione	C=100.00 G=59.00	CG	Asimmetrico

Marciapiede			Strada		
Piano	0	0.00%	Piano	0	0.00%
Piano	-5	4.73%	Piano	5	4.95%
Piano	-10	9.28%	Piano	10	10.04%
Piano	-15	13.34%	Piano	15	15.24%
Piano	-20	15.58%	Piano	20	20.50%
Piano	-25	16.29%	Piano	25	25.83%
Piano	-30	16.81%	Piano	30	31.26%
Piano	-35	17.23%	Piano	35	36.69%
Piano	-40	17.56%	Piano	40	42.20%
Piano	-45	17.83%	Piano	45	47.93%
Piano	-50	18.06%	Piano	50	54.13%
Piano	-55	18.25%	Piano	55	61.20%
Piano	-60	18.41%	Piano	60	68.81%
Piano	-65	18.54%	Piano	65	75.24%
Piano	-70	18.65%	Piano	70	79.07%
Piano	-75	18.72%	Piano	75	80.65%
Piano	-80	18.76%	Piano	80	81.08%
Piano	-85	18.76%	Piano	85	81.21%
Piano	-90	18.76%	Piano	90	81.24%

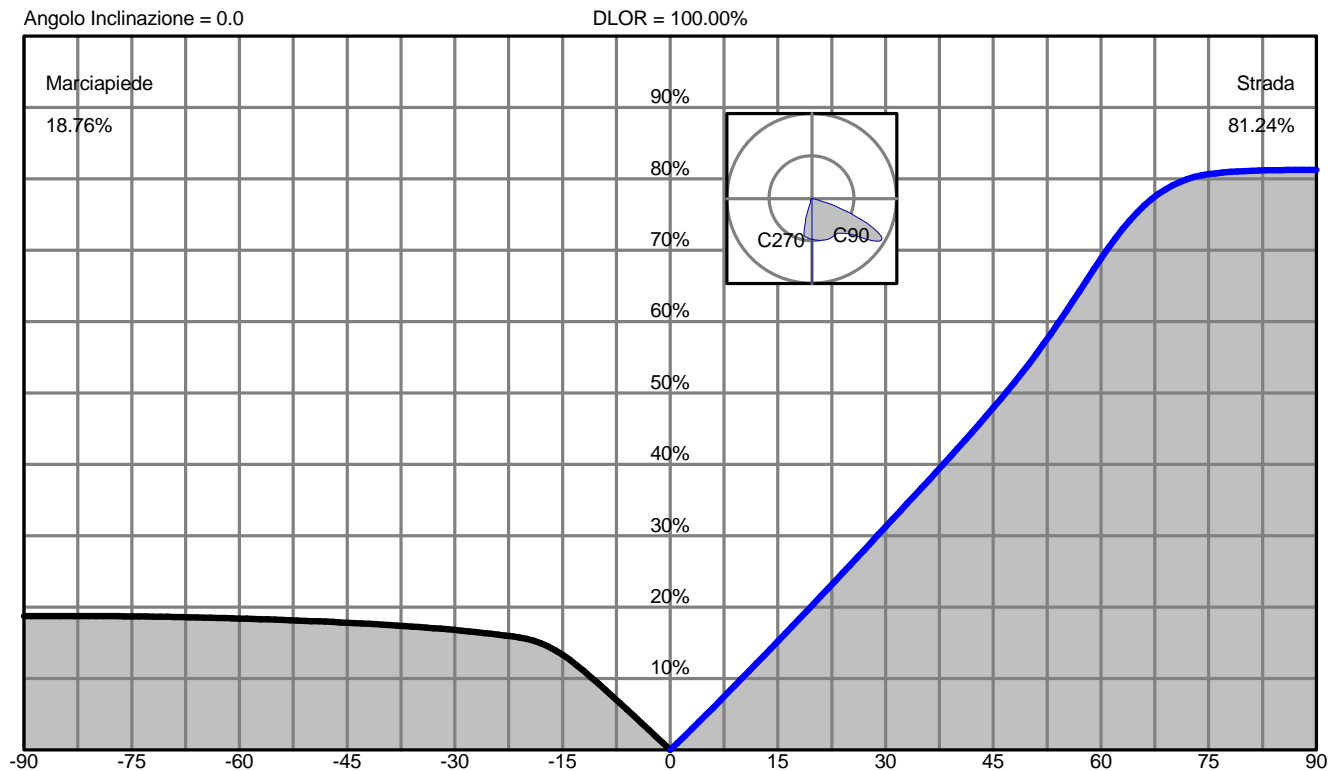

Spread	62.3° Largo	DLOR	100.00000 %
Throw	58.3° Corto	ULOR	0.00000 %
SLI	5.7 Ristretto	Rendimento	100.00000 %
Cutoff CIE	Cutoff - Max: C=100.0° Gamma=59.0°	RN	0.00000 %
Cutoff Iesna	Full Cutoff	Classe Intensità Luminosa	G6
DIN5044	KB1	Indice Abbagliamento	D3
IESNA Type III Very Short Asymmetrical			

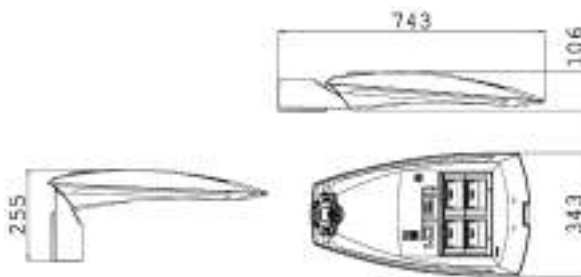

ITALO 1

CARATTERISTICHE PRINCIPALI

Applicazioni	Illuminazione stradale.
Gruppo ottico	<p>STE-M/S: Ottica asimmetrica per illuminazione stradale extraurbana. STU-M/S: Ottica asimmetrica per illuminazione stradale, urbana e ciclopedonale. STW: Ottica asimmetrica per illuminazione di strade larghe e urbane e extraurbane, specifica per asfalti bagnati. SV: Ottica asimmetrica per illuminazione di svincoli autostradali o strade urbane molto strette. OP-DX/SX: Ottica asimmetrica per attraversamenti pedonali. S05: Ottica asimmetrica per illuminazione stradale, urbana e aree verdi.</p> <p>Temperatura di colore: 4000K (3000K in opzione) CRI ≥ 70 LOR= 100%, DLOR= 100%, ULOR= 0% Classe di sicurezza fotobiologica: EXEMPT GROUP Efficienza sorgente LED: 168 lm/W @ 525mA, Tj=85°C, 4000K</p>
Classe di isolamento	II, I
Grado di protezione	IP66 IK09 totale
Moduli LED	Gruppo ottico rimovibile in campo.
Inclinazione	<p>Testa palo: 0°, +5°, +10°, +15°, +20° Braccio: 0°, -5°, -10°, -15°, -20° Braccio: +5°, 0°, -5°, -10°, -15°, -20° (solo Ø33mm ÷ Ø60mm)</p>
Dimensioni	Vedere disegno
Peso	max 7 kg
Superficie esposta	Laterale: 0.06m ² – Pianta: 0.18m ² SCx:0.04m ²
Montaggio	Braccio o testa palo Ø60mm Ø33mm ÷ Ø60mm (in opzione) Ø60mm ÷ Ø76mm (in opzione)
Cablaggio	Piastra cablaggio rimovibile in campo.
Temp. di esercizio	-40°C / +50°C
Temp. di stoccaggio	-40°C / +80°C
Norme di riferimento	EN 60598-1, EN 60598-2-3, EN 62471, EN 55015, EN 61547, EN 61000-3-2, EN 61000-3-3



CARATTERISTICHE ELETTRICHE

Alimentazione	220÷240V 50/60Hz (Tolleranza standard ±10%. Altri voltaggi e tolleranze su richiesta)
Fattore di potenza	>0,95 (a pieno carico, F, DA, DAC)
Sezionatore	Incluso, con ferma cavo integrato.
Connessione rete	Per cavi sezione max. 4mm ²
Protez. sovratensioni	Fino a 10kV Con SPD (in opzione) 10kV / 10kV CM/DM
SPD (in opzione)	10kV-10kA, type II, completo di LED di segnalazione e termofusibile per disconnessione del carico a fine vita.
Sistema di controllo (opzioni)	<p>F: Fisso non dimmerabile. DA: Dimmerazione automatica (mezzanotte virtuale) con profilo di default. DAC: Profilo DA custom. FLC: Flusso luminoso costante. WL: Telecontrollo punto/punto ad onde radio. DALI: Interfaccia di dimmerazione digitale DALI. NEMA: Presa 7 pin (ANSI C136.41). ZHAGA: Presa 4 pin (ZHAGA Book 18).</p>
Vita gruppo ottico (Tq=25°C, 700mA)	>100.000hr L90B10 >100.000hr L90, TM-21

MATERIALI

Attacco	Alluminio pressofuso UNI EN1706. Verniciato a polveri.
Dissipatore	
Telaio	
Copertura	
Gancio di chiusura	Alluminio estruso con molla in acciaio inox.
Gruppo ottico	Alluminio 99.85% con finitura superficiale realizzata con deposizione sotto vuoto 99.95%. (Alluminio classe A+ DIN EN 16268)
Schermo	Vetro piano temperato sp. 4mm elevata trasparenza.
Pressacavo	Plastico M20x1.5 - IP68
Guarnizione	Poliuretana
Colore	Grigio satinato semilucido - Cod. 2B

Profilo DA

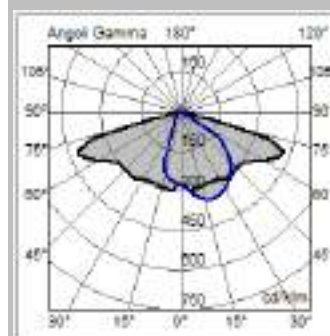
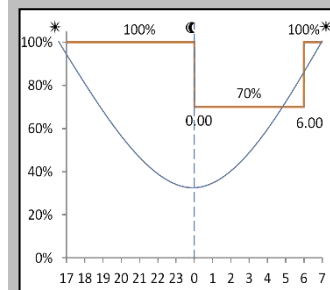

Ottica STU-M

Tutti i dati fotometrici pubblicati sono stati rilevati in conformità alle norme UNI EN 13032-1 e IES LM 79-08





APPARECCHIO	OTTICA	FLUSSO APPARECCHIO* (Tq=25°C, 4000K, lm)	POTENZA APPARECCHIO* (Tq=25°C, Vin=230Vac, F/DA/DAC, W)	EFFICIENZA APPARECCHIO (Tq=25°C, lm/W)	FLUSSO NOMINALE LED* (Tj=85°C, 4000K, lm)	POTENZA NOMINALE LED* (Tj=85°C, W)
ITALO 1 0F2H1 4.5-1M	S05 STU-M STU-S SV	1880	16	117	2184	13
ITALO 1 0F2H1 4.5-2M		3690	30.5	120	4368	26
ITALO 1 0F2H1 4.5-3M		5530	44	125	6552	39
ITALO 1 0F2H1 4.5-4M		7150	57	125	8736	52
ITALO 1 0F2H1 4.7-1M	S05 STU-M STU-S SV	2420	21.5	112	2765	18
ITALO 1 0F2H1 4.7-2M		4720	40	118	5530	36
ITALO 1 0F2H1 4.7-3M		7030	58	121	8295	54
ITALO 1 0F2H1 4.7-4M		8990	76	118	11060	72
ITALO 1 0F3 4.5-1M	STE-M STE-S STW	2610	21.5	121	2950	17
ITALO 1 0F3 4.5-2M		5160	39	132	5900	34
ITALO 1 0F3 4.5-3M		7490	57	131	8850	51
ITALO 1 0F3 4.5-4M		9950	76	130	11800	68
ITALO 1 0F3 4.7-1M	STE-M STE-S STW	3270	28	116	3735	24
ITALO 1 0F3 4.7-2M		6530	52	125	7470	48
ITALO 1 0F3 4.7-3M		9420	76	123	11205	72
ITALO 1 0F3 4.7-4M		12550	102	123	14940	96
ITALO 1 0F6 4.5-1M	OP-DX	5160	39	132	5901	35
ITALO 1 0F6 4.5-2M	OP-SX	9950	76	130	11802	70
ITALO 1 0F6 4.7-1M	OP-DX	6530	52	125	7470	47
ITALO 1 0F6 4.7-2M	OP-SX	12550	102	123	14940	94

*FLUSSO APPARECCHIO / POTENZA APPARECCHIO: Dati nominali rilevati in laboratorio.

*FLUSSO NOMINALE LED / POTENZA NOMINALE LED: Dati nominali estrapolati da datasheet costruttore LED.

I valori indicati in questa scheda tecnica sono da considerarsi valori nominali. Tolleranza su flusso: +/-7%. Tolleranza su potenza: +/-5%.

Tolleranza su potenza in versioni ZHAGA o con alimentatore D4i/SR: +/-10%.

Al fine di favorire un costante aggiornamento dei propri prodotti, AEC si riserva il diritto di apportare modifiche senza preavviso.



APPARECCHIO	OTTICA	FLUSSO APPARECCHIO* (Tq=25°C, 3000K, lm)	POTENZA APPARECCHIO* (Tq=25°C, Vin=230Vac, F/DA/DAC, W)	EFFICIENZA APPARECCHIO (Tq=25°C, lm/W)	FLUSSO NOMINALE LED* (Tj=85°C, 3000K, lm)	POTENZA NOMINALE LED* (Tj=85°C, W)
ITALO 1 0F2H1 3.5-1M	S05 STU-M STU-S SV	1750	16	109	1990	13
ITALO 1 0F2H1 3.5-2M		3430	30.5	112	3980	26
ITALO 1 0F2H1 3.5-3M		5140	44	116	5970	39
ITALO 1 0F2H1 3.5-4M		6650	57	116	7960	52
ITALO 1 0F2H1 3.7-1M	S05 STU-M STU-S SV	2250	21.5	104	2520	18
ITALO 1 0F2H1 3.7-2M		4390	40	109	5040	36
ITALO 1 0F2H1 3.7-3M		6540	58	112	7560	54
ITALO 1 0F2H1 3.7-4M		8360	76	110	10080	72
ITALO 1 0F3 3.5-1M	STE-M STE-S STW	2430	21.5	113	2701	17
ITALO 1 0F3 3.5-2M		4800	39	123	5402	34
ITALO 1 0F3 3.5-3M		6970	57	122	8103	51
ITALO 1 0F3 3.5-4M		9250	76	121	10804	68
ITALO 1 0F3 3.7-1M	STE-M STE-S STW	3040	28	108	3420	24
ITALO 1 0F3 3.7-2M		6070	52	116	6840	48
ITALO 1 0F3 3.7-3M		8760	76	115	10260	72
ITALO 1 0F3 3.7-4M		11670	102	114	13680	96
ITALO 1 0F6 3.5-1M	OP-DX	4800	39	123	5190	35
ITALO 1 0F6 3.5-2M	OP-SX	9250	76	121	10380	70
ITALO 1 0F6 3.7-1M	OP-DX	6070	52	116	6570	47
ITALO 1 0F6 3.7-2M	OP-SX	11670	102	114	13140	94

*FLUSSO APPARECCHIO / POTENZA APPARECCHIO: Dati nominali rilevati in laboratorio.

*FLUSSO NOMINALE LED / POTENZA NOMINALE LED: Dati nominali estrapolati da datasheet costruttore LED.

I valori indicati in questa scheda tecnica sono da considerarsi valori nominali. Tolleranza su flusso: +/-7%. Tolleranza su potenza: +/-5%.

Tolleranza su potenza in versioni ZHAGA o con alimentatore D4i/SR: +/-10%.

Al fine di favorire un costante aggiornamento dei propri prodotti, AEC si riserva il diritto di apportare modifiche senza preavviso.



DICHIARAZIONE DI CONFORMITÀ



AEC ILLUMINAZIONE S.r.l.



Il seguente costruttore

Costruttore: **AEC ILLUMINAZIONE S.r.l.**

Indirizzo: Via A. Righi, 4 - Zona industriale Castelnuovo
52010 Subbiano (AR) - Italia

dichiara qui di seguito che il prodotto

ITALO 1 0F6 OP-DX 3.5-2M

apparecchio di illuminazione per l'installazione fissa

presenta caratteristiche fotometriche conformi a quanto previsto dalla seguente legge

Regione Veneto - Legge Regionale n° 17 del 7 agosto 2009

Subbiano, 10/11/2022

AEC ILLUMINAZIONE S.r.l.



DICHIARAZIONE DI CONFORMITÀ



AEC ILLUMINAZIONE S.r.l.



Il seguente costruttore

Costruttore: **AEC ILLUMINAZIONE S.r.l.**

Indirizzo: Via A. Righi, 4 - Zona industriale Castelnuovo
52010 Subbiano (AR) - Italia

dichiara qui di seguito che il prodotto

ITALO 1 0F6 OP-SX 3.5-1M

apparecchio di illuminazione per l'installazione fissa

presenta caratteristiche fotometriche conformi a quanto previsto dalla seguente legge

Regione Veneto - Legge Regionale n° 17 del 7 agosto 2009

Subbiano, 15/04/2022

AEC ILLUMINAZIONE S.r.l.



DICHIARAZIONE DI CONFORMITÀ



AEC ILLUMINAZIONE S.r.l.

MADE IN ITALY

Il seguente costruttore

Costruttore: **AEC ILLUMINAZIONE S.r.l.**

Indirizzo: Via A. Righi, 4 - Zona industriale Castelnuovo
52010 Subbiano (AR) - Italia

dichiara qui di seguito che il prodotto

ITALO 1 0F6 OP-DX 3.5-1M

apparecchio di illuminazione per l'installazione fissa

presenta caratteristiche fotometriche conformi a quanto previsto dalla seguente legge

Regione Veneto - Legge Regionale n° 17 del 7 agosto 2009

Subbiano, 15/04/2022

AEC ILLUMINAZIONE S.r.l.

Photometric Report



Costruttore	AEC ILLUMINAZIONE SRL
Tipo di prodotto	Outdoor Lighting Luminaire
Codice fotometria	ITALO 1 0F6 OP-DX 3.5-2M
Codice apparecchio	ITALO 1 0F6 OP-DX 3.5-2M
Numero di riferimento	18-009_0718
Descrizione apparecchio	ITALO 1 0F6 OP-DX 3.5-2M
Data di rilascio	22-04-2020

Foto del prodotto



Technical manager	Alessio Vagheggi	
--------------------------	------------------	--

Photometric Report



Sommario e Allegati

Sommario	Dati apparecchio	
	Normative di riferimento	
	Condizioni generali	
	Dati fotometrici	
	Lista strumentazione	
Allegati	Dati Generali	X
	Tabella fotometrica delle Intensità (cd/Klm)	X
	Tabella fotometrica delle Intensità (cd)	
	Diagramma Polare	
	Diagramma Cartesiano	
	Valutazione UGR	
	Diagramma Sollner Abbagliamento	
	Flusso Zonale	
	Coefficienti di Utilizzazione	
	Isolux Unitario	
	Isocandele Percentuale	
	Tabella e Diagramma Luminanza	
	Classificazione Strade	X
Classificazione Strade IES TM-15		

Photometric Report



DATI APPARECCHIO

Geometria apparecchio	Rettangolare		
Dimensioni apparecchio (mm)	Lunghezza / Diametro	Larghezza	Altezza
	615	343	115
Dimensioni area luminosa (mm)	Lunghezza / Diametro	Larghezza	Altezza C0
	120	220	0
	Altezza C90	Altezza C180	Altezza C270
	0	0	0
Tipo sorgente	LED		
Modello sorgente	Luxeon-Mx		
Tipo Alimentatore	Elettronico / Electronic		
Modello Alimentatore	Philips Xi		

NORMATIVE DI RIFERIMENTO

Normative di riferimento	UNI EN 13032-1:2012 UNI EN 13032-4:2015
Valutazione luce parassita	In accordo con Annex A UNI EN 13032-1

CONDIZIONI GENERALI

Condizioni Ambientali	Temperatura ambiente (°C)	25
	Umidità relativa (°RH)	< 60
	Movimento aria (m/s)	< 0.2
Condizioni Elettriche	Tensione di alimentazione (V)	230
	Frequenza di alimentazione (Hz)	50
	Distorsione armonica THD V (%)	< 0.5
Condizioni Preliminari Prova	Tipo di strumento	Goniofotometro
	Sistema di riferimento misura	Sistema C-γ (Gonio) Integrale (Sfera)
	Posizione di misura	In accordo con IES LM-79, EN 13032-1 and 13032-4
	Tempo di stabilizzazione (min)	> 60
	Instabilità sorgente (%)	< 0.5

Photometric Report



DATI FOTOMETRICI

Tipo di dato	Assoluta
LOR (%)	100.0
Flusso luminoso apparecchio (lm)	9250
Potenza ingresso apparecchio (W)	76.0
Efficienza apparecchio (lm/W)	122
Note e commenti	

LISTA STRUMENTAZIONE

CODICE AEC	STRUMENTO	COSTRUTTORE	MODELLO
Q623	Photometer-Unit with photometer head	LMT	SP 30 S0T-1S
Q624	DC Power supply	Keysight	N5751A
Q630	Correction lamp	Labsphere	AUX-1400
Q631	MS/CC Lamp power supply	Labsphere	LPS-525-42
Q634	Power meter	Yokogawa	WT310E
Q636	Weather station + sensors	KIMO	C310-BO + SVS + SHSI
Q654	Weather station + sensors	KIMO	C310-BO + SVS + SHSI
Q657	MS/CC lamp	Labsphere	SCL-1400
Q658	MS/CC lamp	Labsphere	SCL-1400
Q659	MS/CC lamp	Labsphere	SCL-1400

Apparecchio		Rilievo		Lampada	
Codice	ITALO 1 0F6 OP-DX 3.5-2M	Codice	18-009_0718	Codice	L-IT1-0F6-3000-525-2M-70-25
Nome	ITALO 1 0F6 OP-DX 3.5-2M	Nome	ITALO 1 0F6 OP-DX 3.5-2M	Numero	1
Archivio	Eulumdat	Data	22-04-2020	Posizione	
Flusso Apparecchio	9250.00 lm	Potenza Apparecchio	76.00 W	Efficacia	121.71 lm/W
Flusso Lampade	9250.00 lm	Valore Massimo	781.25 cd/klm	Posizione	C=65.00 G=56.00
Apparecchio Rettangolare	Lung. 615 mm	Larg. 343 mm	Alt. 115 mm		
Area Luminosa Rettangolare	Lung. 120 mm	Larg. 220 mm	Alt. 0 mm		
Area Luminosa Orizzontale	0.026400 m2	Area Luminosa Piano 180°	0.000000 m2		
Area Luminosa Piano 0°	0.000000 m2	Area Luminosa Piano 270°	0.000000 m2		
Area Luminosa Piano 90°	0.000000 m2	Area Luminosa a 76°	0.006387 m2		
Sistema Coordinate	CG	Tipo di Simmetria	Asimmetrico		
Data	22-04-2020	Massimo Angolo Gamma	180		
Lampade Apparecchio					
Archivio	Codice	Nome	Flusso [lm]	Pot. [W]	Q.tà
	L-IT1-0F6-3000-525-2M-70-25	ITALO 1-0F6-3000-525-2M-70-25 - 76.00 W	9250.00	76.00	1
C.I.E.	45 81 99 100 100	D DIN 5040	A30		
F UTE	1.00 F	B NBN	BZ 5 / 1 / BZ 4		

615mm x 343mm

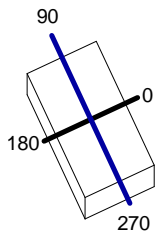

Semipiani C
 180.0 ——— 0.0
 270.0 ——— 90.0

ULOR 0.00 %
 DLOR 100.00 %
 RN 0.00 %

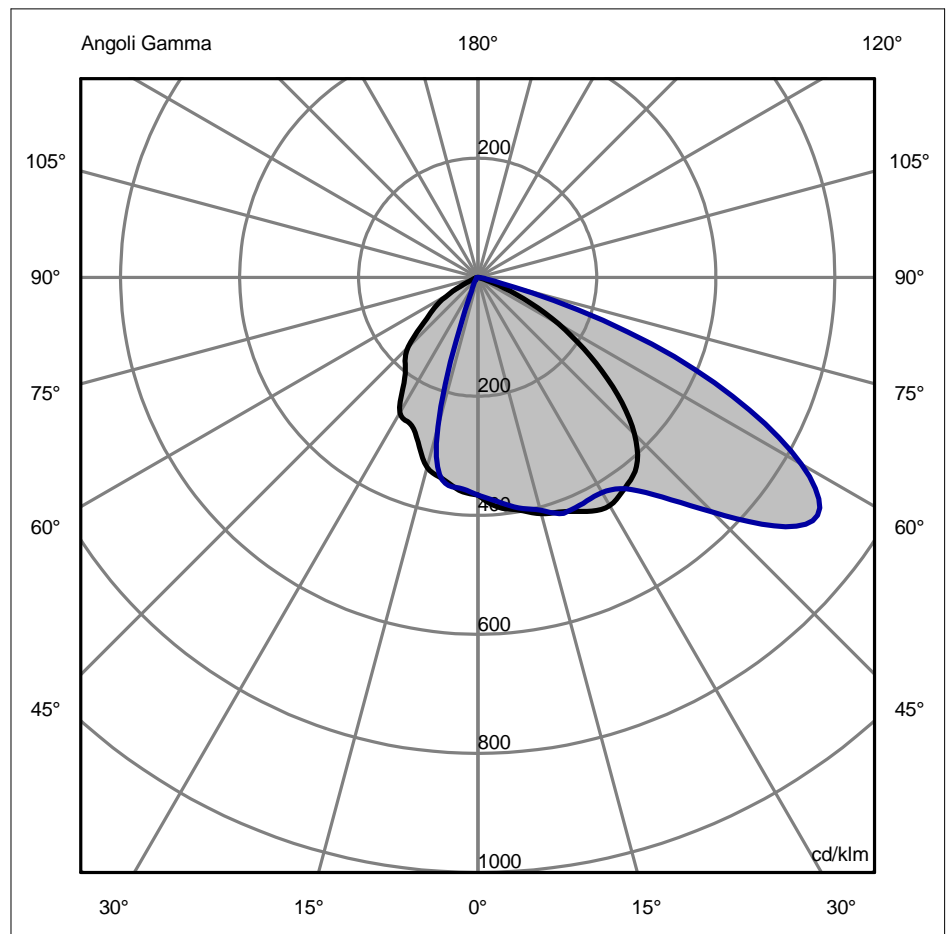

Apparecchio	Rilievo	Lampada
Codice ITALO 1 OF6 OP-DX 3.5-2M	Codice 18-009_0718	Codice L-IT1-OF6-3000-525-2M-70-25
Nome ITALO 1 OF6 OP-DX 3.5-2M	Nome ITALO 1 OF6 OP-DX 3.5-2M	Numero 1
Archivio Eulumatd	Data 22-04-2020	Posizione

Flusso Apparecchio	9250.00 lm	Potenza Apparecchio	76.00 W	Efficacia	121.71 lm/W	Rendimento	100.00%
--------------------	------------	---------------------	---------	-----------	-------------	------------	---------

Flusso Lampade	9250.00 lm	Valore Massimo	781.25 cd/klm	Posizione	C=65.00 G=56.00	CG Asimmetrico
----------------	------------	----------------	---------------	-----------	-----------------	----------------

Tabella Intensità Luminose - cd/klm Tabella 1/18

	C 0.00	C 5.00	C 10.00	C 15.00	C 20.00	C 25.00	C 30.00	C 35.00	C 40.00	C 45.00	C 50.00	C 55.00	C 60.00
G 0.0	365.68	365.68	365.68	365.68	365.68	365.68	365.68	365.68	365.68	365.68	365.68	365.68	365.68
G 1.0	370.69	369.94	369.84	370.14	369.54	369.00	369.64	369.30	367.96	367.66	367.64	368.31	368.34
G 2.0	375.54	374.13	373.92	374.51	373.42	372.39	373.67	372.99	370.47	369.90	369.90	371.03	371.11
G 3.0	380.04	378.18	377.87	378.69	377.34	375.94	377.80	376.81	373.43	372.65	372.71	373.92	374.10
G 4.0	384.01	382.01	381.59	382.59	381.32	379.72	382.11	380.81	377.07	376.16	376.38	377.05	377.42
G 5.0	387.30	385.55	385.03	386.11	385.37	383.81	386.64	385.05	381.62	380.69	381.18	380.51	381.18
G 6.0	389.80	388.77	388.15	389.23	389.50	388.24	391.39	389.58	387.19	386.37	387.24	384.38	385.45
G 7.0	391.74	391.75	391.07	392.15	393.63	392.81	396.17	394.26	393.39	392.82	394.05	388.67	390.21
G 8.0	393.41	394.63	393.97	395.15	397.68	397.32	400.68	398.94	399.74	399.51	400.95	393.42	395.41
G 9.0	395.11	397.55	396.99	398.51	401.54	401.52	404.67	403.48	405.75	405.94	407.27	398.65	400.99
G 10.0	397.14	400.62	400.32	402.50	405.13	405.20	407.87	407.71	410.93	411.59	412.35	404.36	406.89
G 11.0	399.72	403.93	404.05	407.29	408.39	408.20	410.14	411.54	414.94	416.11	415.74	410.53	413.02
G 12.0	402.66	407.35	408.03	412.56	411.41	410.75	411.87	415.12	418.09	419.75	417.96	416.84	419.07
G 13.0	405.70	410.67	412.08	417.92	414.29	413.17	413.58	418.64	420.85	422.91	419.74	422.94	424.68
G 14.0	408.59	413.72	415.98	422.96	417.15	415.76	415.80	422.31	423.66	426.00	421.79	428.45	429.52
G 15.0	411.06	416.31	419.53	427.25	420.11	418.83	419.04	426.34	427.01	429.42	424.87	433.02	433.22
G 16.0	412.93	418.31	422.58	430.51	423.28	422.65	423.69	430.86	431.21	433.49	429.47	436.41	435.58
G 17.0	414.38	419.92	425.17	432.94	426.78	427.21	429.50	435.80	436.08	438.09	435.17	438.87	436.97
G 18.0	415.68	421.38	427.40	434.88	430.72	432.48	436.08	441.03	441.29	443.01	441.35	440.78	437.90
G 19.0	417.10	422.96	429.36	436.64	435.21	438.40	443.04	446.41	446.52	448.04	447.35	442.54	438.88
G 20.0	418.89	424.91	431.14	438.57	440.37	444.91	450.00	451.81	451.43	452.96	452.55	444.53	440.43
G 21.0	421.25	427.42	432.86	440.90	446.21	451.90	456.62	457.12	455.81	457.62	456.49	447.06	442.96
G 22.0	424.08	430.39	434.67	443.61	452.32	458.93	462.76	462.34	459.85	462.07	459.51	450.20	446.42
G 23.0	427.22	433.66	436.73	446.57	458.20	465.47	468.34	467.48	463.83	466.41	462.13	453.94	450.66
G 24.0	430.50	437.07	439.23	449.68	463.33	471.01	473.30	472.57	468.05	470.76	464.89	458.28	455.55
G 25.0	433.75	440.46	442.33	452.83	467.20	475.04	477.53	477.62	472.80	475.20	468.31	463.22	460.92
G 26.0	436.79	443.66	446.10	455.89	469.48	477.23	481.01	482.62	478.27	479.83	472.75	468.70	466.61
G 27.0	439.41	446.49	450.11	458.78	470.50	478.11	483.86	487.34	484.26	484.58	477.99	474.53	472.33
G 28.0	441.42	448.74	453.87	461.37	470.79	478.39	486.25	491.52	490.45	489.39	483.62	480.46	477.75
G 29.0	442.58	450.24	456.86	463.57	470.86	478.79	488.32	494.90	496.53	494.17	489.24	486.25	482.56
G 30.0	442.69	450.80	458.56	465.27	471.23	480.02	490.26	497.23	502.19	498.86	494.47	491.65	488.44
G 31.0	441.63	450.28	458.62	466.36	472.23	482.54	492.16	497.28	507.17	503.37	499.02	496.52	489.24
G 32.0	439.64	448.83	457.40	466.73	473.53	485.76	493.89	497.32	511.35	507.71	503.02	501.03	491.48
G 33.0	437.03	446.65	455.41	466.26	474.60	488.83	495.27	497.37	514.69	511.87	506.75	505.46	493.84
G 34.0	434.14	443.96	453.16	464.81	474.92	490.89	496.10	497.42	517.11	515.84	510.45	510.09	497.01
G 35.0	431.30	440.96	451.18	462.28	473.96	491.08	496.20	497.47	518.56	519.64	514.39	515.19	501.66
G 36.0	428.73	437.80	449.81	458.62	471.38	488.84	495.43	497.81	519.04	523.25	518.76	520.98	508.30
G 37.0	426.15	434.35	448.65	454.13	467.47	484.69	493.82	498.61	518.87	526.64	523.57	527.43	516.65
G 38.0	423.22	430.44	447.16	449.19	462.71	479.42	491.48	499.67	518.40	529.75	528.75	534.47	526.25
G 39.0	419.55	425.90	444.78	444.19	457.57	473.84	488.48	500.79	518.01	532.56	534.23	542.02	536.64
G 40.0	414.79	420.54	440.94	439.51	452.52	468.75	484.93	501.77	518.06	535.00	539.97	550.01	547.36
G 41.0	408.64	414.23	435.22	435.35	447.88	464.72	480.93	502.42	518.84	537.09	545.96	558.38	558.10
G 42.0	401.15	406.96	427.75	431.14	443.33	461.35	476.73	502.64	520.19	539.02	552.50	567.20	569.17
G 43.0	392.44	398.79	418.80	426.16	438.42	458.03	472.56	502.34	521.84	541.02	559.91	576.57	581.00
G 44.0	382.64	389.75	408.63	419.67	432.69	454.13	468.69	501.43	523.54	543.35	568.55	586.59	594.05
G 45.0	371.88	379.89	397.52	410.93	425.68	449.03	465.38	499.81	525.04	546.23	578.77	597.35	608.78
G 46.0	360.28	369.24	385.68	399.45	417.02	442.24	462.73	497.44	526.18	549.90	590.73	608.93	625.42
G 47.0	347.89	357.80	373.20	385.77	406.78	433.87	460.25	494.45	527.18	554.61	603.82	621.28	643.49
G 48.0	334.78	345.59	360.09	370.68	395.13	424.14	457.31	490.99	528.39	560.59	617.29	634.34	662.27
G 49.0	320.99	332.58	346.39	354.97	382.22	413.28	453.27	487.22	530.13	568.07	630.33	648.05	681.06
G 50.0	306.57	318.79	332.14	339.43	368.23	401.53	447.49	483.31	532.74	577.28	642.19	662.35	699.17
G 51.0	291.61	304.25	317.37	324.67	353.36	389.13	439.55	479.38	536.35	588.22	652.24	677.05	715.94
G 52.0	276.27	289.13	302.17	310.53	338.02	376.39	429.89	475.38	540.35	599.80	660.58	691.57	730.90
G 53.0	260.74	273.66	286.67	296.69	322.66	363.64	419.16	471.18	543.91	610.72	667.50	705.18	743.64
G 54.0	245.22	258.05	270.95	282.82	307.73	351.18	408.01	466.70	546.23	619.65	673.25	717.18	753.74
G 55.0	229.89	242.52	255.13	268.59	293.67	339.36	397.08	461.84	546.49	625.27	678.11	726.86	760.79
G 56.0	214.91	227.24	239.31	253.78	280.79	328.36	386.89	456.47	544.04	626.56	682.13	733.50	764.34
G 57.0	200.20	212.19	223.59	238.66	268.81	317.87	377.35	450.44	538.88	623.70	684.47	736.32	763.84
G 58.0	185.67	197.27	208.06	223.59	257.30	307.47	368.23	443.58	531.17	617.15	684.07	734.51	758.73
G 59.0	171.19	182.43	192.81	208.94	245.82	296.71	359.29	435.72	521.06	607.40	679.88	727.30	748.44
G 60.0	156.67	167.58	177.94	195.09	233.94	285.16	350.31	426.69	508.73	594.91	670.84	713.88	732.39
G 61.0	142.03	152.68	163.51	182.28	221.34	272.50	341.01	416.31	494.32	580.00	656.13	693.78	710.25
G 62.0	127.37	137.79	149.45	170.18	208.08	258.84	330.89	404.37	477.89	562.37	635.91	667.73	682.57
G 63.0	112.82	122.98	135.67	158.36	194.34	244.37	319.43	390.64	459.49	541.55	610.57	636.79	650.13
G 64.0	98.54	108.36	122.08	146.38	180.29	229.33	306.08	374.90	439.16	517.06	580.52	602.03	613.70
G 65.0	84.66	94.00	108.58	133.77	166.11	213.90	290.31	356.91	416.96	488.46	546.15	564.50	574.07
G 66.0	71.34	80.02	95.14	120.26	151.94	198.28	271.78	336.53	392.92	455.53	507.94	525.09	531.93
G 67.0	58.80	66.70	81.98	106.17	137.81	182.45	250.99	313.91	367.00	419.13	466.60	484.01	487.71
G 68.0	47.28	54.34	69.37	91.99	123.73	166.40	228.63	289.30	339.18	380.39	422.96	441.30	441.76
G 69.0	37.02	43.22	57.61	78.20	109.73	150.07	205.39	262.92	309.40	340.43	377.79	397.01	394.43
G 70.0	28.24	33.67	46.96	65.28	95.79	133.43	181.97	235.02	277.63	300.37	331.91	351.19	346.05
G 71.0	21.13	25.88	37.66	53.64	82.00	116.53	159.00	205.95	244.04	261.22	286.17	304.11	297.17
G 72.0	15.56	19.73	29.71	43.38	68.67	99.79	136.86	176.58	209.66	223.58	241.63	257.09	249.06



Apparecchio	Rilievo	Lampada
Codice ITALO 1 0F6 OP-DX 3.5-2M	Codice 18-009_0718	Codice L-IT1-0F6-3000-525-2M-70-25
Nome ITALO 1 0F6 OP-DX 3.5-2M	Nome ITALO 1 0F6 OP-DX 3.5-2M	Numero 1
Archivio Eulumdat	Data 22-04-2020	Posizione

Flusso Apparecchio	9250.00 lm	Potenza Apparecchio	76.00 W	Efficacia	121.71 lm/W	Rendimento	100.00%
--------------------	------------	---------------------	---------	-----------	-------------	------------	---------

Flusso Lampade	9250.00 lm	Valore Massimo	781.25 cd/klm	Posizione	C=65.00 G=56.00	CG	Asimmetrico
----------------	------------	----------------	---------------	-----------	-----------------	----	-------------

Tabella Intensità Luminose - cd/klm Tabella 2/18

	C 65.00	C 70.00	C 75.00	C 80.00	C 85.00	C 90.00	C 95.00	C 100.00	C 105.00	C 110.00	C 115.00	C 120.00	C 125.00
G 0.0	365.68	365.68	365.68	365.68	365.68	365.68	365.68	365.68	365.68	365.68	365.68	365.68	365.68
G 1.0	368.57	368.28	367.21	367.37	368.51	367.93	367.89	366.39	366.04	366.46	366.06	366.52	365.70
G 2.0	371.58	371.02	369.00	369.21	371.40	370.23	370.14	367.27	366.63	367.24	366.60	367.37	365.74
G 3.0	374.85	374.03	371.31	371.38	374.39	372.65	372.44	368.45	367.66	368.03	367.45	368.21	365.80
G 4.0	378.51	377.45	374.40	374.03	377.53	375.24	374.81	370.09	369.35	368.81	368.74	369.04	365.90
G 5.0	382.67	381.42	378.53	377.32	380.88	378.05	377.30	372.36	371.93	369.59	370.65	369.86	366.04
G 6.0	387.42	386.02	383.82	381.31	384.43	381.11	379.90	375.31	375.48	372.74	373.23	370.68	366.26
G 7.0	392.56	391.08	389.82	385.76	388.01	384.30	382.53	378.69	379.59	376.49	376.19	371.53	366.69
G 8.0	397.86	396.39	395.92	390.29	391.37	387.48	385.09	382.14	383.70	380.29	379.16	372.46	367.45
G 9.0	403.06	401.72	401.55	394.55	394.30	390.50	387.49	385.31	387.25	383.58	381.75	373.50	368.69
G 10.0	407.94	406.87	406.09	398.18	398.55	393.21	389.62	387.85	389.70	385.85	383.60	374.72	370.55
G 11.0	412.31	411.63	409.15	400.96	398.03	395.52	391.43	389.53	389.76	385.54	383.39	376.10	373.04
G 12.0	416.23	415.96	411.09	403.16	399.14	397.62	393.09	390.57	389.83	385.23	383.17	377.48	375.71
G 13.0	419.83	419.81	412.45	405.18	400.44	399.76	394.81	391.32	389.89	384.92	382.96	378.64	377.94
G 14.0	423.23	423.15	413.80	407.43	402.47	402.19	396.79	392.11	389.95	384.62	382.75	379.37	379.15
G 15.0	426.57	425.95	415.69	410.31	405.78	405.14	399.26	393.30	390.01	384.31	382.53	379.45	378.75
G 16.0	429.94	428.25	418.52	414.09	410.66	408.76	402.33	395.12	391.49	384.62	382.16	378.77	376.39
G 17.0	433.39	430.35	422.11	418.50	416.42	412.71	405.73	397.36	393.73	385.47	381.98	377.54	372.73
G 18.0	436.94	432.62	426.16	423.15	422.13	416.53	409.10	399.74	396.17	386.47	381.80	376.09	368.68
G 19.0	440.60	435.44	430.35	427.64	426.85	419.77	412.07	401.95	398.25	387.24	381.45	374.76	365.13
G 20.0	444.38	439.17	434.35	431.57	429.63	421.98	414.30	403.68	399.38	387.38	380.73	373.84	362.99
G 21.0	448.28	444.01	437.91	434.63	429.88	421.34	414.25	403.80	399.18	386.64	379.55	373.59	362.87
G 22.0	452.14	449.43	441.00	436.90	428.29	420.70	414.21	403.92	397.85	385.29	378.11	373.86	364.13
G 23.0	455.74	454.70	443.62	438.53	425.90	420.06	414.17	404.04	395.80	383.74	376.70	374.43	365.86
G 24.0	458.91	459.10	445.79	439.69	423.73	419.42	414.12	404.17	393.40	382.38	375.62	375.07	367.13
G 25.0	461.43	461.93	447.55	440.55	422.81	418.78	414.08	404.29	391.05	381.61	375.15	375.55	367.00
G 26.0	463.22	462.70	448.90	441.24	423.88	417.68	413.36	404.67	389.09	381.74	375.49	375.67	364.79
G 27.0	464.58	461.97	449.96	441.81	426.43	416.98	412.77	405.05	387.77	382.61	376.42	375.24	360.77
G 28.0	465.93	460.52	450.82	442.29	429.68	416.71	412.34	405.43	387.28	383.97	377.64	374.06	355.44
G 29.0	467.67	459.14	451.57	442.69	432.83	416.91	412.08	405.81	387.81	385.59	378.85	371.96	349.32
G 30.0	470.22	458.63	452.33	443.04	435.07	417.62	412.02	406.20	389.57	387.21	379.75	368.76	342.90
G 31.0	473.86	459.61	453.23	443.42	435.91	418.89	412.23	408.65	392.65	388.64	380.09	364.42	336.66
G 32.0	478.34	462.09	454.48	444.18	436.00	420.92	412.99	411.86	396.74	389.97	379.88	359.47	330.96
G 33.0	483.29	465.92	456.34	445.74	436.28	423.91	414.64	415.61	401.41	391.35	379.19	354.57	326.11
G 34.0	488.33	470.95	459.07	448.50	437.71	428.06	417.51	419.69	406.26	392.92	378.11	350.38	322.44
G 35.0	493.09	477.03	462.91	452.88	441.24	433.58	421.94	423.88	410.86	394.84	376.70	347.58	320.27
G 36.0	497.41	484.03	468.09	459.19	447.58	440.62	428.18	428.07	414.97	397.27	375.10	346.64	319.80
G 37.0	502.03	491.97	474.75	467.41	456.58	449.12	436.16	432.52	418.98	400.36	373.73	347.32	320.75
G 38.0	507.89	500.89	482.97	477.43	467.83	458.94	445.72	437.60	423.46	404.32	373.07	349.16	322.73
G 39.0	515.97	510.85	492.87	489.12	480.96	469.96	456.72	443.65	428.97	409.30	373.60	351.74	325.36
G 40.0	527.20	504.55	502.37	495.57	495.57	482.05	468.99	451.03	436.08	415.51	375.82	354.59	328.24
G 41.0	542.18	534.08	518.09	517.06	511.29	495.12	482.41	460.06	445.24	423.06	380.07	357.45	331.06
G 42.0	560.07	547.57	533.44	533.10	527.82	509.17	496.96	470.84	456.42	431.83	386.26	360.62	333.91
G 43.0	579.66	562.52	550.58	550.38	544.89	524.23	512.64	483.43	469.48	441.64	394.15	364.58	336.94
G 44.0	599.75	579.12	569.43	568.82	562.21	540.35	529.43	497.89	484.27	452.34	403.51	369.80	340.31
G 45.0	619.11	597.52	589.94	588.31	579.51	557.56	547.35	514.27	500.67	463.74	414.12	376.76	344.18
G 46.0	636.87	617.73	611.94	608.67	596.56	575.79	566.28	532.48	518.41	475.67	425.74	385.72	348.67
G 47.0	653.42	639.04	634.67	629.39	613.31	594.63	585.66	551.85	536.74	488.00	438.18	396.20	353.59
G 48.0	669.46	660.56	657.27	649.87	629.79	613.54	604.82	571.53	554.79	500.60	451.25	407.49	358.73
G 49.0	685.72	681.42	678.87	669.51	646.00	632.01	623.10	590.70	571.71	513.34	464.74	418.91	363.86
G 50.0	702.88	700.73	698.59	687.71	661.94	649.52	639.83	608.53	586.62	526.09	478.47	429.77	368.75
G 51.0	721.29	717.72	715.68	703.87	677.44	665.49	654.39	624.22	598.76	538.58	492.08	439.42	373.19
G 52.0	739.69	732.06	729.81	717.38	691.58	679.10	666.40	637.16	607.74	550.06	504.64	447.48	377.10
G 53.0	756.48	743.52	740.78	727.66	703.25	689.49	675.53	646.75	613.25	559.63	515.03	453.60	380.37
G 54.0	770.03	751.89	748.37	734.10	711.34	695.77	681.45	652.44	615.01	566.40	522.15	457.45	382.92
G 55.0	778.71	756.94	752.38	736.09	714.75	697.08	683.82	653.62	612.71	569.46	524.91	458.68	384.68
G 56.0	781.25	758.40	752.56	733.16	712.59	692.79	682.28	649.82	606.16	568.10	522.49	457.01	385.49
G 57.0	777.73	755.86	748.48	725.32	704.94	683.16	676.23	640.93	595.54	562.21	515.21	452.35	384.94
G 58.0	768.61	748.82	739.68	712.70	692.06	668.71	665.06	626.95	581.15	551.86	503.67	444.66	382.56
G 59.0	754.31	736.84	725.69	695.44	674.26	649.96	648.13	607.88	563.26	537.12	488.49	433.88	377.86
G 60.0	735.28	719.43	706.05	673.66	651.81	627.42	624.81	583.70	542.17	518.05	470.27	419.99	370.37
G 61.0	711.91	696.33	680.53	647.58	625.06	601.57	594.89	554.64	518.18	494.85	449.56	403.02	359.73
G 62.0	684.41	668.11	649.82	617.66	594.59	572.78	559.77	521.83	491.63	468.25	426.68	383.33	346.04
G 63.0	652.96	635.55	614.86	584.44	561.03	541.39	521.25	486.62	462.90	439.10	401.89	361.32	329.51
G 64.0	617.72	599.43	576.58	548.49	525.01	507.75	481.16	450.38	432.36	408.25	375.46	337.45	310.35
G 65.0	578.88	560.52	535.90	510.33	487.17	472.19	441.30	414.46	400.38	376.57	347.63	312.13	288.77
G 66.0	536.64	519.46	493.58	470.41	448.02	434.99	403.01	379.83	367.26	344.73	318.66	285.77	265.06
G 67.0	491.40	476.29	449.73	428.75	407.51	396.12	365.74	345.93	333.06	312.65	288.73	258.64	239.73
G 68.0	443.60	430.96	404.24	385.24	365.49	355.47	328.46	311.79	297.77	280.09	257.97	231.00	213.37
G 69.0	393.68	383.35	357.06	339.79	321.79	312.96	290.13	276.47	261.38	246.80	226.55	203.08	186.56
G 70.0	342.08	333.41	308.09	292.32	276.26	268.48	249.75	239.00	223.88	212.53	194.62	175.15	159.88
G 71.0	289.48	281.45	257.66	243.14	229.14	222.35	206.86	199.00	185.56	177.32	162.50	147.53	133.91
G 72.0	237.64	229.51	207.68	194.27	182.37	176.50	163.45	158.33	147.86	142.48	131		



Apparecchio		Rilievo		Lampada	
Codice	ITALO 1 OF6 OP-DX 3.5-2M	Codice	18-009_0718	Codice	L-IT1-OF6-3000-525-2M-70-25
Nome	ITALO 1 OF6 OP-DX 3.5-2M	Nome	ITALO 1 OF6 OP-DX 3.5-2M	Numero	1
Archivio	Eulumdat	Data	22-04-2020	Posizione	

Flusso Apparecchio	9250.00 lm	Potenza Apparecchio	76.00 W	Efficacia	121.71 lm/W	Rendimento	100.00%
Flusso Lampade	9250.00 lm	Valore Massimo	781.25 cd/klm	Posizione	C=65.00 G=56.00	CG	Asimmetrico

Tabella Intensità Luminose - cd/klm Tabella 3/18

	C 130.00	C 135.00	C 140.00	C 145.00	C 150.00	C 155.00	C 160.00	C 165.00	C 170.00	C 175.00	C 180.00	C 185.00	C 190.00
G 0.0	365.68	365.68	365.68	365.68	365.68	365.68	365.68	365.68	365.68	365.68	365.68	365.68	365.68
G 1.0	364.36	364.17	365.54	365.29	365.59	365.41	365.43	364.65	364.82	364.94	364.88	364.66	364.74
G 2.0	363.18	362.79	365.39	364.91	365.36	365.14	365.08	363.59	363.92	364.10	363.94	363.49	363.58
G 3.0	362.26	361.66	365.20	364.52	364.87	364.87	364.50	362.47	362.93	363.07	362.71	362.04	361.99
G 4.0	361.73	360.92	364.97	364.14	363.97	364.60	363.59	361.25	361.79	361.75	361.07	360.16	359.74
G 5.0	361.74	360.70	364.67	363.75	362.54	364.33	362.23	359.90	360.47	360.05	358.85	357.71	356.62
G 6.0	362.36	361.05	364.30	361.99	360.52	362.94	360.38	358.40	358.92	357.91	356.01	354.60	352.52
G 7.0	363.53	361.80	363.87	359.91	358.17	361.23	358.21	356.73	357.14	355.40	352.75	351.02	347.80
G 8.0	365.14	362.70	363.40	357.85	355.83	359.43	356.00	354.92	355.14	352.66	349.36	347.19	342.92
G 9.0	367.07	363.52	362.90	356.17	353.84	357.76	353.98	352.96	352.93	349.79	346.14	343.35	338.37
G 10.0	369.22	363.99	362.40	355.20	352.54	356.44	352.40	350.86	350.51	346.93	343.36	339.73	334.60
G 11.0	371.43	363.96	361.90	355.17	352.32	355.57	351.40	348.60	347.86	344.12	341.19	336.49	331.94
G 12.0	373.43	363.50	361.32	355.14	352.10	354.85	350.57	346.02	344.82	341.13	339.27	333.49	330.01
G 13.0	374.89	362.78	360.58	355.10	351.88	353.83	349.37	342.93	341.19	337.65	337.09	330.50	328.30
G 14.0	375.50	361.94	359.59	355.07	351.66	352.07	347.29	339.15	336.80	333.39	334.17	327.30	326.29
G 15.0	374.95	361.16	358.26	355.04	351.44	349.14	343.79	334.48	331.43	328.03	330.01	323.68	323.46
G 16.0	373.04	360.51	356.51	352.56	349.26	344.75	338.54	328.85	325.02	321.43	324.28	319.44	319.41
G 17.0	370.05	359.76	354.25	348.91	345.87	339.11	332.02	322.56	317.89	314.06	317.32	314.61	314.19
G 18.0	366.40	358.59	351.39	344.47	341.40	332.57	324.89	316.00	310.50	306.55	309.65	309.25	308.00
G 19.0	362.51	356.68	347.85	339.64	335.93	325.50	317.84	309.58	303.26	299.52	301.76	303.40	301.01
G 20.0	358.79	353.73	343.53	334.80	329.59	318.25	311.54	303.70	296.64	293.59	294.17	297.12	293.40
G 21.0	355.54	349.55	338.43	330.25	322.52	311.13	306.47	298.65	290.98	289.22	287.32	290.53	285.41
G 22.0	352.67	344.44	332.79	325.90	315.07	304.32	302.38	294.28	286.27	286.08	281.40	283.94	277.48
G 23.0	349.98	338.87	326.93	321.53	307.60	297.98	298.83	290.32	282.41	283.72	276.55	277.75	270.12
G 24.0	347.28	333.26	321.17	316.97	300.51	292.23	295.40	286.51	279.31	281.63	272.89	272.32	263.82
G 25.0	344.36	328.05	315.82	312.02	294.16	287.24	291.63	282.58	276.87	279.34	270.57	268.03	259.09
G 26.0	341.07	323.59	311.14	306.56	288.86	283.07	287.21	278.33	274.93	276.45	269.53	265.08	256.22
G 27.0	337.40	319.73	307.06	300.89	284.63	279.59	282.30	273.83	273.12	272.88	269.06	262.89	254.65
G 28.0	333.39	316.23	303.47	295.36	281.41	276.60	277.17	269.17	271.00	268.62	268.24	260.72	253.65
G 29.0	329.10	312.86	300.24	290.33	279.14	273.90	272.10	264.49	268.14	263.70	266.19	257.80	252.46
G 30.0	324.54	309.36	297.23	286.18	277.75	271.29	267.37	259.90	264.10	258.11	262.00	253.38	250.33
G 31.0	319.81	305.58	294.34	283.12	277.08	268.54	263.13	255.44	258.59	251.87	255.08	246.92	246.69
G 32.0	315.12	301.71	291.51	280.79	276.51	265.33	259.01	250.84	251.81	245.09	246.09	238.81	241.64
G 33.0	310.72	298.03	288.67	278.68	275.30	261.31	254.53	245.79	244.13	237.86	236.02	229.65	235.49
G 34.0	306.87	294.80	285.79	276.28	272.75	256.14	249.20	239.94	235.88	230.32	225.85	220.03	228.52
G 35.0	303.82	292.31	282.80	273.08	268.11	249.46	242.54	232.95	227.43	222.58	216.53	210.56	221.01
G 36.0	301.79	290.69	279.64	268.68	260.95	241.12	234.26	224.69	219.09	214.76	208.85	201.77	213.26
G 37.0	300.73	289.56	276.18	263.09	251.95	231.76	224.97	215.76	211.16	207.11	202.67	193.93	205.53
G 38.0	300.57	288.39	272.29	256.45	242.08	222.18	215.45	206.97	203.89	199.89	197.65	187.22	198.05
G 39.0	301.22	286.68	267.83	248.87	232.30	213.21	206.51	199.10	197.55	193.35	193.46	181.85	191.07
G 40.0	302.61	283.89	262.65	240.49	223.59	205.66	198.96	192.95	192.39	187.77	189.75	177.99	184.86
G 41.0	304.60	279.71	256.74	231.54	216.65	200.10	193.33	189.01	188.52	183.25	186.19	175.67	179.53
G 42.0	306.83	274.64	250.52	222.65	211.20	196.07	189.15	186.49	185.34	179.33	182.37	174.14	174.81
G 43.0	308.88	269.37	244.55	214.59	206.71	192.86	185.69	184.28	182.11	175.41	177.90	172.51	170.27
G 44.0	310.32	264.58	239.37	208.09	202.63	189.75	182.21	181.28	178.07	170.89	172.38	169.85	165.52
G 45.0	310.75	260.99	235.53	203.91	198.42	186.04	177.98	176.38	172.48	165.14	165.42	165.26	160.16
G 46.0	310.47	259.11	233.38	202.48	193.66	181.19	172.46	168.84	164.84	157.78	156.80	158.12	153.87
G 47.0	310.19	258.87	232.56	202.97	188.44	175.42	165.96	159.42	155.78	149.22	147.04	149.10	146.79
G 48.0	309.91	260.00	232.48	204.23	182.94	169.14	158.98	149.22	146.16	140.05	136.87	139.13	139.17
G 49.0	309.62	262.26	232.59	205.11	177.35	162.74	152.03	139.38	136.86	130.90	126.99	129.18	131.25
G 50.0	309.34	265.40	232.30	204.47	171.88	156.63	145.60	131.01	128.77	122.37	118.12	120.19	123.26
G 51.0	313.72	269.12	231.20	201.49	166.67	151.11	140.04	124.88	122.49	114.94	110.77	112.88	115.38
G 52.0	319.75	272.97	229.41	196.63	161.70	146.04	135.05	120.44	117.56	108.45	104.67	106.97	107.54
G 53.0	326.31	276.47	227.20	190.69	156.92	141.16	130.21	116.79	113.23	102.62	99.35	101.93	99.60
G 54.0	332.24	279.11	224.82	184.47	152.27	136.23	125.05	113.02	108.76	97.16	94.36	97.23	91.43
G 55.0	336.42	280.40	222.54	178.76	147.68	131.01	119.12	108.23	103.42	91.78	89.21	92.36	82.88
G 56.0	337.95	279.97	220.53	174.14	143.09	125.30	112.12	101.76	96.67	86.23	83.53	86.88	73.90
G 57.0	336.82	277.85	218.53	170.35	138.46	119.14	104.24	93.92	88.74	80.38	77.30	80.75	64.66
G 58.0	333.27	274.20	216.22	166.91	133.72	112.63	95.81	85.25	80.08	74.17	70.58	74.05	55.45
G 59.0	327.55	269.18	213.23	163.32	128.82	105.84	87.18	76.29	71.13	67.52	63.44	66.82	46.53
G 60.0	319.90	262.93	209.24	159.12	123.71	98.89	78.66	67.59	62.34	60.35	55.92	59.14	38.16
G 61.0	310.46	255.53	203.92	153.88	118.30	91.83	70.54	59.59	54.07	52.66	48.15	51.10	30.57
G 62.0	299.08	246.70	197.07	147.45	112.39	84.64	62.83	52.27	46.40	44.77	40.40	42.99	23.87
G 63.0	285.49	236.06	188.54	139.74	105.73	77.27	55.51	45.51	39.33	37.06	32.99	35.13	18.14
G 64.0	269.45	223.25	178.15	130.66	98.09	69.69	48.51	39.22	32.84	29.91	26.25	27.84	13.44
G 65.0	250.72	207.90	165.75	120.12	89.21	61.83	41.82	33.26	26.95	23.72	20.49	21.45	9.85
G 66.0	229.22	189.85	151.30	108.17	79.04	53.73	35.43	27.58	21.66	18.77	15.96	16.20	7.39
G 67.0	205.70	169.82	135.40	93.35	68.09	45.66	29.46	22.30	17.02	14.96	12.53	12.04	5.86
G 68.0	181.06	148.74	118.75	82.36	57.08	38.00	24.09	17.60	13.12	12.08	10.01	8.85	5.01
G 69.0	156.24	127.53	102.08	69.89	46.70	31.09	19.47	13.64	10.01	9.92	8.19	6.51	4.58
G 70.0	132.15	107.13	86.11	58.61	37.66	25.30	15.78	10.62	7.76	8.29	6.87	4.90	4.33
G 71.0	109.60	88.32	71.46	49.06	30.47	20.87	13.11	8.63	6.39	6.99	5.87	3.89	4.05
G 72.0	88.95	71.37	58.28	41.08	24.95	17.61	11.28	7.47	5.71	5.96	5.12	3.33	3.72

Apparecchio	Rilievo	Lampada
Codice ITALO 1 OF6 OP-DX 3.5-2M	Codice 18-009_0718	Codice L-IT1-0F6-3000-525-2M-70-25
Nome ITALO 1 OF6 OP-DX 3.5-2M	Nome ITALO 1 OF6 OP-DX 3.5-2M	Numero 1
Archivio Eulumdat	Data 22-04-2020	Posizione

Flusso Apparecchio	9250.00 lm	Potenza Apparecchio	76.00 W	Efficacia	121.71 lm/W	Rendimento	100.00%
--------------------	------------	---------------------	---------	-----------	-------------	------------	---------

Flusso Lampade	9250.00 lm	Valore Massimo	781.25 cd/klm	Posizione	C=65.00 G=56.00	CG	Asimmetrico
----------------	------------	----------------	---------------	-----------	-----------------	----	-------------

Tabella Intensità Luminose - cd/klm Tabella 4/18

	C 195.00	C 200.00	C 205.00	C 210.00	C 215.00	C 220.00	C 225.00	C 230.00	C 235.00	C 240.00	C 245.00	C 250.00	C 255.00
G 0.0	365.68	365.68	365.68	365.68	365.68	365.68	365.68	365.68	365.68	365.68	365.68	365.68	365.68
G 1.0	364.95	363.58	364.09	363.14	362.33	362.04	362.66	363.88	364.83	365.01	364.86	364.48	363.48
G 2.0	363.97	361.39	362.40	360.54	359.07	358.53	359.65	361.95	363.74	364.09	363.90	363.23	361.37
G 3.0	362.48	359.03	360.47	357.81	356.01	355.26	356.64	359.73	362.16	362.69	362.64	361.88	359.43
G 4.0	360.22	356.39	358.19	354.88	353.23	352.36	353.64	357.09	359.83	360.57	360.95	360.37	357.77
G 5.0	356.94	353.39	355.45	351.69	350.83	349.96	350.63	353.87	356.53	357.48	358.68	358.66	356.46
G 6.0	352.52	350.00	352.19	348.21	348.86	348.11	347.66	350.05	352.16	353.33	355.75	356.67	355.51
G 7.0	347.37	346.40	348.62	344.63	347.15	346.65	344.84	346.01	347.29	348.62	352.35	354.30	354.49
G 8.0	342.05	342.83	345.00	341.16	345.45	345.33	342.34	342.22	342.67	344.01	348.76	351.43	352.91
G 9.0	337.13	339.53	341.58	338.01	343.57	343.93	340.31	339.17	339.05	340.15	345.24	347.95	350.26
G 10.0	333.16	336.76	338.62	335.41	341.25	342.20	338.91	337.35	337.14	337.70	342.04	343.74	346.04
G 11.0	330.50	334.64	336.30	333.48	338.36	339.96	338.16	336.93	334.08	336.86	339.11	338.46	339.64
G 12.0	328.77	332.92	334.37	331.99	335.04	337.23	337.49	336.90	331.01	336.00	335.06	330.98	330.08
G 13.0	327.40	331.22	332.48	330.58	331.50	334.06	336.23	335.93	327.94	333.05	328.15	319.95	316.30
G 14.0	325.82	329.19	330.29	328.94	327.97	330.53	333.68	332.68	324.88	325.94	316.66	304.02	297.22
G 15.0	323.46	326.45	327.45	326.72	324.65	326.69	329.16	325.83	321.81	312.60	298.87	281.84	271.76
G 16.0	319.86	322.71	323.70	323.66	321.62	322.46	322.04	314.36	304.46	291.61	273.73	252.72	239.53
G 17.0	315.11	317.96	319.04	319.72	318.30	317.18	312.02	298.41	280.98	264.22	242.82	218.66	202.83
G 18.0	309.40	312.25	313.53	314.95	313.96	310.04	298.86	278.44	252.90	232.32	208.41	182.32	164.65
G 19.0	302.92	305.65	307.26	309.38	307.88	300.21	282.34	254.91	221.74	197.84	172.78	146.35	127.96
G 20.0	295.89	298.20	300.28	303.05	299.31	286.89	262.21	228.25	189.03	162.67	138.17	113.42	95.75
G 21.0	288.52	290.04	292.70	295.92	287.72	269.52	238.45	199.10	156.26	128.61	106.57	85.68	70.33
G 22.0	281.10	281.62	284.67	287.69	273.31	248.56	211.92	168.72	124.73	96.98	78.79	63.20	51.32
G 23.0	273.95	273.48	276.37	277.97	256.45	224.71	183.67	138.55	95.70	68.99	55.33	45.58	37.68
G 24.0	267.37	266.15	267.99	266.40	237.53	198.70	154.76	110.04	70.43	45.84	36.71	32.39	28.36
G 25.0	261.68	260.16	259.70	252.58	216.92	171.24	126.24	84.61	50.19	28.75	23.45	23.21	22.31
G 26.0	257.10	255.86	251.60	236.34	195.03	143.14	99.15	63.41	35.81	25.95	21.66	21.29	18.57
G 27.0	253.43	252.83	243.38	218.21	172.33	115.52	74.35	46.38	26.46	23.16	19.86	19.37	16.50
G 28.0	250.41	250.51	234.66	198.93	149.30	89.64	52.68	33.14	20.89	20.37	18.07	17.44	15.52
G 29.0	247.75	248.29	225.07	179.23	126.44	66.72	34.97	23.33	17.84	17.57	16.28	15.52	15.07
G 30.0	245.17	245.59	214.21	159.85	104.23	47.99	22.08	16.58	16.05	14.78	14.49	13.60	14.60
G 31.0	242.39	241.87	201.80	141.38	83.17	34.32	20.18	15.30	14.49	13.61	13.30	13.17	13.65
G 32.0	239.21	236.82	188.01	123.82	63.84	25.06	18.29	14.02	12.97	12.43	12.12	12.23	12.29
G 33.0	235.41	230.16	173.10	107.04	46.81	19.18	16.39	12.73	11.53	11.26	10.93	10.99	10.73
G 34.0	230.78	221.62	157.33	90.90	32.68	15.66	14.50	11.45	10.21	10.09	9.74	9.65	9.14
G 35.0	225.12	210.95	140.96	75.26	22.03	13.48	12.61	10.17	9.04	8.91	8.56	8.41	7.73
G 36.0	218.28	198.00	124.29	60.11	19.61	11.78	11.55	10.00	8.06	7.74	7.21	7.43	6.64
G 37.0	210.39	183.27	107.62	45.92	17.19	10.37	10.50	9.45	7.23	6.99	6.27	6.69	5.84
G 38.0	201.63	167.35	91.29	33.25	14.77	9.22	9.45	8.67	6.53	6.54	5.66	6.13	5.27
G 39.0	192.19	150.87	75.62	22.70	12.35	8.31	8.40	7.80	5.94	6.23	5.32	5.67	4.86
G 40.0	182.26	134.45	60.96	14.85	9.94	7.60	7.35	6.99	5.41	5.91	5.17	5.26	4.52
G 41.0	172.00	118.60	47.62	13.45	9.69	7.07	6.36	6.36	4.94	5.49	5.15	4.84	4.21
G 42.0	161.49	103.46	35.84	12.05	9.04	6.67	5.77	5.90	4.51	4.97	5.14	4.43	3.92
G 43.0	150.77	89.07	25.83	10.65	8.15	6.34	5.45	5.56	4.14	4.43	5.13	4.05	3.66
G 44.0	139.90	75.48	17.81	9.25	7.17	6.02	5.27	5.29	3.83	3.92	5.11	3.74	3.44
G 45.0	128.93	62.71	12.02	7.85	6.27	5.67	5.10	5.05	3.59	3.51	5.10	3.51	3.27
G 46.0	117.92	50.85	11.10	7.25	5.59	5.25	4.83	4.80	3.43	3.22	4.81	3.38	3.14
G 47.0	106.91	40.10	10.19	6.66	5.10	4.78	4.49	4.55	3.33	3.07	4.42	3.33	3.07
G 48.0	95.95	30.68	9.28	6.06	4.77	4.32	4.15	4.30	3.27	3.02	3.98	3.32	3.02
G 49.0	85.12	22.84	8.37	5.47	4.55	3.92	3.86	4.08	3.26	3.04	3.58	3.33	3.00
G 50.0	74.45	16.79	7.45	4.87	4.41	3.63	3.69	3.89	3.26	3.12	3.28	3.30	2.99
G 51.0	64.02	12.67	7.14	4.84	4.29	3.61	3.68	3.75	3.27	3.24	3.26	3.22	2.99
G 52.0	54.03	10.16	6.84	4.80	4.20	3.59	3.77	3.64	3.29	3.35	3.24	3.10	2.98
G 53.0	44.67	8.83	6.53	4.76	4.15	3.57	3.89	3.55	3.31	3.45	3.23	2.96	2.97
G 54.0	36.15	8.25	6.22	4.73	4.13	3.55	3.98	3.45	3.33	3.49	3.21	2.82	2.94
G 55.0	28.68	8.00	5.91	4.69	4.15	3.53	3.96	3.33	3.35	3.45	3.19	2.72	2.89
G 56.0	22.41	7.72	5.30	4.55	4.20	3.48	3.79	3.17	3.36	3.31	3.08	2.66	2.82
G 57.0	17.30	7.37	4.76	4.41	4.27	3.37	3.51	2.99	3.37	3.11	2.90	2.64	2.74
G 58.0	13.22	6.99	4.30	4.27	4.33	3.23	3.20	2.82	3.37	2.88	2.70	2.62	2.66
G 59.0	10.09	6.59	3.96	4.13	4.36	3.07	2.91	2.69	3.36	2.68	2.50	2.59	2.59
G 60.0	7.79	6.22	3.77	3.98	4.34	2.93	2.73	2.62	3.34	2.53	2.34	2.54	2.55
G 61.0	6.20	5.89	3.74	3.87	4.23	2.81	2.69	2.63	3.30	2.47	2.35	2.43	2.54
G 62.0	5.21	5.59	3.82	3.80	4.06	2.73	2.77	2.69	3.25	2.49	2.36	2.31	2.56
G 63.0	4.66	5.30	3.94	3.74	3.85	2.69	2.89	2.78	3.17	2.53	2.36	2.18	2.58
G 64.0	4.42	5.00	4.04	3.65	3.61	2.71	3.01	2.86	3.05	2.58	2.37	2.09	2.59
G 65.0	4.35	4.68	4.05	3.52	3.37	2.78	3.06	2.91	2.89	2.60	2.38	2.05	2.58
G 66.0	4.32	4.31	3.91	3.32	3.14	2.91	2.99	2.89	2.69	2.56	2.41	2.09	2.52
G 67.0	4.28	3.93	3.67	3.08	2.94	3.08	2.84	2.82	2.47	2.48	2.41	2.16	2.43
G 68.0	4.22	3.57	3.38	2.84	2.79	3.23	2.65	2.72	2.25	2.39	2.39	2.24	2.31
G 69.0	4.08	3.28	3.09	2.63	2.71	3.32	2.45	2.61	2.06	2.29	2.34	2.28	2.17
G 70.0	3.86	3.09	2.86	2.49	2.71	3.33	2.30	2.52	1.93	2.23	2.26	2.23	2.02
G 71.0	3.52	3.08	2.74	2.44	2.81	3.23	2.23	2.46	1.88	2.21	2.16	2.07	1.88
G 72.0	3.12	3.07	2.69	2.46	2.97	3.04	2.22	2.41	1.89	2.21	2.03	1.83	1.74



Apparecchio Codice ITALO 1 0F6 OP-DX 3.5-2M Nome ITALO 1 0F6 OP-DX 3.5-2M Archivio Eulumdat	Rilievo Codice 18-009_0718 Nome ITALO 1 0F6 OP-DX 3.5-2M Data 22-04-2020	Lampada Codice L-IT1-0F6-3000-525-2M-70-25 Numero 1 Posizione
-------------------------------------------------------------------------------------------------------------	------------------------------------------------------------------------------------------	-------------------------------------------------------------------------------

Flusso Apparecchio	9250.00 lm	Potenza Apparecchio	76.00 W	Efficacia	121.71 lm/W	Rendimento	100.00%
Flusso Lampade	9250.00 lm	Valore Massimo	781.25 cd/klm	Posizione	C=65.00 G=56.00	CG	Asimmetrico

		Tabella Intensità Luminose - cd/klm											Tabella 5/18	
		C 260.00	C 265.00	C 270.00	C 275.00	C 280.00	C 285.00	C 290.00	C 295.00	C 300.00	C 305.00	C 310.00	C 315.00	C 320.00
G 0.0	365.68	365.68	365.68	365.68	365.68	365.68	365.68	365.68	365.68	365.68	365.68	365.68	365.68	365.68
G 1.0	363.47	363.20	363.06	363.55	363.33	363.84	364.72	365.25	365.45	366.47	365.76	365.76	366.02	366.46
G 2.0	361.36	360.88	360.59	361.58	361.15	362.10	363.77	364.75	365.23	367.16	365.88	366.45	366.52	367.34
G 3.0	359.47	358.84	358.40	359.94	359.29	360.53	362.81	364.10	365.00	367.62	366.09	367.03	367.44	368.44
G 4.0	357.89	357.25	356.66	358.80	357.91	359.23	361.85	363.25	364.77	367.74	366.44	367.85	369.85	
G 5.0	356.74	356.25	355.50	358.30	357.19	358.27	360.88	362.12	364.55	367.41	366.96	368.98	371.68	
G 6.0	356.00	355.84	354.92	356.82	357.13	357.68	359.89	360.68	362.79	366.60	367.68	370.46	373.98	
G 7.0	355.17	355.41	354.34	355.34	357.17	357.16	358.80	359.04	360.71	365.52	368.55	372.13	376.52	
G 8.0	353.64	354.20	353.03	353.86	356.59	356.31	357.49	357.38	358.73	364.51	369.48	373.80	379.03	
G 9.0	350.79	351.47	350.25	352.38	354.67	354.78	355.86	355.85	357.28	363.84	370.41	375.24	381.20	
G 10.0	346.01	346.45	345.27	350.90	350.70	352.18	353.82	354.60	356.77	363.85	371.26	376.28	382.77	
G 11.0	338.60	338.39	337.34	342.90	343.94	347.96	351.00	353.48	352.43	360.56	371.84	376.68	383.50	
G 12.0	327.65	326.50	325.66	330.96	333.57	340.89	346.04	351.02	348.10	357.27	371.50	376.18	383.41	
G 13.0	312.14	309.97	309.41	314.42	318.72	329.59	337.31	345.41	343.76	353.98	369.48	374.48	382.56	
G 14.0	291.09	288.01	287.77	292.64	298.56	312.66	323.19	334.87	339.42	350.69	365.03	371.31	381.01	
G 15.0	263.48	259.83	259.92	264.94	272.24	288.69	302.06	317.60	335.08	347.40	357.37	366.38	378.83	
G 16.0	229.05	225.29	225.71	231.27	239.52	257.05	273.05	292.49	314.66	331.17	345.87	359.37	375.93	
G 17.0	190.38	186.90	187.64	193.93	202.71	220.15	238.28	261.19	287.82	309.34	330.38	349.81	371.59	
G 18.0	150.80	147.87	148.85	155.84	164.73	181.15	200.60	226.05	256.18	282.72	310.84	337.20	364.94	
G 19.0	113.62	111.37	112.52	119.91	128.51	143.21	162.88	189.39	221.38	252.10	287.23	321.05	355.10	
G 20.0	82.16	80.58	81.80	89.04	96.97	109.50	127.98	153.56	185.07	218.31	259.49	300.86	341.20	
G 21.0	58.91	57.89	59.06	65.43	72.35	82.48	98.24	120.60	148.87	182.37	227.94	276.41	322.65	
G 22.0	43.04	42.46	43.49	48.49	54.18	61.87	73.86	91.41	114.45	146.23	194.23	248.56	300.00	
G 23.0	32.92	32.66	33.50	36.90	41.27	46.67	54.49	66.59	83.44	112.08	160.36	218.46	274.10	
G 24.0	26.89	26.83	27.48	29.36	32.48	35.90	39.80	46.74	57.52	82.09	128.35	187.26	245.78	
G 25.0	23.30	23.35	23.85	24.55	26.63	28.57	29.46	32.45	38.34	58.43	100.18	156.11	215.89	
G 26.0	20.75	20.82	21.24	21.33	22.69	23.76	23.02	30.23	35.39	42.62	77.42	126.14	185.32	
G 27.0	18.81	18.85	19.26	19.19	20.10	20.83	19.60	28.02	32.45	33.41	59.78	98.38	155.21	
G 28.0	17.30	17.29	17.74	17.80	18.47	19.21	18.25	25.80	29.51	28.92	46.54	73.87	126.75	
G 29.0	16.04	15.98	16.52	16.81	17.37	18.34	17.98	23.58	26.57	27.25	36.97	53.63	101.12	
G 30.0	14.83	14.78	15.45	15.89	16.39	17.64	17.83	21.36	23.62	26.48	30.35	38.69	79.52	
G 31.0	13.54	13.58	14.39	14.77	15.20	16.66	17.01	19.85	21.71	25.09	25.98	35.92	62.79	
G 32.0	12.17	12.37	13.31	13.46	13.82	15.38	15.60	18.34	19.80	23.01	23.28	33.15	50.42	
G 33.0	10.80	11.20	12.21	12.08	12.37	13.92	13.88	16.84	17.89	20.52	21.68	30.38	41.55	
G 34.0	9.46	10.10	11.08	10.71	10.96	12.39	12.11	15.33	15.97	17.92	20.65	27.61	35.34	
G 35.0	8.23	9.11	9.91	9.46	9.69	10.88	10.57	13.82	14.06	15.51	19.62	24.84	30.92	
G 36.0	7.14	8.24	8.71	8.39	8.66	9.50	9.46	12.06	12.15	13.52	18.16	23.91	27.54	
G 37.0	6.22	7.51	7.54	7.50	7.84	8.27	8.74	10.67	10.84	11.94	16.36	21.85	24.90	
G 38.0	5.49	6.88	6.43	6.79	7.16	7.20	8.27	9.56	9.93	10.68	14.38	19.15	22.78	
G 39.0	4.96	6.34	5.46	6.23	6.57	6.31	7.93	8.68	9.23	9.67	12.44	16.30	20.98	
G 40.0	4.65	5.87	4.68	5.80	6.02	5.60	7.59	7.94	8.55	8.84	10.71	13.79	19.28	
G 41.0	4.55	5.45	4.13	5.49	5.47	5.09	7.17	7.29	7.76	8.12	9.36	11.99	17.54	
G 42.0	4.61	5.08	3.77	5.26	4.93	4.73	6.67	6.69	6.88	7.49	8.33	10.82	15.77	
G 43.0	4.74	4.74	3.56	5.09	4.44	4.50	6.13	6.16	6.02	6.96	7.57	10.06	14.04	
G 44.0	4.87	4.45	3.45	4.95	4.02	4.34	5.60	5.69	5.25	6.51	6.98	9.50	12.43	
G 45.0	4.90	4.19	3.40	4.81	3.71	4.22	5.13	5.27	4.67	6.14	6.49	8.94	11.01	
G 46.0	4.80	3.95	3.39	4.65	3.52	4.11	4.73	4.91	4.33	5.84	6.04	8.22	9.83	
G 47.0	4.56	3.76	3.37	4.46	3.43	4.00	4.40	4.59	4.18	5.59	5.62	7.37	8.87	
G 48.0	4.25	3.60	3.36	4.25	3.40	3.89	4.12	4.31	4.15	5.36	5.23	6.51	8.07	
G 49.0	3.90	3.50	3.35	4.00	3.39	3.79	3.85	4.07	4.14	5.13	4.90	5.71	7.39	
G 50.0	3.54	3.45	3.33	3.72	3.36	3.69	3.58	3.87	4.08	4.86	4.61	5.07	6.79	
G 51.0	3.23	3.47	3.33	3.41	3.29	3.61	3.28	3.71	3.90	4.54	4.39	4.65	6.22	
G 52.0	2.97	3.51	3.33	3.10	3.17	3.54	2.99	3.57	3.64	4.19	4.21	4.43	5.69	
G 53.0	2.77	3.55	3.33	2.82	3.02	3.46	2.72	3.44	3.34	3.82	4.06	4.33	5.21	
G 54.0	2.64	3.55	3.33	2.60	2.87	3.37	2.51	3.32	3.04	3.47	3.94	4.29	4.78	
G 55.0	2.60	3.46	3.33	2.48	2.72	3.27	2.39	3.20	2.79	3.16	3.83	4.24	4.41	
G 56.0	2.65	3.26	3.20	2.47	2.58	3.15	2.38	3.07	2.63	2.91	3.71	4.14	4.11	
G 57.0	2.74	2.99	3.01	2.54	2.47	3.02	2.44	2.93	2.54	2.71	3.59	3.98	3.87	
G 58.0	2.86	2.69	2.80	2.65	2.37	2.88	2.53	2.79	2.49	2.57	3.47	3.77	3.66	
G 59.0	2.94	2.41	2.58	2.73	2.29	2.75	2.61	2.65	2.47	2.47	3.34	3.53	3.47	
G 60.0	2.96	2.18	2.38	2.75	2.21	2.63	2.62	2.50	2.45	2.40	3.21	3.26	3.27	
G 61.0	2.89	2.15	2.21	2.67	2.15	2.54	2.55	2.36	2.42	2.37	3.08	2.97	3.06	
G 62.0	2.75	2.11	2.07	2.51	2.09	2.45	2.40	2.23	2.37	2.34	2.95	2.69	2.84	
G 63.0	2.56	2.07	1.97	2.31	2.03	2.38	2.21	2.12	2.32	2.30	2.81	2.43	2.63	
G 64.0	2.36	2.04	1.88	2.10	1.96	2.30	2.03	2.02	2.27	2.24	2.65	2.21	2.45	
G 65.0	2.19	2.00	1.81	1.93	1.90	2.22	1.87	1.94	2.25	2.13	2.49	2.04	2.32	
G 66.0	2.05	1.96	1.75	1.81	1.82	2.12	1.78	1.89	2.24	1.96	2.31	1.94	2.23	
G 67.0	1.96	1.89	1.69	1.75	1.74	2.01	1.72	1.86	2.24	1.75	2.14	1.89	2.19	
G 68.0	1.88	1.81	1.64	1.70	1.67	1.91	1.70	1.84	2.24	1.55	1.99	1.87	2.17	
G 69.0	1.81	1.74	1.59	1.66	1.61	1.83	1.69	1.83	2.20	1.39	1.88	1.85	2.15	
G 70.0	1.74	1.68	1.54	1.60	1.57	1.77	1.66	1.81	2.11	1.30	1.84	1.80	2.11	
G 71.0	1.64	1.65	1.49	1.49	1.56	1.74	1.60	1.79	1.96	1.31	1.86	1.72	2.04	
G 72.0	1.53	1.64	1.44	1.37	1.55	1.74	1.53	1.76	1.78	1.39	1.94	1.61	1.93	

Apparecchio	Rilievo	Lampada
Codice ITALO 1 0F6 OP-DX 3.5-2M	Codice 18-009_0718	Codice L-IT1-0F6-3000-525-2M-70-25
Nome ITALO 1 0F6 OP-DX 3.5-2M	Nome ITALO 1 0F6 OP-DX 3.5-2M	Numero 1
Archivio Eulumdat	Data 22-04-2020	Posizione

Flusso Apparecchio	9250.00 lm	Potenza Apparecchio	76.00 W	Efficacia	121.71 lm/W	Rendimento	100.00%
Flusso Lampade	9250.00 lm	Valore Massimo	781.25 cd/klm	Posizione	C=65.00 G=56.00	CG	Asimmetrico

	Tabella Intensità Luminose - cd/klm				Tabella 6/18		
	C 325.00	C 330.00	C 335.00	C 340.00	C 345.00	C 350.00	C 355.00
G 0.0	365.68	365.68	365.68	365.68	365.68	365.68	365.68
G 1.0	366.93	368.26	369.32	369.99	370.13	369.94	370.08
G 2.0	368.31	370.89	372.84	374.09	374.40	374.07	374.34
G 3.0	369.97	373.62	376.12	377.74	378.30	377.95	378.34
G 4.0	372.02	376.50	379.04	380.72	381.66	381.46	381.93
G 5.0	374.62	379.56	381.48	382.83	384.29	384.47	384.99
G 6.0	377.80	382.83	383.38	383.94	386.09	386.89	387.45
G 7.0	381.30	386.11	384.91	384.40	387.29	388.85	389.47
G 8.0	384.74	389.18	386.31	384.67	388.21	390.51	391.30
G 9.0	387.78	391.81	387.81	385.20	389.14	392.02	393.17
G 10.0	390.05	393.78	389.66	386.45	390.39	393.55	395.31
G 11.0	391.29	394.92	391.99	388.71	392.21	395.23	397.89
G 12.0	391.58	395.34	394.50	391.68	394.50	397.04	400.72
G 13.0	391.14	395.20	396.80	394.85	397.09	398.95	403.57
G 14.0	390.14	394.66	398.51	397.76	399.82	400.90	406.16
G 15.0	388.79	393.88	399.22	399.93	402.52	402.86	408.26
G 16.0	387.14	392.99	398.70	399.76	405.02	404.80	409.71
G 17.0	384.69	391.93	397.27	399.60	407.21	406.70	410.76
G 18.0	380.82	390.62	395.43	399.44	408.97	408.60	411.75
G 19.0	374.89	388.97	393.66	399.27	410.18	410.50	413.06
G 20.0	366.26	386.88	392.45	399.11	410.72	412.41	415.02
G 21.0	354.48	384.16	392.07	398.57	410.54	414.34	417.86
G 22.0	339.70	380.15	391.97	398.24	409.81	416.28	421.31
G 23.0	322.28	374.07	391.40	398.03	408.78	418.20	424.97
G 24.0	302.53	365.15	389.60	397.83	407.69	420.09	428.45
G 25.0	280.79	352.63	385.81	397.56	406.78	421.91	431.33
G 26.0	257.39	336.00	379.44	397.08	406.65	423.62	433.31
G 27.0	232.68	315.83	370.49	396.13	406.53	424.98	434.42
G 28.0	206.96	292.95	359.14	394.40	406.41	425.74	434.75
G 29.0	180.59	268.20	345.56	391.61	406.28	425.64	434.43
G 30.0	153.88	242.43	329.93	387.45	406.16	424.41	433.55
G 31.0	127.31	216.38	312.40	381.63	404.59	421.92	432.22
G 32.0	101.85	190.48	293.18	373.90	403.03	418.45	430.47
G 33.0	78.64	165.08	272.42	364.00	401.47	414.43	428.32
G 34.0	58.80	140.54	250.31	351.68	399.90	410.27	425.78
G 35.0	43.44	117.19	227.03	336.71	398.34	406.39	422.87
G 36.0	33.30	95.42	202.83	318.97	392.81	403.04	419.59
G 37.0	27.49	75.70	178.26	299.03	385.42	399.95	415.84
G 38.0	24.73	58.54	153.97	277.57	376.12	396.69	411.50
G 39.0	23.75	44.42	130.57	255.29	364.85	392.82	406.45
G 40.0	23.27	33.87	108.71	232.90	351.56	387.92	400.56
G 41.0	22.25	27.14	88.92	210.96	336.25	381.62	393.73
G 42.0	20.68	23.50	71.47	189.49	319.23	373.90	385.90
G 43.0	18.80	22.00	56.51	168.39	300.87	364.79	377.07
G 44.0	16.85	21.68	44.21	147.55	281.54	354.32	367.20
G 45.0	15.05	21.56	34.74	126.86	261.60	342.54	356.25
G 46.0	13.59	20.89	28.12	106.36	241.36	329.51	344.25
G 47.0	12.43	19.64	23.84	86.66	220.85	315.35	331.38
G 48.0	11.48	18.01	21.25	68.50	200.00	300.23	317.86
G 49.0	10.65	16.19	19.68	52.66	178.76	284.30	303.91
G 50.0	9.85	14.35	18.49	39.89	157.09	267.71	289.76
G 51.0	9.00	12.64	17.14	30.68	135.06	250.59	275.58
G 52.0	8.12	11.12	15.61	24.51	113.32	233.01	261.35
G 53.0	7.25	9.79	14.00	20.59	92.63	214.99	247.00
G 54.0	6.42	8.65	12.42	18.14	73.78	196.56	232.46
G 55.0	5.66	7.72	10.97	16.38	57.52	177.75	217.66
G 56.0	5.01	7.00	9.72	14.65	44.45	158.66	202.59
G 57.0	4.47	6.43	8.67	12.90	34.29	139.59	187.41
G 58.0	4.02	5.95	7.79	11.20	26.58	120.90	172.36
G 59.0	3.66	5.51	7.04	9.61	20.89	102.96	157.66
G 60.0	3.38	5.04	6.38	8.22	16.73	86.12	143.55
G 61.0	3.16	4.50	5.80	7.08	13.69	70.70	130.18
G 62.0	3.00	3.93	5.26	6.17	11.52	56.86	117.40
G 63.0	2.86	3.38	4.77	5.44	9.98	44.68	104.96
G 64.0	2.75	2.91	4.30	4.87	8.87	34.28	92.63
G 65.0	2.63	2.58	3.84	4.42	7.94	25.74	80.18
G 66.0	2.50	2.54	3.39	4.04	7.03	19.11	67.51
G 67.0	2.35	2.51	2.96	3.72	6.13	14.15	55.00
G 68.0	2.21	2.48	2.56	3.46	5.26	10.55	43.16
G 69.0	2.07	2.44	2.22	3.23	4.46	8.01	32.51
G 70.0	1.95	2.41	1.94	3.02	3.75	6.23	23.56
G 71.0	1.85	2.26	1.73	2.83	3.16	4.94	16.69
G 72.0	1.77	2.03	1.60	2.64	2.68	4.02	11.68



Apparecchio	Rilievo	Lampada
Codice ITALO 1 0F6 OP-DX 3.5-2M	Codice 18-009_0718	Codice L-IT1-0F6-3000-525-2M-70-25
Nome ITALO 1 0F6 OP-DX 3.5-2M	Nome ITALO 1 0F6 OP-DX 3.5-2M	Numero 1
Archivio Eulumdat	Data 22-04-2020	Posizione

Flusso Apparecchio	9250.00 lm	Potenza Apparecchio	76.00 W	Efficacia	121.71 lm/W	Rendimento	100.00%
Flusso Lampade	9250.00 lm	Valore Massimo	781.25 cd/klm	Posizione	C=65.00 G=56.00	CG	Asimmetrico

Tabella Intensità Luminose - cd/klm Tabella 7/18

	C 0.00	C 5.00	C 10.00	C 15.00	C 20.00	C 25.00	C 30.00	C 35.00	C 40.00	C 45.00	C 50.00	C 55.00	C 60.00
G 73.0	11.31	14.98	23.08	34.53	56.17	83.69	115.83	147.88	175.73	187.91	199.42	211.67	203.21
G 74.0	8.20	11.41	17.73	27.11	44.88	68.72	96.23	120.84	143.49	154.70	160.64	169.39	161.09
G 75.0	6.03	8.80	13.62	21.15	35.18	55.38	78.36	96.44	114.19	124.42	126.42	131.81	124.17
G 76.0	4.59	6.93	10.67	16.61	27.32	44.04	62.46	75.45	88.82	97.47	97.60	100.11	93.54
G 77.0	3.72	5.64	8.65	13.26	21.13	34.60	48.59	57.82	67.38	73.99	73.87	74.09	68.86
G 78.0	3.23	4.76	7.30	10.82	16.31	26.82	36.72	43.27	49.62	54.05	54.67	53.19	49.39
G 79.0	2.97	4.15	6.34	9.00	12.55	20.49	26.84	31.54	35.29	37.69	39.43	36.85	34.38
G 80.0	2.75	3.64	5.50	7.51	9.56	15.37	18.95	22.36	24.15	25.00	27.57	24.51	23.12
G 81.0	2.44	3.12	4.58	6.12	7.09	11.26	12.96	15.44	15.91	15.90	18.54	15.60	14.90
G 82.0	2.05	2.57	3.60	4.81	5.05	8.02	8.63	10.43	10.10	9.82	11.90	9.51	9.16
G 83.0	1.62	2.04	2.63	3.62	3.42	5.52	5.61	6.94	6.23	6.06	7.24	5.63	5.41
G 84.0	1.19	1.53	1.74	2.57	2.17	3.66	3.60	4.60	3.80	3.92	4.12	3.34	3.11
G 85.0	0.82	1.09	1.03	1.72	1.25	2.31	2.27	3.03	2.30	2.70	2.13	2.03	1.75
G 86.0	0.53	0.73	0.53	1.07	1.00	1.36	1.35	1.91	1.31	1.82	1.71	1.16	0.89
G 87.0	0.31	0.46	0.24	0.61	0.75	0.73	0.72	1.13	0.68	1.13	1.29	0.59	0.37
G 88.0	0.17	0.25	0.08	0.31	0.50	0.35	0.33	0.60	0.32	0.62	0.87	0.25	0.11
G 89.0	0.07	0.11	0.02	0.12	0.25	0.15	0.11	0.29	0.14	0.26	0.45	0.08	0.01
G 90.0	0.00	0.00	0.00	0.00	0.00	0.00	0.00	0.00	0.00	0.00	0.00	0.00	0.00
G 91.0	0.00	0.00	0.00	0.00	0.00	0.00	0.00	0.00	0.00	0.00	0.00	0.00	0.00
G 92.0	0.00	0.00	0.00	0.00	0.00	0.00	0.00	0.00	0.00	0.00	0.00	0.00	0.00
G 93.0	0.00	0.00	0.00	0.00	0.00	0.00	0.00	0.00	0.00	0.00	0.00	0.00	0.00
G 94.0	0.00	0.00	0.00	0.00	0.00	0.00	0.00	0.00	0.00	0.00	0.00	0.00	0.00
G 95.0	0.00	0.00	0.00	0.00	0.00	0.00	0.00	0.00	0.00	0.00	0.00	0.00	0.00
G 96.0	0.00	0.00	0.00	0.00	0.00	0.00	0.00	0.00	0.00	0.00	0.00	0.00	0.00
G 97.0	0.00	0.00	0.00	0.00	0.00	0.00	0.00	0.00	0.00	0.00	0.00	0.00	0.00
G 98.0	0.00	0.00	0.00	0.00	0.00	0.00	0.00	0.00	0.00	0.00	0.00	0.00	0.00
G 99.0	0.00	0.00	0.00	0.00	0.00	0.00	0.00	0.00	0.00	0.00	0.00	0.00	0.00
G100.0	0.00	0.00	0.00	0.00	0.00	0.00	0.00	0.00	0.00	0.00	0.00	0.00	0.00
G101.0	0.00	0.00	0.00	0.00	0.00	0.00	0.00	0.00	0.00	0.00	0.00	0.00	0.00
G102.0	0.00	0.00	0.00	0.00	0.00	0.00	0.00	0.00	0.00	0.00	0.00	0.00	0.00
G103.0	0.00	0.00	0.00	0.00	0.00	0.00	0.00	0.00	0.00	0.00	0.00	0.00	0.00
G104.0	0.00	0.00	0.00	0.00	0.00	0.00	0.00	0.00	0.00	0.00	0.00	0.00	0.00
G105.0	0.00	0.00	0.00	0.00	0.00	0.00	0.00	0.00	0.00	0.00	0.00	0.00	0.00
G106.0	0.00	0.00	0.00	0.00	0.00	0.00	0.00	0.00	0.00	0.00	0.00	0.00	0.00
G107.0	0.00	0.00	0.00	0.00	0.00	0.00	0.00	0.00	0.00	0.00	0.00	0.00	0.00
G108.0	0.00	0.00	0.00	0.00	0.00	0.00	0.00	0.00	0.00	0.00	0.00	0.00	0.00
G109.0	0.00	0.00	0.00	0.00	0.00	0.00	0.00	0.00	0.00	0.00	0.00	0.00	0.00
G110.0	0.00	0.00	0.00	0.00	0.00	0.00	0.00	0.00	0.00	0.00	0.00	0.00	0.00
G111.0	0.00	0.00	0.00	0.00	0.00	0.00	0.00	0.00	0.00	0.00	0.00	0.00	0.00
G112.0	0.00	0.00	0.00	0.00	0.00	0.00	0.00	0.00	0.00	0.00	0.00	0.00	0.00
G113.0	0.00	0.00	0.00	0.00	0.00	0.00	0.00	0.00	0.00	0.00	0.00	0.00	0.00
G114.0	0.00	0.00	0.00	0.00	0.00	0.00	0.00	0.00	0.00	0.00	0.00	0.00	0.00
G115.0	0.00	0.00	0.00	0.00	0.00	0.00	0.00	0.00	0.00	0.00	0.00	0.00	0.00
G116.0	0.00	0.00	0.00	0.00	0.00	0.00	0.00	0.00	0.00	0.00	0.00	0.00	0.00
G117.0	0.00	0.00	0.00	0.00	0.00	0.00	0.00	0.00	0.00	0.00	0.00	0.00	0.00
G118.0	0.00	0.00	0.00	0.00	0.00	0.00	0.00	0.00	0.00	0.00	0.00	0.00	0.00
G119.0	0.00	0.00	0.00	0.00	0.00	0.00	0.00	0.00	0.00	0.00	0.00	0.00	0.00
G120.0	0.00	0.00	0.00	0.00	0.00	0.00	0.00	0.00	0.00	0.00	0.00	0.00	0.00
G121.0	0.00	0.00	0.00	0.00	0.00	0.00	0.00	0.00	0.00	0.00	0.00	0.00	0.00
G122.0	0.00	0.00	0.00	0.00	0.00	0.00	0.00	0.00	0.00	0.00	0.00	0.00	0.00
G123.0	0.00	0.00	0.00	0.00	0.00	0.00	0.00	0.00	0.00	0.00	0.00	0.00	0.00
G124.0	0.00	0.00	0.00	0.00	0.00	0.00	0.00	0.00	0.00	0.00	0.00	0.00	0.00
G125.0	0.00	0.00	0.00	0.00	0.00	0.00	0.00	0.00	0.00	0.00	0.00	0.00	0.00
G126.0	0.00	0.00	0.00	0.00	0.00	0.00	0.00	0.00	0.00	0.00	0.00	0.00	0.00
G127.0	0.00	0.00	0.00	0.00	0.00	0.00	0.00	0.00	0.00	0.00	0.00	0.00	0.00
G128.0	0.00	0.00	0.00	0.00	0.00	0.00	0.00	0.00	0.00	0.00	0.00	0.00	0.00
G129.0	0.00	0.00	0.00	0.00	0.00	0.00	0.00	0.00	0.00	0.00	0.00	0.00	0.00
G130.0	0.00	0.00	0.00	0.00	0.00	0.00	0.00	0.00	0.00	0.00	0.00	0.00	0.00
G131.0	0.00	0.00	0.00	0.00	0.00	0.00	0.00	0.00	0.00	0.00	0.00	0.00	0.00
G132.0	0.00	0.00	0.00	0.00	0.00	0.00	0.00	0.00	0.00	0.00	0.00	0.00	0.00
G133.0	0.00	0.00	0.00	0.00	0.00	0.00	0.00	0.00	0.00	0.00	0.00	0.00	0.00
G134.0	0.00	0.00	0.00	0.00	0.00	0.00	0.00	0.00	0.00	0.00	0.00	0.00	0.00
G135.0	0.00	0.00	0.00	0.00	0.00	0.00	0.00	0.00	0.00	0.00	0.00	0.00	0.00
G136.0	0.00	0.00	0.00	0.00	0.00	0.00	0.00	0.00	0.00	0.00	0.00	0.00	0.00
G137.0	0.00	0.00	0.00	0.00	0.00	0.00	0.00	0.00	0.00	0.00	0.00	0.00	0.00
G138.0	0.00	0.00	0.00	0.00	0.00	0.00	0.00	0.00	0.00	0.00	0.00	0.00	0.00
G139.0	0.00	0.00	0.00	0.00	0.00	0.00	0.00	0.00	0.00	0.00	0.00	0.00	0.00
G140.0	0.00	0.00	0.00	0.00	0.00	0.00	0.00	0.00	0.00	0.00	0.00	0.00	0.00
G141.0	0.00	0.00	0.00	0.00	0.00	0.00	0.00	0.00	0.00	0.00	0.00	0.00	0.00
G142.0	0.00	0.00	0.00	0.00	0.00	0.00	0.00	0.00	0.00	0.00	0.00	0.00	0.00
G143.0	0.00	0.00	0.00	0.00	0.00	0.00	0.00	0.00	0.00	0.00	0.00	0.00	0.00
G144.0	0.00	0.00	0.00	0.00	0.00	0.00	0.00	0.00	0.00	0.00	0.00	0.00	0.00
G145.0	0.00	0.00	0.00	0.00	0.00	0.00	0.00	0.00	0.00	0.00	0.00	0.00	0.00

Apparecchio	Rilievo	Lampada
Codice ITALO 1 0F6 OP-DX 3.5-2M	Codice 18-009_0718	Codice L-IT1-0F6-3000-525-2M-70-25
Nome ITALO 1 0F6 OP-DX 3.5-2M	Nome ITALO 1 0F6 OP-DX 3.5-2M	Numero 1
Archivio Eulumdat	Data 22-04-2020	Posizione

Flusso Apparecchio	9250.00 lm	Potenza Apparecchio	76.00 W	Efficacia	121.71 lm/W	Rendimento	100.00%
Flusso Lampade	9250.00 lm	Valore Massimo	781.25 cd/klm	Posizione	C=65.00 G=56.00	CG	Asimmetrico

Tabella Intensità Luminose - cd/klm Tabella 8/18

	C 65.00	C 70.00	C 75.00	C 80.00	C 85.00	C 90.00	C 95.00	C 100.00	C 105.00	C 110.00	C 115.00	C 120.00	C 125.00
G 73.0	188.54	180.03	160.49	148.14	138.30	133.26	122.09	119.40	112.53	109.57	102.01	96.06	86.53
G 74.0	144.17	135.45	118.39	107.18	99.27	95.00	85.35	84.66	81.30	80.20	76.03	73.76	66.31
G 75.0	106.54	98.22	83.71	73.82	67.63	64.04	55.80	56.51	55.93	55.94	54.49	54.76	49.19
G 76.0	77.06	70.08	58.07	49.76	45.02	42.02	35.24	36.68	37.60	37.93	38.23	39.62	35.61
G 77.0	54.95	49.96	40.34	33.74	30.20	27.70	22.41	24.01	25.37	25.40	26.61	28.00	25.20
G 78.0	38.82	36.06	28.66	23.77	21.20	19.14	15.28	16.66	17.74	17.15	18.64	19.34	17.47
G 79.0	27.32	26.63	21.20	17.87	16.06	14.39	11.81	12.76	13.21	11.96	13.32	13.07	11.87
G 80.0	19.07	19.88	16.11	14.05	12.83	11.50	9.96	10.46	10.31	8.59	9.65	8.64	7.89
G 81.0	12.90	14.33	11.88	10.66	9.90	8.87	8.09	8.25	7.78	6.04	6.80	5.52	5.06
G 82.0	8.33	9.67	8.22	7.50	7.07	6.32	6.02	5.96	5.47	4.03	4.55	3.44	3.13
G 83.0	5.11	5.91	5.17	4.70	4.50	3.98	3.97	3.79	3.44	2.51	2.82	2.15	1.89
G 84.0	2.93	3.04	2.78	2.40	2.35	2.02	2.14	1.91	1.80	1.41	1.57	1.41	1.16
G 85.0	1.53	1.05	1.09	0.73	0.77	0.58	0.74	0.52	0.61	0.67	0.72	0.99	0.73
G 86.0	1.23	0.84	0.87	0.59	0.61	0.46	0.59	0.41	0.51	0.53	0.59	0.67	0.44
G 87.0	0.92	0.63	0.65	0.44	0.46	0.35	0.44	0.31	0.41	0.40	0.45	0.42	0.24
G 88.0	0.61	0.42	0.43	0.29	0.31	0.23	0.30	0.21	0.30	0.27	0.31	0.22	0.11
G 89.0	0.31	0.21	0.22	0.15	0.15	0.12	0.15	0.10	0.20	0.13	0.18	0.09	0.04
G 90.0	0.00	0.00	0.00	0.00	0.00	0.00	0.00	0.00	0.00	0.00	0.00	0.00	0.00
G 91.0	0.00	0.00	0.00	0.00	0.00	0.00	0.00	0.00	0.00	0.00	0.00	0.00	0.00
G 92.0	0.00	0.00	0.00	0.00	0.00	0.00	0.00	0.00	0.00	0.00	0.00	0.00	0.00
G 93.0	0.00	0.00	0.00	0.00	0.00	0.00	0.00	0.00	0.00	0.00	0.00	0.00	0.00
G 94.0	0.00	0.00	0.00	0.00	0.00	0.00	0.00	0.00	0.00	0.00	0.00	0.00	0.00
G 95.0	0.00	0.00	0.00	0.00	0.00	0.00	0.00	0.00	0.00	0.00	0.00	0.00	0.00
G 96.0	0.00	0.00	0.00	0.00	0.00	0.00	0.00	0.00	0.00	0.00	0.00	0.00	0.00
G 97.0	0.00	0.00	0.00	0.00	0.00	0.00	0.00	0.00	0.00	0.00	0.00	0.00	0.00
G 98.0	0.00	0.00	0.00	0.00	0.00	0.00	0.00	0.00	0.00	0.00	0.00	0.00	0.00
G 99.0	0.00	0.00	0.00	0.00	0.00	0.00	0.00	0.00	0.00	0.00	0.00	0.00	0.00
G100.0	0.00	0.00	0.00	0.00	0.00	0.00	0.00	0.00	0.00	0.00	0.00	0.00	0.00
G101.0	0.00	0.00	0.00	0.00	0.00	0.00	0.00	0.00	0.00	0.00	0.00	0.00	0.00
G102.0	0.00	0.00	0.00	0.00	0.00	0.00	0.00	0.00	0.00	0.00	0.00	0.00	0.00
G103.0	0.00	0.00	0.00	0.00	0.00	0.00	0.00	0.00	0.00	0.00	0.00	0.00	0.00
G104.0	0.00	0.00	0.00	0.00	0.00	0.00	0.00	0.00	0.00	0.00	0.00	0.00	0.00
G105.0	0.00	0.00	0.00	0.00	0.00	0.00	0.00	0.00	0.00	0.00	0.00	0.00	0.00
G106.0	0.00	0.00	0.00	0.00	0.00	0.00	0.00	0.00	0.00	0.00	0.00	0.00	0.00
G107.0	0.00	0.00	0.00	0.00	0.00	0.00	0.00	0.00	0.00	0.00	0.00	0.00	0.00
G108.0	0.00	0.00	0.00	0.00	0.00	0.00	0.00	0.00	0.00	0.00	0.00	0.00	0.00
G109.0	0.00	0.00	0.00	0.00	0.00	0.00	0.00	0.00	0.00	0.00	0.00	0.00	0.00
G110.0	0.00	0.00	0.00	0.00	0.00	0.00	0.00	0.00	0.00	0.00	0.00	0.00	0.00
G111.0	0.00	0.00	0.00	0.00	0.00	0.00	0.00	0.00	0.00	0.00	0.00	0.00	0.00
G112.0	0.00	0.00	0.00	0.00	0.00	0.00	0.00	0.00	0.00	0.00	0.00	0.00	0.00
G113.0	0.00	0.00	0.00	0.00	0.00	0.00	0.00	0.00	0.00	0.00	0.00	0.00	0.00
G114.0	0.00	0.00	0.00	0.00	0.00	0.00	0.00	0.00	0.00	0.00	0.00	0.00	0.00
G115.0	0.00	0.00	0.00	0.00	0.00	0.00	0.00	0.00	0.00	0.00	0.00	0.00	0.00
G116.0	0.00	0.00	0.00	0.00	0.00	0.00	0.00	0.00	0.00	0.00	0.00	0.00	0.00
G117.0	0.00	0.00	0.00	0.00	0.00	0.00	0.00	0.00	0.00	0.00	0.00	0.00	0.00
G118.0	0.00	0.00	0.00	0.00	0.00	0.00	0.00	0.00	0.00	0.00	0.00	0.00	0.00
G119.0	0.00	0.00	0.00	0.00	0.00	0.00	0.00	0.00	0.00	0.00	0.00	0.00	0.00
G120.0	0.00	0.00	0.00	0.00	0.00	0.00	0.00	0.00	0.00	0.00	0.00	0.00	0.00
G121.0	0.00	0.00	0.00	0.00	0.00	0.00	0.00	0.00	0.00	0.00	0.00	0.00	0.00
G122.0	0.00	0.00	0.00	0.00	0.00	0.00	0.00	0.00	0.00	0.00	0.00	0.00	0.00
G123.0	0.00	0.00	0.00	0.00	0.00	0.00	0.00	0.00	0.00	0.00	0.00	0.00	0.00
G124.0	0.00	0.00	0.00	0.00	0.00	0.00	0.00	0.00	0.00	0.00	0.00	0.00	0.00
G125.0	0.00	0.00	0.00	0.00	0.00	0.00	0.00	0.00	0.00	0.00	0.00	0.00	0.00
G126.0	0.00	0.00	0.00	0.00	0.00	0.00	0.00	0.00	0.00	0.00	0.00	0.00	0.00
G127.0	0.00	0.00	0.00	0.00	0.00	0.00	0.00	0.00	0.00	0.00	0.00	0.00	0.00
G128.0	0.00	0.00	0.00	0.00	0.00	0.00	0.00	0.00	0.00	0.00	0.00	0.00	0.00
G129.0	0.00	0.00	0.00	0.00	0.00	0.00	0.00	0.00	0.00	0.00	0.00	0.00	0.00
G130.0	0.00	0.00	0.00	0.00	0.00	0.00	0.00	0.00	0.00	0.00	0.00	0.00	0.00
G131.0	0.00	0.00	0.00	0.00	0.00	0.00	0.00	0.00	0.00	0.00	0.00	0.00	0.00
G132.0	0.00	0.00	0.00	0.00	0.00	0.00	0.00	0.00	0.00	0.00	0.00	0.00	0.00
G133.0	0.00	0.00	0.00	0.00	0.00	0.00	0.00	0.00	0.00	0.00	0.00	0.00	0.00
G134.0	0.00	0.00	0.00	0.00	0.00	0.00	0.00	0.00	0.00	0.00	0.00	0.00	0.00
G135.0	0.00	0.00	0.00	0.00	0.00	0.00	0.00	0.00	0.00	0.00	0.00	0.00	0.00
G136.0	0.00	0.00	0.00	0.00	0.00	0.00	0.00	0.00	0.00	0.00	0.00	0.00	0.00
G137.0	0.00	0.00	0.00	0.00	0.00	0.00	0.00	0.00	0.00	0.00	0.00	0.00	0.00
G138.0	0.00	0.00	0.00	0.00	0.00	0.00	0.00	0.00	0.00	0.00	0.00	0.00	0.00
G139.0	0.00	0.00	0.00	0.00	0.00	0.00	0.00	0.00	0.00	0.00	0.00	0.00	0.00
G140.0	0.00	0.00	0.00	0.00	0.00	0.00	0.00	0.00	0.00	0.00	0.00	0.00	0.00
G141.0	0.00	0.00	0.00	0.00	0.00	0.00	0.00	0.00	0.00	0.00	0.00	0.00	0.00
G142.0	0.00	0.00	0.00	0.00	0.00	0.00	0.00	0.00	0.00	0.00	0.00	0.00	0.00
G143.0	0.00	0.00	0.00	0.00	0.00	0.00	0.00	0.00	0.00	0.00	0.00	0.00	0.00
G144.0	0.00	0.00	0.00	0.00	0.00	0.00	0.00	0.00	0.00	0.00	0.00	0.00	0.00
G145.0	0.00	0.00	0.00	0.00	0.00	0.00	0.00	0.00	0.00	0.00	0.00	0.00	0.00

Apparecchio		Rilievo		Lampada	
Codice	ITALO 1 0F6 OP-DX 3.5-2M	Codice	18-009_0718	Codice	L-IT1-0F6-3000-525-2M-70-25
Nome	ITALO 1 0F6 OP-DX 3.5-2M	Nome	ITALO 1 0F6 OP-DX 3.5-2M	Numero	1
Archivio	Eulumdat	Data	22-04-2020	Posizione	

Flusso Apparecchio	9250.00 lm	Potenza Apparecchio	76.00 W	Efficacia	121.71 lm/W	Rendimento	100.00%
Flusso Lampade	9250.00 lm	Valore Massimo	781.25 cd/klm	Posizione	C=65.00 G=56.00	CG	Asimmetrico

Tabella Intensità Luminose - cd/klm Tabella 9/18

	C 130.00	C 135.00	C 140.00	C 145.00	C 150.00	C 155.00	C 160.00	C 165.00	C 170.00	C 175.00	C 180.00	C 185.00	C 190.00
G 73.0	70.44	56.40	46.63	34.38	20.72	15.20	10.04	6.88	5.46	5.16	4.55	3.10	3.37
G 74.0	54.30	43.53	36.58	28.65	17.41	13.34	9.15	6.59	5.39	4.54	4.11	3.03	3.04
G 75.0	40.79	32.89	28.17	23.57	14.65	11.72	8.36	6.32	5.26	4.05	3.74	2.99	2.74
G 76.0	30.04	24.52	21.41	18.90	12.13	10.09	7.46	5.87	4.88	3.65	3.39	2.87	2.51
G 77.0	21.75	18.14	16.11	14.67	9.84	8.45	6.48	5.25	4.28	3.32	3.07	2.65	2.32
G 78.0	15.51	13.38	12.03	10.96	7.79	6.90	5.48	4.53	3.59	3.05	2.76	2.39	2.17
G 79.0	10.92	9.90	8.94	7.86	6.04	5.48	4.52	3.80	2.89	2.81	2.49	2.09	2.04
G 80.0	7.58	7.32	6.60	5.45	4.61	4.29	3.65	3.11	2.30	2.59	2.23	1.80	1.90
G 81.0	5.13	5.33	4.79	3.78	3.52	3.36	2.95	2.54	1.89	2.37	2.01	1.54	1.73
G 82.0	3.38	3.81	3.42	2.71	2.72	2.67	2.37	2.07	1.64	2.15	1.81	1.31	1.55
G 83.0	2.19	2.68	2.40	2.08	2.15	2.15	1.91	1.69	1.47	1.92	1.61	1.11	1.35
G 84.0	1.42	1.86	1.66	1.73	1.72	1.74	1.53	1.37	1.35	1.66	1.40	0.92	1.14
G 85.0	0.92	1.27	1.12	1.46	1.37	1.39	1.21	1.10	1.20	1.39	1.17	0.74	0.92
G 86.0	0.57	0.84	0.72	1.17	1.04	1.04	0.92	0.85	0.99	1.10	0.91	0.58	0.69
G 87.0	0.34	0.53	0.42	0.83	0.73	0.71	0.65	0.62	0.72	0.79	0.64	0.43	0.47
G 88.0	0.19	0.33	0.21	0.51	0.46	0.42	0.43	0.43	0.45	0.51	0.38	0.29	0.28
G 89.0	0.11	0.20	0.08	0.22	0.23	0.17	0.25	0.27	0.21	0.27	0.16	0.18	0.12
G 90.0	0.00	0.00	0.00	0.00	0.00	0.00	0.00	0.00	0.00	0.00	0.00	0.00	0.00
G 91.0	0.00	0.00	0.00	0.00	0.00	0.00	0.00	0.00	0.00	0.00	0.00	0.00	0.00
G 92.0	0.00	0.00	0.00	0.00	0.00	0.00	0.00	0.00	0.00	0.00	0.00	0.00	0.00
G 93.0	0.00	0.00	0.00	0.00	0.00	0.00	0.00	0.00	0.00	0.00	0.00	0.00	0.00
G 94.0	0.00	0.00	0.00	0.00	0.00	0.00	0.00	0.00	0.00	0.00	0.00	0.00	0.00
G 95.0	0.00	0.00	0.00	0.00	0.00	0.00	0.00	0.00	0.00	0.00	0.00	0.00	0.00
G 96.0	0.00	0.00	0.00	0.00	0.00	0.00	0.00	0.00	0.00	0.00	0.00	0.00	0.00
G 97.0	0.00	0.00	0.00	0.00	0.00	0.00	0.00	0.00	0.00	0.00	0.00	0.00	0.00
G 98.0	0.00	0.00	0.00	0.00	0.00	0.00	0.00	0.00	0.00	0.00	0.00	0.00	0.00
G 99.0	0.00	0.00	0.00	0.00	0.00	0.00	0.00	0.00	0.00	0.00	0.00	0.00	0.00
G100.0	0.00	0.00	0.00	0.00	0.00	0.00	0.00	0.00	0.00	0.00	0.00	0.00	0.00
G101.0	0.00	0.00	0.00	0.00	0.00	0.00	0.00	0.00	0.00	0.00	0.00	0.00	0.00
G102.0	0.00	0.00	0.00	0.00	0.00	0.00	0.00	0.00	0.00	0.00	0.00	0.00	0.00
G103.0	0.00	0.00	0.00	0.00	0.00	0.00	0.00	0.00	0.00	0.00	0.00	0.00	0.00
G104.0	0.00	0.00	0.00	0.00	0.00	0.00	0.00	0.00	0.00	0.00	0.00	0.00	0.00
G105.0	0.00	0.00	0.00	0.00	0.00	0.00	0.00	0.00	0.00	0.00	0.00	0.00	0.00
G106.0	0.00	0.00	0.00	0.00	0.00	0.00	0.00	0.00	0.00	0.00	0.00	0.00	0.00
G107.0	0.00	0.00	0.00	0.00	0.00	0.00	0.00	0.00	0.00	0.00	0.00	0.00	0.00
G108.0	0.00	0.00	0.00	0.00	0.00	0.00	0.00	0.00	0.00	0.00	0.00	0.00	0.00
G109.0	0.00	0.00	0.00	0.00	0.00	0.00	0.00	0.00	0.00	0.00	0.00	0.00	0.00
G110.0	0.00	0.00	0.00	0.00	0.00	0.00	0.00	0.00	0.00	0.00	0.00	0.00	0.00
G111.0	0.00	0.00	0.00	0.00	0.00	0.00	0.00	0.00	0.00	0.00	0.00	0.00	0.00
G112.0	0.00	0.00	0.00	0.00	0.00	0.00	0.00	0.00	0.00	0.00	0.00	0.00	0.00
G113.0	0.00	0.00	0.00	0.00	0.00	0.00	0.00	0.00	0.00	0.00	0.00	0.00	0.00
G114.0	0.00	0.00	0.00	0.00	0.00	0.00	0.00	0.00	0.00	0.00	0.00	0.00	0.00
G115.0	0.00	0.00	0.00	0.00	0.00	0.00	0.00	0.00	0.00	0.00	0.00	0.00	0.00
G116.0	0.00	0.00	0.00	0.00	0.00	0.00	0.00	0.00	0.00	0.00	0.00	0.00	0.00
G117.0	0.00	0.00	0.00	0.00	0.00	0.00	0.00	0.00	0.00	0.00	0.00	0.00	0.00
G118.0	0.00	0.00	0.00	0.00	0.00	0.00	0.00	0.00	0.00	0.00	0.00	0.00	0.00
G119.0	0.00	0.00	0.00	0.00	0.00	0.00	0.00	0.00	0.00	0.00	0.00	0.00	0.00
G120.0	0.00	0.00	0.00	0.00	0.00	0.00	0.00	0.00	0.00	0.00	0.00	0.00	0.00
G121.0	0.00	0.00	0.00	0.00	0.00	0.00	0.00	0.00	0.00	0.00	0.00	0.00	0.00
G122.0	0.00	0.00	0.00	0.00	0.00	0.00	0.00	0.00	0.00	0.00	0.00	0.00	0.00
G123.0	0.00	0.00	0.00	0.00	0.00	0.00	0.00	0.00	0.00	0.00	0.00	0.00	0.00
G124.0	0.00	0.00	0.00	0.00	0.00	0.00	0.00	0.00	0.00	0.00	0.00	0.00	0.00
G125.0	0.00	0.00	0.00	0.00	0.00	0.00	0.00	0.00	0.00	0.00	0.00	0.00	0.00
G126.0	0.00	0.00	0.00	0.00	0.00	0.00	0.00	0.00	0.00	0.00	0.00	0.00	0.00
G127.0	0.00	0.00	0.00	0.00	0.00	0.00	0.00	0.00	0.00	0.00	0.00	0.00	0.00
G128.0	0.00	0.00	0.00	0.00	0.00	0.00	0.00	0.00	0.00	0.00	0.00	0.00	0.00
G129.0	0.00	0.00	0.00	0.00	0.00	0.00	0.00	0.00	0.00	0.00	0.00	0.00	0.00
G130.0	0.00	0.00	0.00	0.00	0.00	0.00	0.00	0.00	0.00	0.00	0.00	0.00	0.00
G131.0	0.00	0.00	0.00	0.00	0.00	0.00	0.00	0.00	0.00	0.00	0.00	0.00	0.00
G132.0	0.00	0.00	0.00	0.00	0.00	0.00	0.00	0.00	0.00	0.00	0.00	0.00	0.00
G133.0	0.00	0.00	0.00	0.00	0.00	0.00	0.00	0.00	0.00	0.00	0.00	0.00	0.00
G134.0	0.00	0.00	0.00	0.00	0.00	0.00	0.00	0.00	0.00	0.00	0.00	0.00	0.00
G135.0	0.00	0.00	0.00	0.00	0.00	0.00	0.00	0.00	0.00	0.00	0.00	0.00	0.00
G136.0	0.00	0.00	0.00	0.00	0.00	0.00	0.00	0.00	0.00	0.00	0.00	0.00	0.00
G137.0	0.00	0.00	0.00	0.00	0.00	0.00	0.00	0.00	0.00	0.00	0.00	0.00	0.00
G138.0	0.00	0.00	0.00	0.00	0.00	0.00	0.00	0.00	0.00	0.00	0.00	0.00	0.00
G139.0	0.00	0.00	0.00	0.00	0.00	0.00	0.00	0.00	0.00	0.00	0.00	0.00	0.00
G140.0	0.00	0.00	0.00	0.00	0.00	0.00	0.00	0.00	0.00	0.00	0.00	0.00	0.00
G141.0	0.00	0.00	0.00	0.00	0.00	0.00	0.00	0.00	0.00	0.00	0.00	0.00	0.00
G142.0	0.00	0.00	0.00	0.00	0.00	0.00	0.00	0.00	0.00	0.00	0.00	0.00	0.00
G143.0	0.00	0.00	0.00	0.00	0.00	0.00	0.00	0.00	0.00	0.00	0.00	0.00	0.00
G144.0	0.00	0.00	0.00	0.00	0.00	0.00	0.00	0.00	0.00	0.00	0.00	0.00	0.00
G145.0	0.00	0.00	0.00	0.00	0.00	0.00	0.00	0.00	0.00	0.00	0.00	0.00	0.00



Apparecchio	Rilievo	Lampada
Codice ITALO 1 0F6 OP-DX 3.5-2M	Codice 18-009_0718	Codice L-IT1-0F6-3000-525-2M-70-25
Nome ITALO 1 0F6 OP-DX 3.5-2M	Nome ITALO 1 0F6 OP-DX 3.5-2M	Numero 1
Archivio Eulumdat	Data 22-04-2020	Posizione

Flusso Apparecchio	9250.00 lm	Potenza Apparecchio	76.00 W	Efficacia	121.71 lm/W	Rendimento	100.00%
Flusso Lampade	9250.00 lm	Valore Massimo	781.25 cd/klm	Posizione	C=65.00 G=56.00	CG	Asimmetrico

Tabella Intensità Luminose - cd/klm Tabella 10/18

	C 195.00	C 200.00	C 205.00	C 210.00	C 215.00	C 220.00	C 225.00	C 230.00	C 235.00	C 240.00	C 245.00	C 250.00	C 255.00
G 73.0	2.70	3.06	2.68	2.52	3.13	2.80	2.23	2.37	1.93	2.20	1.90	1.56	1.61
G 74.0	2.32	3.05	2.66	2.57	3.24	2.55	2.24	2.32	1.98	2.16	1.76	1.31	1.49
G 75.0	2.04	3.04	2.60	2.57	3.26	2.34	2.21	2.23	2.01	2.05	1.64	1.13	1.39
G 76.0	1.90	2.82	2.47	2.50	3.14	2.19	2.14	2.10	1.99	1.86	1.54	1.13	1.31
G 77.0	1.86	2.51	2.28	2.37	2.91	2.09	2.01	1.94	1.94	1.61	1.45	1.12	1.24
G 78.0	1.87	2.16	2.05	2.19	2.62	2.01	1.84	1.75	1.84	1.34	1.37	1.12	1.19
G 79.0	1.88	1.80	1.81	1.97	2.29	1.94	1.64	1.56	1.70	1.08	1.28	1.12	1.13
G 80.0	1.84	1.51	1.56	1.75	1.98	1.83	1.43	1.36	1.53	0.88	1.18	1.11	1.07
G 81.0	1.72	1.31	1.35	1.52	1.72	1.69	1.22	1.19	1.31	0.76	1.06	1.06	1.00
G 82.0	1.53	1.19	1.15	1.29	1.50	1.50	1.00	1.02	1.08	0.70	0.92	0.96	0.92
G 83.0	1.29	1.10	0.97	1.08	1.30	1.29	0.80	0.87	0.85	0.68	0.78	0.83	0.83
G 84.0	1.03	1.03	0.80	0.87	1.11	1.07	0.61	0.72	0.63	0.65	0.63	0.67	0.72
G 85.0	0.78	0.93	0.64	0.67	0.91	0.84	0.45	0.58	0.44	0.61	0.49	0.52	0.60
G 86.0	0.57	0.78	0.49	0.49	0.70	0.62	0.31	0.44	0.29	0.51	0.36	0.38	0.47
G 87.0	0.38	0.60	0.34	0.33	0.49	0.42	0.20	0.31	0.18	0.39	0.25	0.25	0.33
G 88.0	0.24	0.40	0.21	0.19	0.29	0.24	0.12	0.20	0.11	0.25	0.15	0.15	0.20
G 89.0	0.12	0.22	0.10	0.08	0.12	0.10	0.06	0.10	0.06	0.12	0.07	0.07	0.10
G 90.0	0.00	0.00	0.00	0.00	0.00	0.00	0.00	0.00	0.00	0.00	0.00	0.00	0.00
G 91.0	0.00	0.00	0.00	0.00	0.00	0.00	0.00	0.00	0.00	0.00	0.00	0.00	0.00
G 92.0	0.00	0.00	0.00	0.00	0.00	0.00	0.00	0.00	0.00	0.00	0.00	0.00	0.00
G 93.0	0.00	0.00	0.00	0.00	0.00	0.00	0.00	0.00	0.00	0.00	0.00	0.00	0.00
G 94.0	0.00	0.00	0.00	0.00	0.00	0.00	0.00	0.00	0.00	0.00	0.00	0.00	0.00
G 95.0	0.00	0.00	0.00	0.00	0.00	0.00	0.00	0.00	0.00	0.00	0.00	0.00	0.00
G 96.0	0.00	0.00	0.00	0.00	0.00	0.00	0.00	0.00	0.00	0.00	0.00	0.00	0.00
G 97.0	0.00	0.00	0.00	0.00	0.00	0.00	0.00	0.00	0.00	0.00	0.00	0.00	0.00
G 98.0	0.00	0.00	0.00	0.00	0.00	0.00	0.00	0.00	0.00	0.00	0.00	0.00	0.00
G 99.0	0.00	0.00	0.00	0.00	0.00	0.00	0.00	0.00	0.00	0.00	0.00	0.00	0.00
G100.0	0.00	0.00	0.00	0.00	0.00	0.00	0.00	0.00	0.00	0.00	0.00	0.00	0.00
G101.0	0.00	0.00	0.00	0.00	0.00	0.00	0.00	0.00	0.00	0.00	0.00	0.00	0.00
G102.0	0.00	0.00	0.00	0.00	0.00	0.00	0.00	0.00	0.00	0.00	0.00	0.00	0.00
G103.0	0.00	0.00	0.00	0.00	0.00	0.00	0.00	0.00	0.00	0.00	0.00	0.00	0.00
G104.0	0.00	0.00	0.00	0.00	0.00	0.00	0.00	0.00	0.00	0.00	0.00	0.00	0.00
G105.0	0.00	0.00	0.00	0.00	0.00	0.00	0.00	0.00	0.00	0.00	0.00	0.00	0.00
G106.0	0.00	0.00	0.00	0.00	0.00	0.00	0.00	0.00	0.00	0.00	0.00	0.00	0.00
G107.0	0.00	0.00	0.00	0.00	0.00	0.00	0.00	0.00	0.00	0.00	0.00	0.00	0.00
G108.0	0.00	0.00	0.00	0.00	0.00	0.00	0.00	0.00	0.00	0.00	0.00	0.00	0.00
G109.0	0.00	0.00	0.00	0.00	0.00	0.00	0.00	0.00	0.00	0.00	0.00	0.00	0.00
G110.0	0.00	0.00	0.00	0.00	0.00	0.00	0.00	0.00	0.00	0.00	0.00	0.00	0.00
G111.0	0.00	0.00	0.00	0.00	0.00	0.00	0.00	0.00	0.00	0.00	0.00	0.00	0.00
G112.0	0.00	0.00	0.00	0.00	0.00	0.00	0.00	0.00	0.00	0.00	0.00	0.00	0.00
G113.0	0.00	0.00	0.00	0.00	0.00	0.00	0.00	0.00	0.00	0.00	0.00	0.00	0.00
G114.0	0.00	0.00	0.00	0.00	0.00	0.00	0.00	0.00	0.00	0.00	0.00	0.00	0.00
G115.0	0.00	0.00	0.00	0.00	0.00	0.00	0.00	0.00	0.00	0.00	0.00	0.00	0.00
G116.0	0.00	0.00	0.00	0.00	0.00	0.00	0.00	0.00	0.00	0.00	0.00	0.00	0.00
G117.0	0.00	0.00	0.00	0.00	0.00	0.00	0.00	0.00	0.00	0.00	0.00	0.00	0.00
G118.0	0.00	0.00	0.00	0.00	0.00	0.00	0.00	0.00	0.00	0.00	0.00	0.00	0.00
G119.0	0.00	0.00	0.00	0.00	0.00	0.00	0.00	0.00	0.00	0.00	0.00	0.00	0.00
G120.0	0.00	0.00	0.00	0.00	0.00	0.00	0.00	0.00	0.00	0.00	0.00	0.00	0.00
G121.0	0.00	0.00	0.00	0.00	0.00	0.00	0.00	0.00	0.00	0.00	0.00	0.00	0.00
G122.0	0.00	0.00	0.00	0.00	0.00	0.00	0.00	0.00	0.00	0.00	0.00	0.00	0.00
G123.0	0.00	0.00	0.00	0.00	0.00	0.00	0.00	0.00	0.00	0.00	0.00	0.00	0.00
G124.0	0.00	0.00	0.00	0.00	0.00	0.00	0.00	0.00	0.00	0.00	0.00	0.00	0.00
G125.0	0.00	0.00	0.00	0.00	0.00	0.00	0.00	0.00	0.00	0.00	0.00	0.00	0.00
G126.0	0.00	0.00	0.00	0.00	0.00	0.00	0.00	0.00	0.00	0.00	0.00	0.00	0.00
G127.0	0.00	0.00	0.00	0.00	0.00	0.00	0.00	0.00	0.00	0.00	0.00	0.00	0.00
G128.0	0.00	0.00	0.00	0.00	0.00	0.00	0.00	0.00	0.00	0.00	0.00	0.00	0.00
G129.0	0.00	0.00	0.00	0.00	0.00	0.00	0.00	0.00	0.00	0.00	0.00	0.00	0.00
G130.0	0.00	0.00	0.00	0.00	0.00	0.00	0.00	0.00	0.00	0.00	0.00	0.00	0.00
G131.0	0.00	0.00	0.00	0.00	0.00	0.00	0.00	0.00	0.00	0.00	0.00	0.00	0.00
G132.0	0.00	0.00	0.00	0.00	0.00	0.00	0.00	0.00	0.00	0.00	0.00	0.00	0.00
G133.0	0.00	0.00	0.00	0.00	0.00	0.00	0.00	0.00	0.00	0.00	0.00	0.00	0.00
G134.0	0.00	0.00	0.00	0.00	0.00	0.00	0.00	0.00	0.00	0.00	0.00	0.00	0.00
G135.0	0.00	0.00	0.00	0.00	0.00	0.00	0.00	0.00	0.00	0.00	0.00	0.00	0.00
G136.0	0.00	0.00	0.00	0.00	0.00	0.00	0.00	0.00	0.00	0.00	0.00	0.00	0.00
G137.0	0.00	0.00	0.00	0.00	0.00	0.00	0.00	0.00	0.00	0.00	0.00	0.00	0.00
G138.0	0.00	0.00	0.00	0.00	0.00	0.00	0.00	0.00	0.00	0.00	0.00	0.00	0.00
G139.0	0.00	0.00	0.00	0.00	0.00	0.00	0.00	0.00	0.00	0.00	0.00	0.00	0.00
G140.0	0.00	0.00	0.00	0.00	0.00	0.00	0.00	0.00	0.00	0.00	0.00	0.00	0.00
G141.0	0.00	0.00	0.00	0.00	0.00	0.00	0.00	0.00	0.00	0.00	0.00	0.00	0.00
G142.0	0.00	0.00	0.00	0.00	0.00	0.00	0.00	0.00	0.00	0.00	0.00	0.00	0.00
G143.0	0.00	0.00	0.00	0.00	0.00	0.00	0.00	0.00	0.00	0.00	0.00	0.00	0.00
G144.0	0.00	0.00	0.00	0.00	0.00	0.00	0.00	0.00	0.00	0.00	0.00	0.00	0.00
G145.0	0.00	0.00	0.00	0.00	0.00	0.00	0.00	0.00	0.00	0.00	0.00	0.00	0.00

Apparecchio	Rilievo	Lampada
Codice ITALO 1 0F6 OP-DX 3.5-2M	Codice 18-009_0718	Codice L-IT1-0F6-3000-525-2M-70-25
Nome ITALO 1 0F6 OP-DX 3.5-2M	Nome ITALO 1 0F6 OP-DX 3.5-2M	Numero 1
Archivio Eulumdat	Data 22-04-2020	Posizione

Flusso Apparecchio	9250.00 lm	Potenza Apparecchio	76.00 W	Efficacia	121.71 lm/W	Rendimento	100.00%
Flusso Lampade	9250.00 lm	Valore Massimo	781.25 cd/klm	Posizione	C=65.00 G=56.00	CG	Asimmetrico

	Tabella Intensità Luminose - cd/klm						Tabella 11/18						
	C 260.00	C 265.00	C 270.00	C 275.00	C 280.00	C 285.00	C 290.00	C 295.00	C 300.00	C 305.00	C 310.00	C 315.00	C 320.00
G 73.0	1.42	1.62	1.38	1.24	1.54	1.74	1.44	1.72	1.57	1.50	2.01	1.48	1.80
G 74.0	1.32	1.59	1.31	1.14	1.52	1.72	1.34	1.66	1.38	1.59	2.05	1.37	1.65
G 75.0	1.24	1.53	1.23	1.09	1.51	1.68	1.25	1.60	1.22	1.63	2.02	1.28	1.49
G 76.0	1.20	1.41	1.13	1.10	1.41	1.59	1.17	1.53	1.11	1.58	1.88	1.23	1.34
G 77.0	1.17	1.26	1.03	1.15	1.27	1.45	1.09	1.44	1.05	1.46	1.67	1.21	1.19
G 78.0	1.15	1.09	0.93	1.21	1.11	1.30	1.02	1.35	1.01	1.31	1.40	1.20	1.05
G 79.0	1.12	0.92	0.83	1.24	0.95	1.12	0.95	1.25	0.97	1.15	1.13	1.18	0.92
G 80.0	1.09	0.77	0.74	1.22	0.79	0.95	0.87	1.14	0.90	1.00	0.89	1.13	0.81
G 81.0	1.02	0.64	0.66	1.11	0.66	0.78	0.78	1.03	0.80	0.90	0.70	1.04	0.71
G 82.0	0.93	0.54	0.59	0.95	0.55	0.62	0.68	0.91	0.68	0.83	0.56	0.93	0.63
G 83.0	0.83	0.46	0.53	0.75	0.46	0.47	0.58	0.79	0.54	0.77	0.46	0.79	0.55
G 84.0	0.70	0.38	0.47	0.55	0.39	0.34	0.47	0.67	0.40	0.70	0.38	0.64	0.48
G 85.0	0.57	0.31	0.39	0.38	0.32	0.24	0.37	0.55	0.28	0.62	0.31	0.50	0.40
G 86.0	0.43	0.24	0.31	0.24	0.25	0.15	0.27	0.43	0.18	0.50	0.24	0.37	0.31
G 87.0	0.30	0.17	0.22	0.15	0.19	0.09	0.18	0.31	0.11	0.36	0.16	0.26	0.22
G 88.0	0.18	0.10	0.13	0.10	0.14	0.05	0.10	0.21	0.05	0.22	0.10	0.17	0.13
G 89.0	0.07	0.04	0.06	0.06	0.09	0.02	0.04	0.13	0.02	0.09	0.04	0.10	0.05
G 90.0	0.00	0.00	0.00	0.00	0.00	0.00	0.00	0.00	0.00	0.00	0.00	0.00	0.00
G 91.0	0.00	0.00	0.00	0.00	0.00	0.00	0.00	0.00	0.00	0.00	0.00	0.00	0.00
G 92.0	0.00	0.00	0.00	0.00	0.00	0.00	0.00	0.00	0.00	0.00	0.00	0.00	0.00
G 93.0	0.00	0.00	0.00	0.00	0.00	0.00	0.00	0.00	0.00	0.00	0.00	0.00	0.00
G 94.0	0.00	0.00	0.00	0.00	0.00	0.00	0.00	0.00	0.00	0.00	0.00	0.00	0.00
G 95.0	0.00	0.00	0.00	0.00	0.00	0.00	0.00	0.00	0.00	0.00	0.00	0.00	0.00
G 96.0	0.00	0.00	0.00	0.00	0.00	0.00	0.00	0.00	0.00	0.00	0.00	0.00	0.00
G 97.0	0.00	0.00	0.00	0.00	0.00	0.00	0.00	0.00	0.00	0.00	0.00	0.00	0.00
G 98.0	0.00	0.00	0.00	0.00	0.00	0.00	0.00	0.00	0.00	0.00	0.00	0.00	0.00
G 99.0	0.00	0.00	0.00	0.00	0.00	0.00	0.00	0.00	0.00	0.00	0.00	0.00	0.00
G100.0	0.00	0.00	0.00	0.00	0.00	0.00	0.00	0.00	0.00	0.00	0.00	0.00	0.00
G101.0	0.00	0.00	0.00	0.00	0.00	0.00	0.00	0.00	0.00	0.00	0.00	0.00	0.00
G102.0	0.00	0.00	0.00	0.00	0.00	0.00	0.00	0.00	0.00	0.00	0.00	0.00	0.00
G103.0	0.00	0.00	0.00	0.00	0.00	0.00	0.00	0.00	0.00	0.00	0.00	0.00	0.00
G104.0	0.00	0.00	0.00	0.00	0.00	0.00	0.00	0.00	0.00	0.00	0.00	0.00	0.00
G105.0	0.00	0.00	0.00	0.00	0.00	0.00	0.00	0.00	0.00	0.00	0.00	0.00	0.00
G106.0	0.00	0.00	0.00	0.00	0.00	0.00	0.00	0.00	0.00	0.00	0.00	0.00	0.00
G107.0	0.00	0.00	0.00	0.00	0.00	0.00	0.00	0.00	0.00	0.00	0.00	0.00	0.00
G108.0	0.00	0.00	0.00	0.00	0.00	0.00	0.00	0.00	0.00	0.00	0.00	0.00	0.00
G109.0	0.00	0.00	0.00	0.00	0.00	0.00	0.00	0.00	0.00	0.00	0.00	0.00	0.00
G110.0	0.00	0.00	0.00	0.00	0.00	0.00	0.00	0.00	0.00	0.00	0.00	0.00	0.00
G111.0	0.00	0.00	0.00	0.00	0.00	0.00	0.00	0.00	0.00	0.00	0.00	0.00	0.00
G112.0	0.00	0.00	0.00	0.00	0.00	0.00	0.00	0.00	0.00	0.00	0.00	0.00	0.00
G113.0	0.00	0.00	0.00	0.00	0.00	0.00	0.00	0.00	0.00	0.00	0.00	0.00	0.00
G114.0	0.00	0.00	0.00	0.00	0.00	0.00	0.00	0.00	0.00	0.00	0.00	0.00	0.00
G115.0	0.00	0.00	0.00	0.00	0.00	0.00	0.00	0.00	0.00	0.00	0.00	0.00	0.00
G116.0	0.00	0.00	0.00	0.00	0.00	0.00	0.00	0.00	0.00	0.00	0.00	0.00	0.00
G117.0	0.00	0.00	0.00	0.00	0.00	0.00	0.00	0.00	0.00	0.00	0.00	0.00	0.00
G118.0	0.00	0.00	0.00	0.00	0.00	0.00	0.00	0.00	0.00	0.00	0.00	0.00	0.00
G119.0	0.00	0.00	0.00	0.00	0.00	0.00	0.00	0.00	0.00	0.00	0.00	0.00	0.00
G120.0	0.00	0.00	0.00	0.00	0.00	0.00	0.00	0.00	0.00	0.00	0.00	0.00	0.00
G121.0	0.00	0.00	0.00	0.00	0.00	0.00	0.00	0.00	0.00	0.00	0.00	0.00	0.00
G122.0	0.00	0.00	0.00	0.00	0.00	0.00	0.00	0.00	0.00	0.00	0.00	0.00	0.00
G123.0	0.00	0.00	0.00	0.00	0.00	0.00	0.00	0.00	0.00	0.00	0.00	0.00	0.00
G124.0	0.00	0.00	0.00	0.00	0.00	0.00	0.00	0.00	0.00	0.00	0.00	0.00	0.00
G125.0	0.00	0.00	0.00	0.00	0.00	0.00	0.00	0.00	0.00	0.00	0.00	0.00	0.00
G126.0	0.00	0.00	0.00	0.00	0.00	0.00	0.00	0.00	0.00	0.00	0.00	0.00	0.00
G127.0	0.00	0.00	0.00	0.00	0.00	0.00	0.00	0.00	0.00	0.00	0.00	0.00	0.00
G128.0	0.00	0.00	0.00	0.00	0.00	0.00	0.00	0.00	0.00	0.00	0.00	0.00	0.00
G129.0	0.00	0.00	0.00	0.00	0.00	0.00	0.00	0.00	0.00	0.00	0.00	0.00	0.00
G130.0	0.00	0.00	0.00	0.00	0.00	0.00	0.00	0.00	0.00	0.00	0.00	0.00	0.00
G131.0	0.00	0.00	0.00	0.00	0.00	0.00	0.00	0.00	0.00	0.00	0.00	0.00	0.00
G132.0	0.00	0.00	0.00	0.00	0.00	0.00	0.00	0.00	0.00	0.00	0.00	0.00	0.00
G133.0	0.00	0.00	0.00	0.00	0.00	0.00	0.00	0.00	0.00	0.00	0.00	0.00	0.00
G134.0	0.00	0.00	0.00	0.00	0.00	0.00	0.00	0.00	0.00	0.00	0.00	0.00	0.00
G135.0	0.00	0.00	0.00	0.00	0.00	0.00	0.00	0.00	0.00	0.00	0.00	0.00	0.00
G136.0	0.00	0.00	0.00	0.00	0.00	0.00	0.00	0.00	0.00	0.00	0.00	0.00	0.00
G137.0	0.00	0.00	0.00	0.00	0.00	0.00	0.00	0.00	0.00	0.00	0.00	0.00	0.00
G138.0	0.00	0.00	0.00	0.00	0.00	0.00	0.00	0.00	0.00	0.00	0.00	0.00	0.00
G139.0	0.00	0.00	0.00	0.00	0.00	0.00	0.00	0.00	0.00	0.00	0.00	0.00	0.00
G140.0	0.00	0.00	0.00	0.00	0.00	0.00	0.00	0.00	0.00	0.00	0.00	0.00	0.00
G141.0	0.00	0.00	0.00	0.00	0.00	0.00	0.00	0.00	0.00	0.00	0.00	0.00	0.00
G142.0	0.00	0.00	0.00	0.00	0.00	0.00	0.00	0.00	0.00	0.00	0.00	0.00	0.00
G143.0	0.00	0.00	0.00	0.00	0.00	0.00	0.00	0.00	0.00	0.00	0.00	0.00	0.00
G144.0	0.00	0.00	0.00	0.00	0.00	0.00	0.00	0.00	0.00	0.00	0.00	0.00	0.00
G145.0	0.00	0.00	0.00	0.00	0.00	0.00	0.00	0.00	0.00	0.00	0.00	0.00	0.00

Apparecchio		Rilievo		Lampada	
Codice	ITALO 1 0F6 OP-DX 3.5-2M	Codice	18-009_0718	Codice	L-IT1-0F6-3000-525-2M-70-25
Nome	ITALO 1 0F6 OP-DX 3.5-2M	Nome	ITALO 1 0F6 OP-DX 3.5-2M	Numero	1
Archivio	Eulumdat	Data	22-04-2020	Posizione	

Flusso Apparecchio	9250.00 lm	Potenza Apparecchio	76.00 W	Efficacia	121.71 lm/W	Rendimento	100.00%
Flusso Lampade	9250.00 lm	Valore Massimo	781.25 cd/klm	Posizione	C=65.00 G=56.00	CG	Asimmetrico

Tabella Intensità Luminose - cd/klm Tabella 12/18

	C 325.00	C 330.00	C 335.00	C 340.00	C 345.00	C 350.00	C 355.00
G 73.0	1.70	1.75	1.50	2.46	2.30	3.37	8.19
G 74.0	1.62	1.48	1.44	2.28	2.00	2.92	5.88
G 75.0	1.51	1.26	1.38	2.09	1.77	2.58	4.38
G 76.0	1.39	1.13	1.32	1.90	1.59	2.28	3.40
G 77.0	1.24	1.06	1.25	1.71	1.45	1.99	2.78
G 78.0	1.08	1.04	1.18	1.52	1.33	1.73	2.40
G 79.0	0.92	1.03	1.09	1.33	1.21	1.47	2.16
G 80.0	0.78	1.01	0.99	1.14	1.08	1.23	1.95
G 81.0	0.66	0.95	0.89	0.96	0.93	0.99	1.66
G 82.0	0.56	0.86	0.78	0.78	0.76	0.77	1.33
G 83.0	0.47	0.75	0.66	0.62	0.59	0.56	0.98
G 84.0	0.40	0.62	0.54	0.47	0.43	0.39	0.65
G 85.0	0.32	0.50	0.43	0.35	0.29	0.24	0.39
G 86.0	0.24	0.38	0.32	0.24	0.19	0.14	0.32
G 87.0	0.17	0.26	0.21	0.15	0.11	0.07	0.26
G 88.0	0.10	0.16	0.12	0.08	0.05	0.03	0.19
G 89.0	0.04	0.08	0.05	0.03	0.02	0.01	0.13
G 90.0	0.00	0.00	0.00	0.00	0.00	0.00	0.00
G 91.0	0.00	0.00	0.00	0.00	0.00	0.00	0.00
G 92.0	0.00	0.00	0.00	0.00	0.00	0.00	0.00
G 93.0	0.00	0.00	0.00	0.00	0.00	0.00	0.00
G 94.0	0.00	0.00	0.00	0.00	0.00	0.00	0.00
G 95.0	0.00	0.00	0.00	0.00	0.00	0.00	0.00
G 96.0	0.00	0.00	0.00	0.00	0.00	0.00	0.00
G 97.0	0.00	0.00	0.00	0.00	0.00	0.00	0.00
G 98.0	0.00	0.00	0.00	0.00	0.00	0.00	0.00
G 99.0	0.00	0.00	0.00	0.00	0.00	0.00	0.00
G100.0	0.00	0.00	0.00	0.00	0.00	0.00	0.00
G101.0	0.00	0.00	0.00	0.00	0.00	0.00	0.00
G102.0	0.00	0.00	0.00	0.00	0.00	0.00	0.00
G103.0	0.00	0.00	0.00	0.00	0.00	0.00	0.00
G104.0	0.00	0.00	0.00	0.00	0.00	0.00	0.00
G105.0	0.00	0.00	0.00	0.00	0.00	0.00	0.00
G106.0	0.00	0.00	0.00	0.00	0.00	0.00	0.00
G107.0	0.00	0.00	0.00	0.00	0.00	0.00	0.00
G108.0	0.00	0.00	0.00	0.00	0.00	0.00	0.00
G109.0	0.00	0.00	0.00	0.00	0.00	0.00	0.00
G110.0	0.00	0.00	0.00	0.00	0.00	0.00	0.00
G111.0	0.00	0.00	0.00	0.00	0.00	0.00	0.00
G112.0	0.00	0.00	0.00	0.00	0.00	0.00	0.00
G113.0	0.00	0.00	0.00	0.00	0.00	0.00	0.00
G114.0	0.00	0.00	0.00	0.00	0.00	0.00	0.00
G115.0	0.00	0.00	0.00	0.00	0.00	0.00	0.00
G116.0	0.00	0.00	0.00	0.00	0.00	0.00	0.00
G117.0	0.00	0.00	0.00	0.00	0.00	0.00	0.00
G118.0	0.00	0.00	0.00	0.00	0.00	0.00	0.00
G119.0	0.00	0.00	0.00	0.00	0.00	0.00	0.00
G120.0	0.00	0.00	0.00	0.00	0.00	0.00	0.00
G121.0	0.00	0.00	0.00	0.00	0.00	0.00	0.00
G122.0	0.00	0.00	0.00	0.00	0.00	0.00	0.00
G123.0	0.00	0.00	0.00	0.00	0.00	0.00	0.00
G124.0	0.00	0.00	0.00	0.00	0.00	0.00	0.00
G125.0	0.00	0.00	0.00	0.00	0.00	0.00	0.00
G126.0	0.00	0.00	0.00	0.00	0.00	0.00	0.00
G127.0	0.00	0.00	0.00	0.00	0.00	0.00	0.00
G128.0	0.00	0.00	0.00	0.00	0.00	0.00	0.00
G129.0	0.00	0.00	0.00	0.00	0.00	0.00	0.00
G130.0	0.00	0.00	0.00	0.00	0.00	0.00	0.00
G131.0	0.00	0.00	0.00	0.00	0.00	0.00	0.00
G132.0	0.00	0.00	0.00	0.00	0.00	0.00	0.00
G133.0	0.00	0.00	0.00	0.00	0.00	0.00	0.00
G134.0	0.00	0.00	0.00	0.00	0.00	0.00	0.00
G135.0	0.00	0.00	0.00	0.00	0.00	0.00	0.00
G136.0	0.00	0.00	0.00	0.00	0.00	0.00	0.00
G137.0	0.00	0.00	0.00	0.00	0.00	0.00	0.00
G138.0	0.00	0.00	0.00	0.00	0.00	0.00	0.00
G139.0	0.00	0.00	0.00	0.00	0.00	0.00	0.00
G140.0	0.00	0.00	0.00	0.00	0.00	0.00	0.00
G141.0	0.00	0.00	0.00	0.00	0.00	0.00	0.00
G142.0	0.00	0.00	0.00	0.00	0.00	0.00	0.00
G143.0	0.00	0.00	0.00	0.00	0.00	0.00	0.00
G144.0	0.00	0.00	0.00	0.00	0.00	0.00	0.00
G145.0	0.00	0.00	0.00	0.00	0.00	0.00	0.00

Apparecchio		Rilievo		Lampada	
Codice	ITALO 1 0F6 OP-DX 3.5-2M	Codice	18-009_0718	Codice	L-IT1-0F6-3000-525-2M-70-25
Nome	ITALO 1 0F6 OP-DX 3.5-2M	Nome	ITALO 1 0F6 OP-DX 3.5-2M	Numero	1
Archivio	Eulumdat	Data	22-04-2020	Posizione	

Flusso Apparecchio	9250.00 lm	Potenza Apparecchio	76.00 W	Efficacia	121.71 lm/W	Rendimento	100.00%
Flusso Lampade	9250.00 lm	Valore Massimo	781.25 cd/klm	Posizione	C=65.00 G=56.00	CG	Asimmetrico

Tabella Intensità Luminose - cd/klm Tabella 13/18

	C 0.00	C 5.00	C 10.00	C 15.00	C 20.00	C 25.00	C 30.00	C 35.00	C 40.00	C 45.00	C 50.00	C 55.00	C 60.00
G146.0	0.00	0.00	0.00	0.00	0.00	0.00	0.00	0.00	0.00	0.00	0.00	0.00	0.00
G147.0	0.00	0.00	0.00	0.00	0.00	0.00	0.00	0.00	0.00	0.00	0.00	0.00	0.00
G148.0	0.00	0.00	0.00	0.00	0.00	0.00	0.00	0.00	0.00	0.00	0.00	0.00	0.00
G149.0	0.00	0.00	0.00	0.00	0.00	0.00	0.00	0.00	0.00	0.00	0.00	0.00	0.00
G150.0	0.00	0.00	0.00	0.00	0.00	0.00	0.00	0.00	0.00	0.00	0.00	0.00	0.00
G151.0	0.00	0.00	0.00	0.00	0.00	0.00	0.00	0.00	0.00	0.00	0.00	0.00	0.00
G152.0	0.00	0.00	0.00	0.00	0.00	0.00	0.00	0.00	0.00	0.00	0.00	0.00	0.00
G153.0	0.00	0.00	0.00	0.00	0.00	0.00	0.00	0.00	0.00	0.00	0.00	0.00	0.00
G154.0	0.00	0.00	0.00	0.00	0.00	0.00	0.00	0.00	0.00	0.00	0.00	0.00	0.00
G155.0	0.00	0.00	0.00	0.00	0.00	0.00	0.00	0.00	0.00	0.00	0.00	0.00	0.00
G156.0	0.00	0.00	0.00	0.00	0.00	0.00	0.00	0.00	0.00	0.00	0.00	0.00	0.00
G157.0	0.00	0.00	0.00	0.00	0.00	0.00	0.00	0.00	0.00	0.00	0.00	0.00	0.00
G158.0	0.00	0.00	0.00	0.00	0.00	0.00	0.00	0.00	0.00	0.00	0.00	0.00	0.00
G159.0	0.00	0.00	0.00	0.00	0.00	0.00	0.00	0.00	0.00	0.00	0.00	0.00	0.00
G160.0	0.00	0.00	0.00	0.00	0.00	0.00	0.00	0.00	0.00	0.00	0.00	0.00	0.00
G161.0	0.00	0.00	0.00	0.00	0.00	0.00	0.00	0.00	0.00	0.00	0.00	0.00	0.00
G162.0	0.00	0.00	0.00	0.00	0.00	0.00	0.00	0.00	0.00	0.00	0.00	0.00	0.00
G163.0	0.00	0.00	0.00	0.00	0.00	0.00	0.00	0.00	0.00	0.00	0.00	0.00	0.00
G164.0	0.00	0.00	0.00	0.00	0.00	0.00	0.00	0.00	0.00	0.00	0.00	0.00	0.00
G165.0	0.00	0.00	0.00	0.00	0.00	0.00	0.00	0.00	0.00	0.00	0.00	0.00	0.00
G166.0	0.00	0.00	0.00	0.00	0.00	0.00	0.00	0.00	0.00	0.00	0.00	0.00	0.00
G167.0	0.00	0.00	0.00	0.00	0.00	0.00	0.00	0.00	0.00	0.00	0.00	0.00	0.00
G168.0	0.00	0.00	0.00	0.00	0.00	0.00	0.00	0.00	0.00	0.00	0.00	0.00	0.00
G169.0	0.00	0.00	0.00	0.00	0.00	0.00	0.00	0.00	0.00	0.00	0.00	0.00	0.00
G170.0	0.00	0.00	0.00	0.00	0.00	0.00	0.00	0.00	0.00	0.00	0.00	0.00	0.00
G171.0	0.00	0.00	0.00	0.00	0.00	0.00	0.00	0.00	0.00	0.00	0.00	0.00	0.00
G172.0	0.00	0.00	0.00	0.00	0.00	0.00	0.00	0.00	0.00	0.00	0.00	0.00	0.00
G173.0	0.00	0.00	0.00	0.00	0.00	0.00	0.00	0.00	0.00	0.00	0.00	0.00	0.00
G174.0	0.00	0.00	0.00	0.00	0.00	0.00	0.00	0.00	0.00	0.00	0.00	0.00	0.00
G175.0	0.00	0.00	0.00	0.00	0.00	0.00	0.00	0.00	0.00	0.00	0.00	0.00	0.00
G176.0	0.00	0.00	0.00	0.00	0.00	0.00	0.00	0.00	0.00	0.00	0.00	0.00	0.00
G177.0	0.00	0.00	0.00	0.00	0.00	0.00	0.00	0.00	0.00	0.00	0.00	0.00	0.00
G178.0	0.00	0.00	0.00	0.00	0.00	0.00	0.00	0.00	0.00	0.00	0.00	0.00	0.00
G179.0	0.00	0.00	0.00	0.00	0.00	0.00	0.00	0.00	0.00	0.00	0.00	0.00	0.00
G180.0	0.00	0.00	0.00	0.00	0.00	0.00	0.00	0.00	0.00	0.00	0.00	0.00	0.00

Apparecchio	Rilievo	Lampada
Codice ITALO 1 0F6 OP-DX 3.5-2M	Codice 18-009_0718	Codice L-IT1-0F6-3000-525-2M-70-25
Nome ITALO 1 0F6 OP-DX 3.5-2M	Nome ITALO 1 0F6 OP-DX 3.5-2M	Numero 1
Archivio Eulumdat	Data 22-04-2020	Posizione

Flusso Apparecchio	9250.00 lm	Potenza Apparecchio	76.00 W	Efficacia	121.71 lm/W	Rendimento	100.00%
Flusso Lampade	9250.00 lm	Valore Massimo	781.25 cd/klm	Posizione	C=65.00 G=56.00	CG	Asimmetrico

Tabella Intensità Luminose - cd/klm Tabella 14/18

	C 65.00	C 70.00	C 75.00	C 80.00	C 85.00	C 90.00	C 95.00	C 100.00	C 105.00	C 110.00	C 115.00	C 120.00	C 125.00
G146.0	0.00	0.00	0.00	0.00	0.00	0.00	0.00	0.00	0.00	0.00	0.00	0.00	0.00
G147.0	0.00	0.00	0.00	0.00	0.00	0.00	0.00	0.00	0.00	0.00	0.00	0.00	0.00
G148.0	0.00	0.00	0.00	0.00	0.00	0.00	0.00	0.00	0.00	0.00	0.00	0.00	0.00
G149.0	0.00	0.00	0.00	0.00	0.00	0.00	0.00	0.00	0.00	0.00	0.00	0.00	0.00
G150.0	0.00	0.00	0.00	0.00	0.00	0.00	0.00	0.00	0.00	0.00	0.00	0.00	0.00
G151.0	0.00	0.00	0.00	0.00	0.00	0.00	0.00	0.00	0.00	0.00	0.00	0.00	0.00
G152.0	0.00	0.00	0.00	0.00	0.00	0.00	0.00	0.00	0.00	0.00	0.00	0.00	0.00
G153.0	0.00	0.00	0.00	0.00	0.00	0.00	0.00	0.00	0.00	0.00	0.00	0.00	0.00
G154.0	0.00	0.00	0.00	0.00	0.00	0.00	0.00	0.00	0.00	0.00	0.00	0.00	0.00
G155.0	0.00	0.00	0.00	0.00	0.00	0.00	0.00	0.00	0.00	0.00	0.00	0.00	0.00
G156.0	0.00	0.00	0.00	0.00	0.00	0.00	0.00	0.00	0.00	0.00	0.00	0.00	0.00
G157.0	0.00	0.00	0.00	0.00	0.00	0.00	0.00	0.00	0.00	0.00	0.00	0.00	0.00
G158.0	0.00	0.00	0.00	0.00	0.00	0.00	0.00	0.00	0.00	0.00	0.00	0.00	0.00
G159.0	0.00	0.00	0.00	0.00	0.00	0.00	0.00	0.00	0.00	0.00	0.00	0.00	0.00
G160.0	0.00	0.00	0.00	0.00	0.00	0.00	0.00	0.00	0.00	0.00	0.00	0.00	0.00
G161.0	0.00	0.00	0.00	0.00	0.00	0.00	0.00	0.00	0.00	0.00	0.00	0.00	0.00
G162.0	0.00	0.00	0.00	0.00	0.00	0.00	0.00	0.00	0.00	0.00	0.00	0.00	0.00
G163.0	0.00	0.00	0.00	0.00	0.00	0.00	0.00	0.00	0.00	0.00	0.00	0.00	0.00
G164.0	0.00	0.00	0.00	0.00	0.00	0.00	0.00	0.00	0.00	0.00	0.00	0.00	0.00
G165.0	0.00	0.00	0.00	0.00	0.00	0.00	0.00	0.00	0.00	0.00	0.00	0.00	0.00
G166.0	0.00	0.00	0.00	0.00	0.00	0.00	0.00	0.00	0.00	0.00	0.00	0.00	0.00
G167.0	0.00	0.00	0.00	0.00	0.00	0.00	0.00	0.00	0.00	0.00	0.00	0.00	0.00
G168.0	0.00	0.00	0.00	0.00	0.00	0.00	0.00	0.00	0.00	0.00	0.00	0.00	0.00
G169.0	0.00	0.00	0.00	0.00	0.00	0.00	0.00	0.00	0.00	0.00	0.00	0.00	0.00
G170.0	0.00	0.00	0.00	0.00	0.00	0.00	0.00	0.00	0.00	0.00	0.00	0.00	0.00
G171.0	0.00	0.00	0.00	0.00	0.00	0.00	0.00	0.00	0.00	0.00	0.00	0.00	0.00
G172.0	0.00	0.00	0.00	0.00	0.00	0.00	0.00	0.00	0.00	0.00	0.00	0.00	0.00
G173.0	0.00	0.00	0.00	0.00	0.00	0.00	0.00	0.00	0.00	0.00	0.00	0.00	0.00
G174.0	0.00	0.00	0.00	0.00	0.00	0.00	0.00	0.00	0.00	0.00	0.00	0.00	0.00
G175.0	0.00	0.00	0.00	0.00	0.00	0.00	0.00	0.00	0.00	0.00	0.00	0.00	0.00
G176.0	0.00	0.00	0.00	0.00	0.00	0.00	0.00	0.00	0.00	0.00	0.00	0.00	0.00
G177.0	0.00	0.00	0.00	0.00	0.00	0.00	0.00	0.00	0.00	0.00	0.00	0.00	0.00
G178.0	0.00	0.00	0.00	0.00	0.00	0.00	0.00	0.00	0.00	0.00	0.00	0.00	0.00
G179.0	0.00	0.00	0.00	0.00	0.00	0.00	0.00	0.00	0.00	0.00	0.00	0.00	0.00
G180.0	0.00	0.00	0.00	0.00	0.00	0.00	0.00	0.00	0.00	0.00	0.00	0.00	0.00

Apparecchio		Rilievo		Lampada	
Codice	ITALO 1 0F6 OP-DX 3.5-2M	Codice	18-009_0718	Codice	L-IT1-0F6-3000-525-2M-70-25
Nome	ITALO 1 0F6 OP-DX 3.5-2M	Nome	ITALO 1 0F6 OP-DX 3.5-2M	Numero	1
Archivio	Eulumdat	Data	22-04-2020	Posizione	

Flusso Apparecchio	9250.00 lm	Potenza Apparecchio	76.00 W	Efficacia	121.71 lm/W	Rendimento	100.00%
Flusso Lampade	9250.00 lm	Valore Massimo	781.25 cd/klm	Posizione	C=65.00 G=56.00	CG	Asimmetrico

Tabella Intensità Luminose - cd/klm Tabella 15/18

	C 130.00	C 135.00	C 140.00	C 145.00	C 150.00	C 155.00	C 160.00	C 165.00	C 170.00	C 175.00	C 180.00	C 185.00	C 190.00
G146.0	0.00	0.00	0.00	0.00	0.00	0.00	0.00	0.00	0.00	0.00	0.00	0.00	0.00
G147.0	0.00	0.00	0.00	0.00	0.00	0.00	0.00	0.00	0.00	0.00	0.00	0.00	0.00
G148.0	0.00	0.00	0.00	0.00	0.00	0.00	0.00	0.00	0.00	0.00	0.00	0.00	0.00
G149.0	0.00	0.00	0.00	0.00	0.00	0.00	0.00	0.00	0.00	0.00	0.00	0.00	0.00
G150.0	0.00	0.00	0.00	0.00	0.00	0.00	0.00	0.00	0.00	0.00	0.00	0.00	0.00
G151.0	0.00	0.00	0.00	0.00	0.00	0.00	0.00	0.00	0.00	0.00	0.00	0.00	0.00
G152.0	0.00	0.00	0.00	0.00	0.00	0.00	0.00	0.00	0.00	0.00	0.00	0.00	0.00
G153.0	0.00	0.00	0.00	0.00	0.00	0.00	0.00	0.00	0.00	0.00	0.00	0.00	0.00
G154.0	0.00	0.00	0.00	0.00	0.00	0.00	0.00	0.00	0.00	0.00	0.00	0.00	0.00
G155.0	0.00	0.00	0.00	0.00	0.00	0.00	0.00	0.00	0.00	0.00	0.00	0.00	0.00
G156.0	0.00	0.00	0.00	0.00	0.00	0.00	0.00	0.00	0.00	0.00	0.00	0.00	0.00
G157.0	0.00	0.00	0.00	0.00	0.00	0.00	0.00	0.00	0.00	0.00	0.00	0.00	0.00
G158.0	0.00	0.00	0.00	0.00	0.00	0.00	0.00	0.00	0.00	0.00	0.00	0.00	0.00
G159.0	0.00	0.00	0.00	0.00	0.00	0.00	0.00	0.00	0.00	0.00	0.00	0.00	0.00
G160.0	0.00	0.00	0.00	0.00	0.00	0.00	0.00	0.00	0.00	0.00	0.00	0.00	0.00
G161.0	0.00	0.00	0.00	0.00	0.00	0.00	0.00	0.00	0.00	0.00	0.00	0.00	0.00
G162.0	0.00	0.00	0.00	0.00	0.00	0.00	0.00	0.00	0.00	0.00	0.00	0.00	0.00
G163.0	0.00	0.00	0.00	0.00	0.00	0.00	0.00	0.00	0.00	0.00	0.00	0.00	0.00
G164.0	0.00	0.00	0.00	0.00	0.00	0.00	0.00	0.00	0.00	0.00	0.00	0.00	0.00
G165.0	0.00	0.00	0.00	0.00	0.00	0.00	0.00	0.00	0.00	0.00	0.00	0.00	0.00
G166.0	0.00	0.00	0.00	0.00	0.00	0.00	0.00	0.00	0.00	0.00	0.00	0.00	0.00
G167.0	0.00	0.00	0.00	0.00	0.00	0.00	0.00	0.00	0.00	0.00	0.00	0.00	0.00
G168.0	0.00	0.00	0.00	0.00	0.00	0.00	0.00	0.00	0.00	0.00	0.00	0.00	0.00
G169.0	0.00	0.00	0.00	0.00	0.00	0.00	0.00	0.00	0.00	0.00	0.00	0.00	0.00
G170.0	0.00	0.00	0.00	0.00	0.00	0.00	0.00	0.00	0.00	0.00	0.00	0.00	0.00
G171.0	0.00	0.00	0.00	0.00	0.00	0.00	0.00	0.00	0.00	0.00	0.00	0.00	0.00
G172.0	0.00	0.00	0.00	0.00	0.00	0.00	0.00	0.00	0.00	0.00	0.00	0.00	0.00
G173.0	0.00	0.00	0.00	0.00	0.00	0.00	0.00	0.00	0.00	0.00	0.00	0.00	0.00
G174.0	0.00	0.00	0.00	0.00	0.00	0.00	0.00	0.00	0.00	0.00	0.00	0.00	0.00
G175.0	0.00	0.00	0.00	0.00	0.00	0.00	0.00	0.00	0.00	0.00	0.00	0.00	0.00
G176.0	0.00	0.00	0.00	0.00	0.00	0.00	0.00	0.00	0.00	0.00	0.00	0.00	0.00
G177.0	0.00	0.00	0.00	0.00	0.00	0.00	0.00	0.00	0.00	0.00	0.00	0.00	0.00
G178.0	0.00	0.00	0.00	0.00	0.00	0.00	0.00	0.00	0.00	0.00	0.00	0.00	0.00
G179.0	0.00	0.00	0.00	0.00	0.00	0.00	0.00	0.00	0.00	0.00	0.00	0.00	0.00
G180.0	0.00	0.00	0.00	0.00	0.00	0.00	0.00	0.00	0.00	0.00	0.00	0.00	0.00

Apparecchio	Rilievo	Lampada
Codice ITALO 1 0F6 OP-DX 3.5-2M	Codice 18-009_0718	Codice L-IT1-0F6-3000-525-2M-70-25
Nome ITALO 1 0F6 OP-DX 3.5-2M	Nome ITALO 1 0F6 OP-DX 3.5-2M	Numero 1
Archivio Eulumdat	Data 22-04-2020	Posizione

Flusso Apparecchio	9250.00 lm	Potenza Apparecchio	76.00 W	Efficacia	121.71 lm/W	Rendimento	100.00%
Flusso Lampade	9250.00 lm	Valore Massimo	781.25 cd/klm	Posizione	C=65.00 G=56.00	CG	Asimmetrico

Tabella Intensità Luminose - cd/klm Tabella 16/18

	C 195.00	C 200.00	C 205.00	C 210.00	C 215.00	C 220.00	C 225.00	C 230.00	C 235.00	C 240.00	C 245.00	C 250.00	C 255.00
G146.0	0.00	0.00	0.00	0.00	0.00	0.00	0.00	0.00	0.00	0.00	0.00	0.00	0.00
G147.0	0.00	0.00	0.00	0.00	0.00	0.00	0.00	0.00	0.00	0.00	0.00	0.00	0.00
G148.0	0.00	0.00	0.00	0.00	0.00	0.00	0.00	0.00	0.00	0.00	0.00	0.00	0.00
G149.0	0.00	0.00	0.00	0.00	0.00	0.00	0.00	0.00	0.00	0.00	0.00	0.00	0.00
G150.0	0.00	0.00	0.00	0.00	0.00	0.00	0.00	0.00	0.00	0.00	0.00	0.00	0.00
G151.0	0.00	0.00	0.00	0.00	0.00	0.00	0.00	0.00	0.00	0.00	0.00	0.00	0.00
G152.0	0.00	0.00	0.00	0.00	0.00	0.00	0.00	0.00	0.00	0.00	0.00	0.00	0.00
G153.0	0.00	0.00	0.00	0.00	0.00	0.00	0.00	0.00	0.00	0.00	0.00	0.00	0.00
G154.0	0.00	0.00	0.00	0.00	0.00	0.00	0.00	0.00	0.00	0.00	0.00	0.00	0.00
G155.0	0.00	0.00	0.00	0.00	0.00	0.00	0.00	0.00	0.00	0.00	0.00	0.00	0.00
G156.0	0.00	0.00	0.00	0.00	0.00	0.00	0.00	0.00	0.00	0.00	0.00	0.00	0.00
G157.0	0.00	0.00	0.00	0.00	0.00	0.00	0.00	0.00	0.00	0.00	0.00	0.00	0.00
G158.0	0.00	0.00	0.00	0.00	0.00	0.00	0.00	0.00	0.00	0.00	0.00	0.00	0.00
G159.0	0.00	0.00	0.00	0.00	0.00	0.00	0.00	0.00	0.00	0.00	0.00	0.00	0.00
G160.0	0.00	0.00	0.00	0.00	0.00	0.00	0.00	0.00	0.00	0.00	0.00	0.00	0.00
G161.0	0.00	0.00	0.00	0.00	0.00	0.00	0.00	0.00	0.00	0.00	0.00	0.00	0.00
G162.0	0.00	0.00	0.00	0.00	0.00	0.00	0.00	0.00	0.00	0.00	0.00	0.00	0.00
G163.0	0.00	0.00	0.00	0.00	0.00	0.00	0.00	0.00	0.00	0.00	0.00	0.00	0.00
G164.0	0.00	0.00	0.00	0.00	0.00	0.00	0.00	0.00	0.00	0.00	0.00	0.00	0.00
G165.0	0.00	0.00	0.00	0.00	0.00	0.00	0.00	0.00	0.00	0.00	0.00	0.00	0.00
G166.0	0.00	0.00	0.00	0.00	0.00	0.00	0.00	0.00	0.00	0.00	0.00	0.00	0.00
G167.0	0.00	0.00	0.00	0.00	0.00	0.00	0.00	0.00	0.00	0.00	0.00	0.00	0.00
G168.0	0.00	0.00	0.00	0.00	0.00	0.00	0.00	0.00	0.00	0.00	0.00	0.00	0.00
G169.0	0.00	0.00	0.00	0.00	0.00	0.00	0.00	0.00	0.00	0.00	0.00	0.00	0.00
G170.0	0.00	0.00	0.00	0.00	0.00	0.00	0.00	0.00	0.00	0.00	0.00	0.00	0.00
G171.0	0.00	0.00	0.00	0.00	0.00	0.00	0.00	0.00	0.00	0.00	0.00	0.00	0.00
G172.0	0.00	0.00	0.00	0.00	0.00	0.00	0.00	0.00	0.00	0.00	0.00	0.00	0.00
G173.0	0.00	0.00	0.00	0.00	0.00	0.00	0.00	0.00	0.00	0.00	0.00	0.00	0.00
G174.0	0.00	0.00	0.00	0.00	0.00	0.00	0.00	0.00	0.00	0.00	0.00	0.00	0.00
G175.0	0.00	0.00	0.00	0.00	0.00	0.00	0.00	0.00	0.00	0.00	0.00	0.00	0.00
G176.0	0.00	0.00	0.00	0.00	0.00	0.00	0.00	0.00	0.00	0.00	0.00	0.00	0.00
G177.0	0.00	0.00	0.00	0.00	0.00	0.00	0.00	0.00	0.00	0.00	0.00	0.00	0.00
G178.0	0.00	0.00	0.00	0.00	0.00	0.00	0.00	0.00	0.00	0.00	0.00	0.00	0.00
G179.0	0.00	0.00	0.00	0.00	0.00	0.00	0.00	0.00	0.00	0.00	0.00	0.00	0.00
G180.0	0.00	0.00	0.00	0.00	0.00	0.00	0.00	0.00	0.00	0.00	0.00	0.00	0.00

Apparecchio	Rilievo	Lampada
Codice ITALO 1 0F6 OP-DX 3.5-2M	Codice 18-009_0718	Codice L-IT1-0F6-3000-525-2M-70-25
Nome ITALO 1 0F6 OP-DX 3.5-2M	Nome ITALO 1 0F6 OP-DX 3.5-2M	Numero 1
Archivio Eulumdat	Data 22-04-2020	Posizione

Flusso Apparecchio	9250.00 lm	Potenza Apparecchio	76.00 W	Efficacia	121.71 lm/W	Rendimento	100.00%
Flusso Lampade	9250.00 lm	Valore Massimo	781.25 cd/klm	Posizione	C=65.00 G=56.00	CG	Asimmetrico

Tabella Intensità Luminose - cd/klm Tabella 17/18

	C 260.00	C 265.00	C 270.00	C 275.00	C 280.00	C 285.00	C 290.00	C 295.00	C 300.00	C 305.00	C 310.00	C 315.00	C 320.00
G146.0	0.00	0.00	0.00	0.00	0.00	0.00	0.00	0.00	0.00	0.00	0.00	0.00	0.00
G147.0	0.00	0.00	0.00	0.00	0.00	0.00	0.00	0.00	0.00	0.00	0.00	0.00	0.00
G148.0	0.00	0.00	0.00	0.00	0.00	0.00	0.00	0.00	0.00	0.00	0.00	0.00	0.00
G149.0	0.00	0.00	0.00	0.00	0.00	0.00	0.00	0.00	0.00	0.00	0.00	0.00	0.00
G150.0	0.00	0.00	0.00	0.00	0.00	0.00	0.00	0.00	0.00	0.00	0.00	0.00	0.00
G151.0	0.00	0.00	0.00	0.00	0.00	0.00	0.00	0.00	0.00	0.00	0.00	0.00	0.00
G152.0	0.00	0.00	0.00	0.00	0.00	0.00	0.00	0.00	0.00	0.00	0.00	0.00	0.00
G153.0	0.00	0.00	0.00	0.00	0.00	0.00	0.00	0.00	0.00	0.00	0.00	0.00	0.00
G154.0	0.00	0.00	0.00	0.00	0.00	0.00	0.00	0.00	0.00	0.00	0.00	0.00	0.00
G155.0	0.00	0.00	0.00	0.00	0.00	0.00	0.00	0.00	0.00	0.00	0.00	0.00	0.00
G156.0	0.00	0.00	0.00	0.00	0.00	0.00	0.00	0.00	0.00	0.00	0.00	0.00	0.00
G157.0	0.00	0.00	0.00	0.00	0.00	0.00	0.00	0.00	0.00	0.00	0.00	0.00	0.00
G158.0	0.00	0.00	0.00	0.00	0.00	0.00	0.00	0.00	0.00	0.00	0.00	0.00	0.00
G159.0	0.00	0.00	0.00	0.00	0.00	0.00	0.00	0.00	0.00	0.00	0.00	0.00	0.00
G160.0	0.00	0.00	0.00	0.00	0.00	0.00	0.00	0.00	0.00	0.00	0.00	0.00	0.00
G161.0	0.00	0.00	0.00	0.00	0.00	0.00	0.00	0.00	0.00	0.00	0.00	0.00	0.00
G162.0	0.00	0.00	0.00	0.00	0.00	0.00	0.00	0.00	0.00	0.00	0.00	0.00	0.00
G163.0	0.00	0.00	0.00	0.00	0.00	0.00	0.00	0.00	0.00	0.00	0.00	0.00	0.00
G164.0	0.00	0.00	0.00	0.00	0.00	0.00	0.00	0.00	0.00	0.00	0.00	0.00	0.00
G165.0	0.00	0.00	0.00	0.00	0.00	0.00	0.00	0.00	0.00	0.00	0.00	0.00	0.00
G166.0	0.00	0.00	0.00	0.00	0.00	0.00	0.00	0.00	0.00	0.00	0.00	0.00	0.00
G167.0	0.00	0.00	0.00	0.00	0.00	0.00	0.00	0.00	0.00	0.00	0.00	0.00	0.00
G168.0	0.00	0.00	0.00	0.00	0.00	0.00	0.00	0.00	0.00	0.00	0.00	0.00	0.00
G169.0	0.00	0.00	0.00	0.00	0.00	0.00	0.00	0.00	0.00	0.00	0.00	0.00	0.00
G170.0	0.00	0.00	0.00	0.00	0.00	0.00	0.00	0.00	0.00	0.00	0.00	0.00	0.00
G171.0	0.00	0.00	0.00	0.00	0.00	0.00	0.00	0.00	0.00	0.00	0.00	0.00	0.00
G172.0	0.00	0.00	0.00	0.00	0.00	0.00	0.00	0.00	0.00	0.00	0.00	0.00	0.00
G173.0	0.00	0.00	0.00	0.00	0.00	0.00	0.00	0.00	0.00	0.00	0.00	0.00	0.00
G174.0	0.00	0.00	0.00	0.00	0.00	0.00	0.00	0.00	0.00	0.00	0.00	0.00	0.00
G175.0	0.00	0.00	0.00	0.00	0.00	0.00	0.00	0.00	0.00	0.00	0.00	0.00	0.00
G176.0	0.00	0.00	0.00	0.00	0.00	0.00	0.00	0.00	0.00	0.00	0.00	0.00	0.00
G177.0	0.00	0.00	0.00	0.00	0.00	0.00	0.00	0.00	0.00	0.00	0.00	0.00	0.00
G178.0	0.00	0.00	0.00	0.00	0.00	0.00	0.00	0.00	0.00	0.00	0.00	0.00	0.00
G179.0	0.00	0.00	0.00	0.00	0.00	0.00	0.00	0.00	0.00	0.00	0.00	0.00	0.00
G180.0	0.00	0.00	0.00	0.00	0.00	0.00	0.00	0.00	0.00	0.00	0.00	0.00	0.00

Apparecchio		Rilievo		Lampada	
Codice	ITALO 1 0F6 OP-DX 3.5-2M	Codice	18-009_0718	Codice	L-IT1-0F6-3000-525-2M-70-25
Nome	ITALO 1 0F6 OP-DX 3.5-2M	Nome	ITALO 1 0F6 OP-DX 3.5-2M	Numero	1
Archivio	Eulumdat	Data	22-04-2020	Posizione	

Flusso Apparecchio	9250.00 lm	Potenza Apparecchio	76.00 W	Efficacia	121.71 lm/W	Rendimento	100.00%
Flusso Lampade	9250.00 lm	Valore Massimo	781.25 cd/klm	Posizione	C=65.00 G=56.00	CG	Asimmetrico

Tabella Intensità Luminosa - cd/klm Tabella 18/18

	C 325.00	C 330.00	C 335.00	C 340.00	C 345.00	C 350.00	C 355.00
G146.0	0.00	0.00	0.00	0.00	0.00	0.00	0.00
G147.0	0.00	0.00	0.00	0.00	0.00	0.00	0.00
G148.0	0.00	0.00	0.00	0.00	0.00	0.00	0.00
G149.0	0.00	0.00	0.00	0.00	0.00	0.00	0.00
G150.0	0.00	0.00	0.00	0.00	0.00	0.00	0.00
G151.0	0.00	0.00	0.00	0.00	0.00	0.00	0.00
G152.0	0.00	0.00	0.00	0.00	0.00	0.00	0.00
G153.0	0.00	0.00	0.00	0.00	0.00	0.00	0.00
G154.0	0.00	0.00	0.00	0.00	0.00	0.00	0.00
G155.0	0.00	0.00	0.00	0.00	0.00	0.00	0.00
G156.0	0.00	0.00	0.00	0.00	0.00	0.00	0.00
G157.0	0.00	0.00	0.00	0.00	0.00	0.00	0.00
G158.0	0.00	0.00	0.00	0.00	0.00	0.00	0.00
G159.0	0.00	0.00	0.00	0.00	0.00	0.00	0.00
G160.0	0.00	0.00	0.00	0.00	0.00	0.00	0.00
G161.0	0.00	0.00	0.00	0.00	0.00	0.00	0.00
G162.0	0.00	0.00	0.00	0.00	0.00	0.00	0.00
G163.0	0.00	0.00	0.00	0.00	0.00	0.00	0.00
G164.0	0.00	0.00	0.00	0.00	0.00	0.00	0.00
G165.0	0.00	0.00	0.00	0.00	0.00	0.00	0.00
G166.0	0.00	0.00	0.00	0.00	0.00	0.00	0.00
G167.0	0.00	0.00	0.00	0.00	0.00	0.00	0.00
G168.0	0.00	0.00	0.00	0.00	0.00	0.00	0.00
G169.0	0.00	0.00	0.00	0.00	0.00	0.00	0.00
G170.0	0.00	0.00	0.00	0.00	0.00	0.00	0.00
G171.0	0.00	0.00	0.00	0.00	0.00	0.00	0.00
G172.0	0.00	0.00	0.00	0.00	0.00	0.00	0.00
G173.0	0.00	0.00	0.00	0.00	0.00	0.00	0.00
G174.0	0.00	0.00	0.00	0.00	0.00	0.00	0.00
G175.0	0.00	0.00	0.00	0.00	0.00	0.00	0.00
G176.0	0.00	0.00	0.00	0.00	0.00	0.00	0.00
G177.0	0.00	0.00	0.00	0.00	0.00	0.00	0.00
G178.0	0.00	0.00	0.00	0.00	0.00	0.00	0.00
G179.0	0.00	0.00	0.00	0.00	0.00	0.00	0.00
G180.0	0.00	0.00	0.00	0.00	0.00	0.00	0.00

Apparecchio		Rilievo		Lampada			
Codice	ITALO 1 0F6 OP-DX 3.5-2M	Codice	18-009_0718	Codice	L-IT1-0F6-3000-525-2M-70-25		
Nome	ITALO 1 0F6 OP-DX 3.5-2M	Nome	ITALO 1 0F6 OP-DX 3.5-2M	Numero	1		
Archivio	Eulumdat	Data	22-04-2020	Posizione			
Flusso Apparecchio	9250.00 lm	Potenza Apparecchio	76.00 W	Efficacia	121.71 lm/W	Rendimento	100.00%
Flusso Lampade	9250.00 lm	Valore Massimo	781.25 cd/klm	Posizione	C=65.00 G=56.00	CG	Asimmetrico

Marciapiede			Strada		
Piano	0	0.00%	Piano	0	0.00%
Piano	-5	4.85%	Piano	5	4.98%
Piano	-10	9.54%	Piano	10	10.10%
Piano	-15	13.69%	Piano	15	15.33%
Piano	-20	15.92%	Piano	20	20.63%
Piano	-25	16.48%	Piano	25	26.01%
Piano	-30	16.72%	Piano	30	31.44%
Piano	-35	16.87%	Piano	35	36.99%
Piano	-40	16.97%	Piano	40	42.86%
Piano	-45	17.04%	Piano	45	49.35%
Piano	-50	17.09%	Piano	50	56.62%
Piano	-55	17.14%	Piano	55	64.33%
Piano	-60	17.19%	Piano	60	71.56%
Piano	-65	17.22%	Piano	65	77.24%
Piano	-70	17.25%	Piano	70	80.83%
Piano	-75	17.28%	Piano	75	82.31%
Piano	-80	17.30%	Piano	80	82.62%
Piano	-85	17.31%	Piano	85	82.68%
Piano	-90	17.31%	Piano	90	82.69%

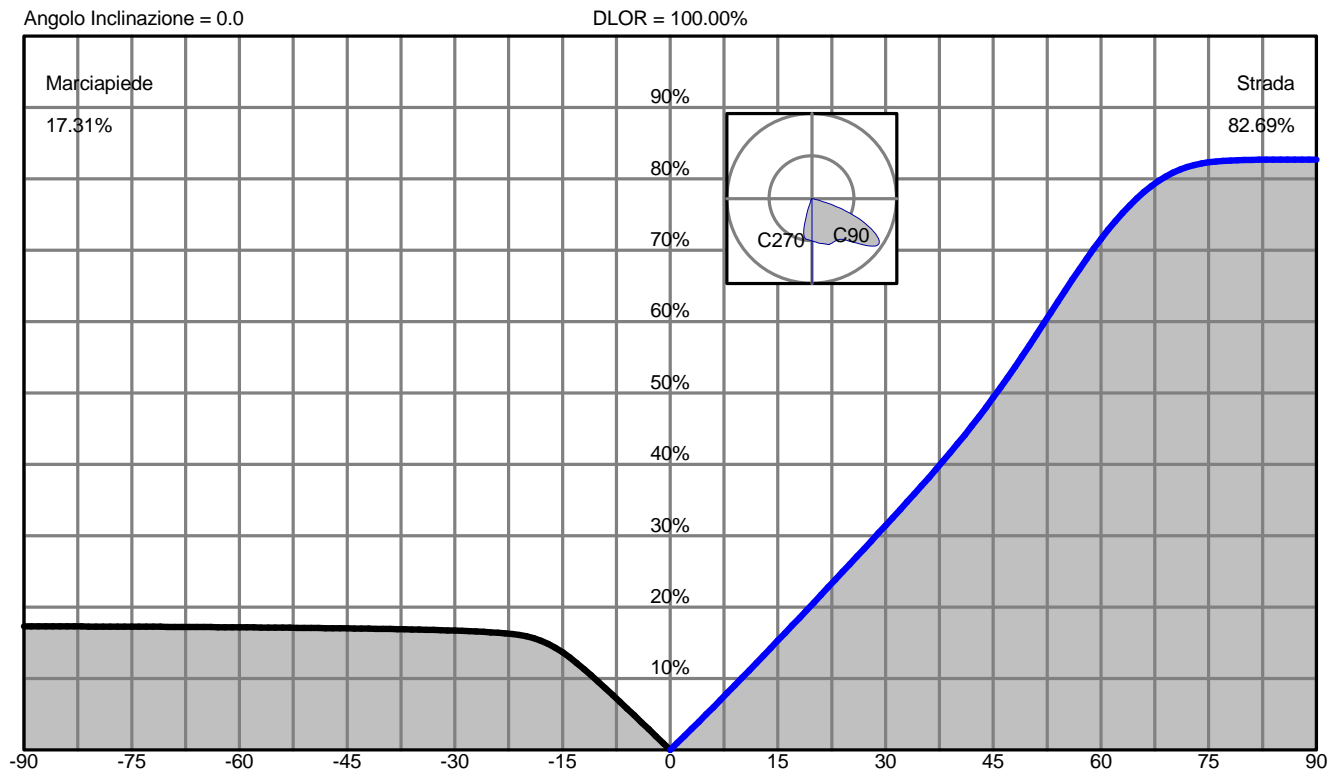

Spread	59.3° Largo	DLOR	100.00000 %
Throw	55.7° Corto	ULOR	0.00000 %
SLI	7.7 Ristretto	Rendimento	100.00000 %
Cutoff CIE	Cutoff - Max: C=65.0° Gamma=56.0°	RN	0.00000 %
Cutoff Iesna	Full Cutoff	Classe Intensità Luminosa	G4
DIN5044	KB1	Indice Abbagliamento	D5
IESNA Type III Very Short Asymmetrical			

Photometric Test Report



Costruttore	AEC ILLUMINAZIONE SRL
Tipo di prodotto	Outdoor Lighting Luminaire
Codice fotometria	ITALO 1 0F6 OP-DX 3.5-1M
Codice apparecchio	ITALO 1 0F6 OP-DX 3.5-1M
Rilievo fotometrico	18-009-8001
Descrizione apparecchio	ITALO 1 0F6 OP-DX 3.5-1M
Data delle prove	23/07/2018

Foto del prodotto



Responsabile laboratorio fotometrico	Luca Vagheggi	
Tecnico laboratorio che ha eseguito la misura	Alessio Vagheggi	





Sommario e Allegati

Sommario	Dati apparecchio	
	Normative di riferimento	
	Procedure di riferimento	
	Condizioni di prova	
	Risultati fotometrici	
	Lista strumentazione	
	Incertezza strumentale	
Allegati	Dati Generali	X
	Tabella fotometrica delle Intensità (cd/Klm)	X
	Tabella fotometrica delle Intensità (cd)	
	Diagramma Polare	
	Diagramma Cartesiano	
	Valutazione UGR	
	Diagramma Sollner Abbagliamento	
	Flusso Zonale	
	Coefficienti di Utilizzazione	
	Isolux Unitario	
	Isocandele Percentuale	
	Tabella e Diagramma Luminanza	
	Classificazione Strade	
Classificazione Strade IES TM-15		





DATI APPARECCHIO

Geometria apparecchio	Rettangolare		
Dimensioni apparecchio (mm)	Lunghezza / Diametro	Larghezza	Altezza
	615	343	106
Dimensioni area luminosa (mm)	Lunghezza / Diametro	Larghezza	Altezza C0
	120	110	0
	Altezza C90	Altezza C180	Altezza C270
	0	0	0
Tipo sorgente	LED		
Modello sorgente	Luxeon-Mx		
Tipo Alimentatore	Elettronico/Electronic		
Modello Alimentatore	Osram OT / Philips Xi		

NORMATIVE DI RIFERIMENTO

Normative di riferimento	EN 13032-1:2012 EN 13032-4:2015 IES LM-79-08
Valutazione luce parassita	In accordo con Annex A UNI EN 13032-1

PROCEDURE DI RIFERIMENTO

Procedure di riferimento	I-QL-009
--------------------------	----------





CONDIZIONI DI PROVA

Laboratorio fotometrico	Interno AEC ILLUMINAZIONE srl, in regime di sistema di qualità aziendale certificato ISO 9001:2008, autorizzato UL	
Condizioni Ambientali	Temperatura ambiente (°C)	25 ± 1
	Umidità relativa (°RH)	< 60
	Movimento aria (m/s)	< 0,2
Condizioni Elettriche	Tensione di alimentazione	230V AC ± 0,2%
	Frequenza di alimentazione	50 Hz ± 0,1%
	Distorsione armonica THD V	< 0,5%
Condizioni Preliminari Prova	Metodo di misura	Goniofotometro Sfera- spettrometro
	Sistema di riferimento misura	Sistema C-γ (Gonio) Integrale (Sfera)
	Posizione di misura	Verticale (Gonio) Orizzontale (Sfera)
	Distanza di misura (m)	9.03
	Tempo di stabilizzazione (min)	120
	Instabilità sorgente	< 0,5%

I risultati delle verifiche e prove qui riportati, si riferiscono esclusivamente agli esemplari esaminati e descritti nella presente Relazione. L'estensione del riferimento ad esemplari che non siano quelli sottoposti alle verifiche descritte in seguito esula dallo scopo delle verifiche stesse. E' vietata la riproduzione integrale o parziale senza l'autorizzazione scritta di Aec illuminazione srl. L'immagine dell'apparecchio nella prima pagina è puramente indicativa della tipologia di apparecchio sottoposto a test.





RISULTATI FOTOMETRICI

Tipo di misura fotometrica	Assoluta
LOR (%)	100.0
Flusso luminoso apparecchio (lm)	4800
Potenza ingresso apparecchio (W)	39.0
Efficienza apparecchio (lm/W)	123
Note e commenti	

LISTA STRUMENTAZIONE

CODICE AEC	STRUMENTO	COSTRUTTORE	MODELLO
Q129	Luxmetro	Czibula&Grundmann	100310
Q130	Goniofotometro	Oxytech	T2
Q131	Termoigrometro	Delta Ohm	HD2001
Q132	Wattmetro	N4L	PPA2510
Q135	Stabilizzatore	Elettrotest	TPS/M/9KW
Q190	Sfera Integratrice	Labsphere	LMS65
Q195	Spettroradiometro	Labsphere	CDS610

INCERTEZZA STRUMENTALE

Encoder goniofotometro Oxytech T2	Precisione angolare in C – gamma	$\pm 0.044^\circ$
Luxmetro C&G	f1'	< 1.23%
Spettroradiometro	Incertezza lunghezza d'onda	< 0.5nm
	Incertezza coordinate cromatiche	± 0.003
Wattmetro Kinetiq N4L PPA2510	Accuratezza di potenza	< [0.05% + 0.03%/pf + (0.01%/kHz)/pf] Rdg + 0.05%VA Rng



Apparecchio		Rilievo		Lampada			
Codice	ITALO 1 0F6 OP-DX 3.5-1M	Codice	18-009-8001	Codice	L-IT1-0F6-3000-525-1M-70-25		
Nome	ITALO 1 0F6 OP-DX 3.5-1M	Nome	ITALO 1 0F6 OP-DX 3.5-1M	Numero	1		
Archivio	Eulumdat	Data	23-07-2018	Posizione			
Flusso Apparecchio	4800.00 lm	Potenza Apparecchio	39.00 W	Efficacia	123.08 lm/W	Rendimento	100.00%
Flusso Lampade	4800.00 lm	Valore Massimo	781.25 cd/klm	Posizione	C=65.00 G=56.00	CG	Asimmetrico
Apparecchio Rettangolare	Lung.	615 mm	Larg.	343 mm	Alt.	106 mm	
Area Luminosa Rettangolare	Lung.	120 mm	Larg.	110 mm	Alt.	0 mm	
Area Luminosa Orizzontale		0.013200 m2	Area Luminosa Piano 180°			0.000000 m2	
Area Luminosa Piano 0°		0.000000 m2	Area Luminosa Piano 270°			0.000000 m2	
Area Luminosa Piano 90°		0.000000 m2	Area Luminosa a 76°			0.003193 m2	
Sistema Coordinate	CG		Tipo di Simmetria			Asimmetrico	
Data	23-07-2018		Massimo Angolo Gamma			180	
Lampade Apparecchio							
Archivio	Codice	Nome		Flusso [lm]	Pot. [W]	Q.tà	
	L-IT1-0F6-3000-525-1M-70-25	L-IT1-0F6-3000-525-1M-70-25 - 39.00 W		4800.00	39.00	1	
C.I.E.	45 81 99 100 100	D DIN 5040		A30			
F UTE	1.00 F	B NBN		BZ 5 / 1 / BZ 4			

615mm x 343mm

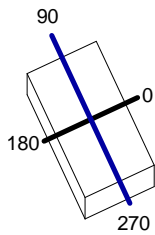

Semipiani C
 180.0 ——— 0.0
 270.0 ——— 90.0

ULOR 0.00 %
 DLOR 100.00 %
 RN 0.00 %

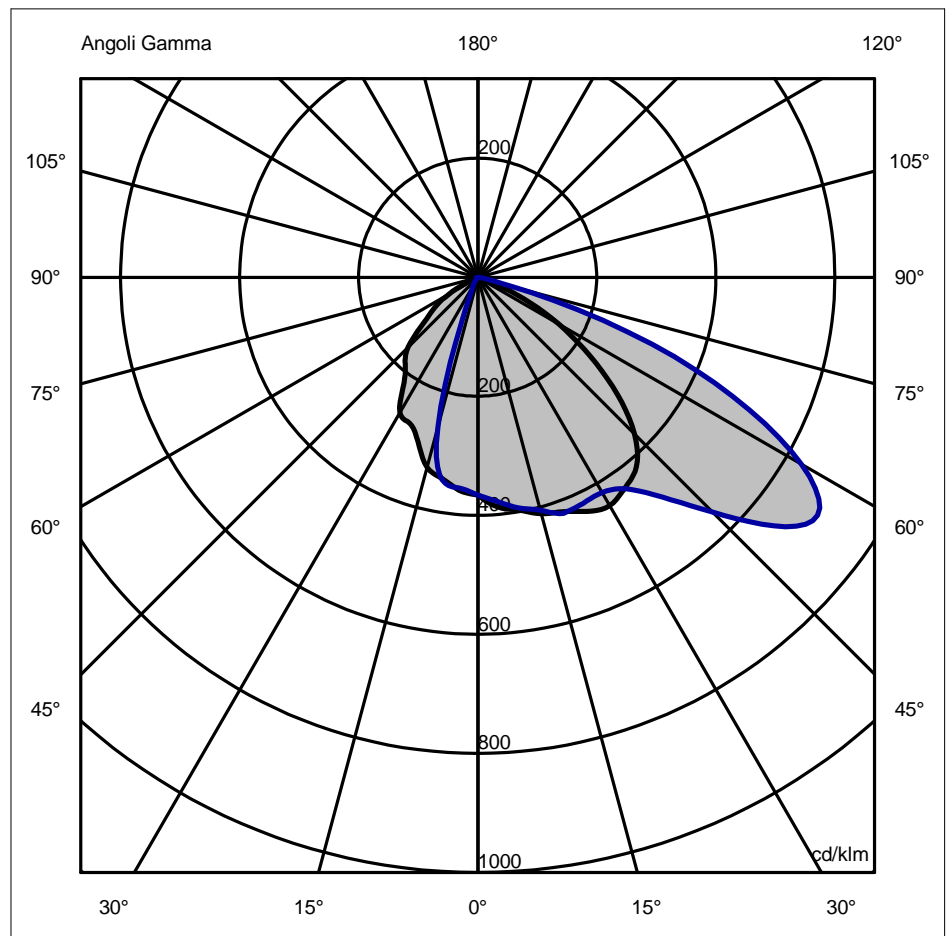



Apparecchio	Rilievo	Lampada
Codice ITALO 1 0F6 OP-DX 3.5-1M	Codice 18-009-8001	Codice L-IT1-0F6-3000-525-1M-70-25
Nome ITALO 1 0F6 OP-DX 3.5-1M	Nome ITALO 1 0F6 OP-DX 3.5-1M	Numero 1
Archivio Eulumdat	Data 23-07-2018	Posizione

Flusso Apparecchio	4800.00 lm	Potenza Apparecchio	39.00 W	Efficacia	123.08 lm/W	Rendimento	100.00%
Flusso Lampade	4800.00 lm	Valore Massimo	781.25 cd/klm	Posizione	C=65.00 G=56.00	CG	Asimmetrico

Tabella Intensità Luminose - cd/klm														Tabella 1/18														
	C 0.00	C 5.00	C 10.00	C 15.00	C 20.00	C 25.00	C 30.00	C 35.00	C 40.00	C 45.00	C 50.00	C 55.00	C 60.00		C 0.00	C 5.00	C 10.00	C 15.00	C 20.00	C 25.00	C 30.00	C 35.00	C 40.00	C 45.00	C 50.00	C 55.00	C 60.00	
G 0.0	365.68	365.68	365.68	365.68	365.68	365.68	365.68	365.68	365.68	365.68	365.68	365.68	365.68	365.68	365.68	365.68	365.68	365.68	365.68	365.68	365.68	365.68	365.68	365.68	365.68	365.68	365.68	365.68
G 1.0	370.69	369.94	369.84	370.14	369.54	369.00	369.64	369.30	367.96	367.66	367.64	368.31	368.34	368.34	367.69	367.94	367.92	368.51	368.11	367.34	367.80	367.81	367.43	367.65	367.71	367.92	367.10	367.11
G 2.0	375.54	374.13	373.92	374.51	373.42	372.39	373.67	372.99	370.47	369.90	369.90	371.03	371.03	371.11	369.72	369.97	369.95	370.59	370.19	373.34	373.80	373.81	373.43	373.65	373.71	373.92	373.10	373.11
G 3.0	380.04	378.18	377.87	378.69	377.34	375.94	377.80	376.81	373.43	372.65	372.65	373.71	373.71	373.71	372.36	372.61	372.59	373.23	372.83	377.34	377.76	377.77	377.39	377.61	377.67	377.88	377.06	377.07
G 4.0	384.01	382.01	381.59	382.59	381.32	379.72	382.11	380.81	377.07	376.16	376.16	377.22	377.22	377.22	375.81	376.06	376.04	376.68	376.28	380.81	381.27	381.28	380.90	381.12	381.18	381.39	380.57	380.58
G 5.0	387.30	385.55	385.03	386.11	385.37	383.81	386.64	385.05	381.62	380.69	380.69	381.75	381.75	381.75	380.34	380.59	380.57	381.21	380.81	385.37	385.83	385.84	385.46	385.68	385.74	385.95	385.13	385.14
G 6.0	389.80	388.77	388.15	389.23	388.50	386.94	389.77	388.18	384.75	383.82	383.82	384.88	384.88	384.88	383.47	383.72	383.70	384.36	383.96	388.50	388.96	388.97	388.59	388.81	388.87	389.08	388.26	388.27
G 7.0	391.74	391.75	391.07	392.15	391.63	389.81	392.81	391.39	387.96	387.03	387.03	388.09	388.09	388.09	386.68	386.93	386.91	387.57	387.17	391.63	392.09	392.10	391.72	391.94	392.00	392.21	391.39	391.40
G 8.0	393.41	394.63	393.97	395.15	394.68	392.82	395.82	394.40	390.97	390.04	390.04	391.10	391.10	391.10	389.69	389.94	389.92	390.60	390.20	394.63	395.09	395.10	394.72	394.94	395.00	395.21	394.39	394.40
G 9.0	395.11	397.55	396.99	398.51	401.54	401.52	404.67	403.48	405.75	405.94	405.94	407.00	407.00	407.00	405.59	405.84	405.82	406.50	406.10	397.55	398.01	398.02	397.64	397.86	397.92	398.13	397.31	397.32
G 10.0	397.14	400.62	400.32	402.50	405.13	405.20	407.87	407.71	410.93	411.59	411.59	412.65	412.65	412.65	411.24	411.49	411.47	412.15	411.75	400.62	401.08	401.09	400.71	400.93	401.00	401.21	400.39	400.40
G 11.0	399.72	403.93	404.05	407.29	408.39	408.20	410.14	411.54	414.94	416.11	416.11	417.17	417.17	417.17	415.76	416.01	415.99	416.67	416.27	403.93	404.39	404.40	404.02	404.24	404.31	404.52	403.70	403.71
G 12.0	402.66	407.35	408.03	412.56	411.41	410.75	411.87	415.12	418.09	419.75	419.75	420.81	420.81	420.81	419.40	419.65	419.63	420.31	420.01	407.35	407.81	407.82	407.44	407.66	407.73	407.94	407.12	407.13
G 13.0	405.70	410.67	412.08	417.92	414.29	413.17	413.58	418.64	420.85	422.91	422.91	423.97	423.97	423.97	422.56	422.81	422.79	423.47	423.17	410.67	411.13	411.14	410.76	410.98	411.05	411.26	410.44	410.45
G 14.0	408.59	413.72	415.98	422.96	417.15	415.76	415.80	422.31	423.66	426.00	426.00	427.06	427.06	427.06	425.65	425.90	425.88	426.56	426.26	413.72	414.18	414.19	413.81	414.03	414.10	414.31	413.49	413.50
G 15.0	411.06	416.31	419.53	427.25	420.11	418.83	419.04	426.34	427.01	429.42	429.42	430.48	430.48	430.48	429.07	429.32	429.30	430.00	429.70	416.31	416.77	416.78	416.40	416.62	416.69	416.90	416.08	416.09
G 16.0	412.93	418.31	422.58	430.51	423.28	422.65	423.69	430.86	431.21	433.49	433.49	434.55	434.55	434.55	433.14	433.39	433.37	434.07	433.77	412.93	413.39	413.40	413.02	413.24	413.31	413.52	412.70	412.71
G 17.0	414.38	419.92	425.17	432.94	426.78	427.21	429.50	435.80	436.08	438.09	438.09	439.15	439.15	439.15	437.74	437.99	437.97	438.67	438.37	419.92	420.38	420.39	420.01	420.23	420.30	420.51	419.69	419.70
G 18.0	415.68	421.38	427.40	434.88	430.72	432.48	436.08	441.03	441.29	443.01	443.01	444.07	444.07	444.07	442.66	442.91	442.89	443.59	443.29	415.68	416.14	416.15	415.77	415.99	416.06	416.27	415.45	415.46
G 19.0	417.10	422.96	429.36	436.64	435.21	438.40	443.04	446.41	446.52	448.04	448.04	449.10	449.10	449.10	447.69	447.94	447.92	448.64	448.34	417.10	417.56	417.57	417.19	417.41	417.48	417.69	416.87	416.88
G 20.0	418.89	424.91	431.14	438.57	440.37	444.91	450.00	451.81	451.43	452.95	452.95	454.01	454.01	454.01	452.60	452.85	452.83	453.55	453.25	418.89	419.35	419.36	418.98	419.20	419.27	419.48	418.66	418.67
G 21.0	421.25	427.42	432.86	440.90	446.21	451.90	456.62	457.12	455.81	457.62	457.62	458.68	458.68	458.68	457.27	457.52	457.50	458.24	457.94	421.25	421.71	421.72	421.34	421.56	421.63	421.84	421.02	421.03
G 22.0	424.08	430.39	434.67	443.61	452.32	458.93	462.76	462.34	459.85	462.07	462.07	463.13	463.13	463.13	461.72	461.97	461.95	462.69	462.39	424.08	424.54	424.55	424.17	424.39	424.46	424.67	423.85	423.86
G 23.0	427.22	433.66	436.73	446.57	458.20	465.47	468.34	467.48	463.83	466.41	466.41	467.47	467.47	467.47	466.06	466.31	466.29	467.03	466.73	427.22	427.68	427.69	427.31	427.53	427.60	427.81	426.99	427.00
G 24.0	430.50	437.07	439.23	449.68	463.33	471.01	473.30	472.57	468.05	470.76	470.76	471.82	471.82	471.82	470.41	470.66	470.64	471.38	471.08	430.50	430.96	430.97	430.59	430.81	430.88	431.09	430.27	430.28
G 25.0	433.75	440.46	442.33	452.83	467.20	475.04	477.53	477.62	472.80	475.20	475.20	476.26	476.26	476.26	474.85	475.10	475.08	475.82	475.52	433.75	434.21	434.22	433.84	434.06	434.13	434.34	433.52	433.53
G 26.0	436.79	443.66	446.10	455.89	469.48	477.23	481.01	482.62	478.27	479.83	479.83	480.89	480.89	480.89	479.48	479.73	479.71	480.47	480.17	436.79	437.25	437.26	436.88	437.10	437.17	437.38	436.56	436.57
G 27.0	439.41	446.49	450.11	458.78	470.50	478.11	483.86	487.34	484.26	484.58	484.58	485.64	485.64	485.64	484.23	484.48	484.46	485.22	484.92	439.41	439.87	439.88	439.50	439.72	439.79	439.99	439.17	439.18
G 28.0	441.42	448.74	453.87	461.37	470.79	478.39	486.25	491.52	490.45	489.39	489.39	490.45	490.45	490.45	489.04	489.29	489.27	490.03	489.73	441.42	441.88	441.89	441.51	441.73	441.80	442.01	441.19	441.20
G 29.0	442.58	450.24	456.86	463.57	470.86	478.79	488.32	494.90	496.53	494.17	494.17	495.23	495.23	495.23	493.82	494.07	494.05	494.81	494.51	442.58	443.04	443.05	442.67	442.89	442.96	443.17	442.35	442.36
G 30.0	442.69	450.80	458.56	465.27	471.23	480.02	490.26	497.23	502.19	498.86	498.86	499.92	499.92	499.92	498.51	498.76	498.74	499.50	499.20	442.69	443.15	443.16	442.78	443.00	443.07	443.28	442.46	442.47
G 31.0	441.63	450.28	458.62	466.36	472.23	482.54	492.16	497.28	507.17	503.37	503.37	504.43	504.43	504.43	503.02	503.27	503.25	504.01	503.71	441.63	442.09	442.10	441.72	441.94	442.01	442.22	441.40	441.41
G 32.0	439.64	448.83	457.40	466.73	473.53	485.76	493.89	497.32	511.35	507.71	507.71	508.77	508.77	508.77	507.36	507.61	507.59	508.35	508.05	439.64	440.10	440.11	439.73	439.95	440.02	440.23	439.41	439.42
G 33.0	437.03	446.65	455.41	466.26	474.60	488.83	495.27	497.37	514.69	511.87	511.87	512.93	512.93	512.93	511.52	511.77	511.75	512.51	512.21	437.03	437.49	437.50	437.12	437.34	437.41	437.62	436.80	436.81
G 34.0	434.14	443.96	453.16	464.81	474.92	490.89	496.10	497.42	517.11	515.84	515.84	516.90	516.90	516.90	515.49	515.74	515.72	516.48	516.18	434.14	434.60	434.61	434.23	434.45	434.52	434.73	433.91	433.92
G 35.0	431.30	440.96	451.18	462.28	473.96	491.08	496.20	497.47	518.56	519.64	519.64	520.70	520.70	520.70	519.29	519.54	519.52	520.28	520.08	431.30	431.76							



Apparecchio	Rilievo	Lampada
Codice ITALO 1 0F6 OP-DX 3.5-1M	Codice 18-009-8001	Codice L-IT1-0F6-3000-525-1M-70-25
Nome ITALO 1 0F6 OP-DX 3.5-1M	Nome ITALO 1 0F6 OP-DX 3.5-1M	Numero 1
Archivio Eulumdat	Data 23-07-2018	Posizione

Flusso Apparecchio	4800.00 lm	Potenza Apparecchio	39.00 W	Efficacia	123.08 lm/W	Rendimento	100.00%
--------------------	------------	---------------------	---------	-----------	-------------	------------	---------

Flusso Lampade	4800.00 lm	Valore Massimo	781.25 cd/klm	Posizione	C=65.00 G=56.00	CG	Asimmetrico
----------------	------------	----------------	---------------	-----------	-----------------	----	-------------

Tabella Intensità Luminose - cd/klm Tabella 2/18

	C 65.00	C 70.00	C 75.00	C 80.00	C 85.00	C 90.00	C 95.00	C 100.00	C 105.00	C 110.00	C 115.00	C 120.00	C 125.00
G 0.0	365.68	365.68	365.68	365.68	365.68	365.68	365.68	365.68	365.68	365.68	365.68	365.68	365.68
G 1.0	368.57	368.28	367.21	367.37	368.51	367.93	367.89	366.39	366.04	366.46	366.06	366.52	365.70
G 2.0	371.58	371.02	369.00	369.21	371.40	370.23	370.14	367.27	366.63	367.24	366.60	367.37	365.74
G 3.0	374.85	374.03	371.31	371.38	374.39	372.65	372.44	368.45	367.66	368.03	367.45	368.21	365.80
G 4.0	378.51	377.45	374.40	374.03	377.53	375.24	374.81	370.09	369.35	368.81	368.74	369.04	365.90
G 5.0	382.67	381.42	378.53	377.32	380.88	378.05	377.30	372.36	371.93	369.59	370.65	369.86	366.04
G 6.0	387.42	386.02	383.82	381.31	384.43	381.11	379.90	375.31	375.48	372.74	373.23	370.68	366.26
G 7.0	392.56	391.08	389.82	385.76	388.01	384.30	382.53	378.69	379.59	376.49	376.19	371.53	366.69
G 8.0	397.86	396.39	395.92	390.29	391.37	387.48	385.09	382.14	383.70	380.29	379.16	372.46	367.45
G 9.0	403.06	401.72	401.55	394.55	394.30	390.50	387.49	385.31	387.25	383.58	381.75	373.50	368.69
G 10.0	407.94	406.87	406.09	398.18	398.55	393.21	389.62	387.85	389.70	385.85	383.60	374.72	370.55
G 11.0	412.31	411.63	409.15	400.96	398.03	395.52	391.43	389.53	389.76	385.54	383.39	376.10	373.04
G 12.0	416.23	415.96	411.09	403.16	399.14	397.62	393.09	390.57	389.83	385.23	383.17	377.48	375.71
G 13.0	419.83	419.81	412.45	405.18	400.44	399.76	394.81	391.32	389.89	384.92	382.96	378.64	377.94
G 14.0	423.23	423.15	413.80	407.43	402.47	402.19	396.79	392.11	389.95	384.62	382.75	379.37	379.15
G 15.0	426.57	425.95	415.69	410.31	405.78	405.14	399.26	393.30	390.01	384.31	382.53	379.45	378.75
G 16.0	429.94	428.25	418.52	414.09	410.66	408.76	402.33	395.12	391.49	384.62	382.16	378.77	376.39
G 17.0	433.39	430.35	422.11	418.50	416.42	412.71	405.73	397.36	393.73	385.47	381.98	377.54	372.73
G 18.0	436.94	432.62	426.16	423.15	422.13	416.53	409.10	399.74	396.17	386.47	381.80	376.09	368.68
G 19.0	440.60	435.44	430.35	427.64	426.85	419.77	412.07	401.95	398.25	387.24	381.45	374.76	365.13
G 20.0	444.38	439.17	434.35	431.57	429.63	421.98	414.30	403.68	399.38	387.38	380.73	373.84	362.99
G 21.0	448.28	444.01	437.91	434.63	429.88	421.34	414.25	403.80	399.18	386.64	379.55	373.59	362.87
G 22.0	452.14	449.43	441.00	436.90	428.29	420.70	414.21	403.92	397.85	385.29	378.11	373.86	364.13
G 23.0	455.74	454.70	443.62	438.53	425.90	420.06	414.17	404.04	395.80	383.74	376.70	374.43	365.86
G 24.0	458.91	459.10	445.79	439.69	423.73	419.42	414.12	404.17	393.40	382.38	375.62	375.07	367.13
G 25.0	461.43	461.93	447.55	440.55	422.81	418.78	414.08	404.29	391.05	381.61	375.15	375.55	367.00
G 26.0	463.22	462.70	448.90	441.24	423.88	417.68	413.36	404.67	389.09	381.74	375.49	375.67	364.79
G 27.0	464.58	461.97	449.96	441.81	426.43	416.98	412.77	405.05	387.77	382.61	376.42	375.24	360.77
G 28.0	465.93	460.52	450.82	442.29	429.68	416.71	412.34	405.43	387.28	383.97	377.64	374.06	355.44
G 29.0	467.67	459.14	451.57	442.69	432.83	416.91	412.08	405.81	387.81	385.59	378.85	371.96	349.32
G 30.0	470.22	458.63	452.33	443.04	435.07	417.62	412.02	406.20	389.57	387.21	379.75	368.76	342.90
G 31.0	473.86	459.61	453.23	443.42	435.91	418.89	412.23	408.65	392.65	388.64	380.09	364.42	336.66
G 32.0	478.34	462.09	454.48	444.18	436.00	420.92	412.99	411.86	396.74	389.97	379.88	359.47	330.96
G 33.0	483.29	465.92	456.34	445.74	436.28	423.91	414.64	415.61	401.41	391.35	379.19	354.57	326.11
G 34.0	488.33	470.95	459.07	448.50	437.71	428.06	417.51	419.69	406.26	392.92	378.11	350.38	322.44
G 35.0	493.09	477.03	462.91	452.88	441.24	433.58	421.94	423.88	410.86	394.84	376.70	347.58	320.27
G 36.0	497.41	484.03	468.09	459.19	447.58	440.62	428.18	428.07	414.97	397.27	375.10	346.64	319.80
G 37.0	502.03	491.97	474.75	467.41	456.58	449.12	436.16	432.52	418.98	400.36	373.73	347.32	320.75
G 38.0	507.89	500.89	482.97	477.43	467.83	458.94	445.72	437.60	423.46	404.32	373.07	349.16	322.73
G 39.0	515.97	510.85	492.87	489.12	480.96	469.96	456.72	443.65	428.97	409.30	373.60	351.74	325.36
G 40.0	527.20	512.89	504.55	502.37	495.57	482.05	468.99	451.03	436.08	415.51	375.82	354.59	328.24
G 41.0	542.18	534.08	518.09	517.06	511.29	495.12	482.41	460.06	445.24	423.06	380.07	357.45	331.06
G 42.0	560.07	547.57	533.44	533.10	527.82	509.17	496.96	470.84	456.42	431.83	386.26	360.62	333.91
G 43.0	579.66	562.52	550.58	550.38	544.89	524.23	512.64	483.43	469.48	441.64	394.15	364.58	336.94
G 44.0	599.75	579.12	569.43	568.82	562.21	540.35	529.43	497.89	484.27	452.34	403.51	369.80	340.31
G 45.0	619.11	597.52	589.94	588.31	579.51	557.56	547.35	514.27	500.67	463.74	414.12	376.76	344.18
G 46.0	636.87	617.73	611.94	608.67	596.56	575.79	566.28	532.48	518.41	475.67	425.74	385.72	348.67
G 47.0	653.42	639.04	634.67	629.39	613.31	594.63	585.66	551.85	536.74	488.00	438.18	396.20	353.59
G 48.0	669.46	660.56	657.27	649.87	629.79	613.54	604.82	571.53	554.79	500.60	451.25	407.49	358.73
G 49.0	685.72	681.42	678.87	669.51	646.00	632.01	623.10	590.70	571.71	513.34	464.74	418.91	363.86
G 50.0	702.88	700.73	698.59	687.71	661.94	649.52	639.83	608.53	586.62	526.09	478.47	429.77	368.75
G 51.0	721.29	717.72	715.68	703.87	677.44	665.49	654.39	624.22	598.76	538.58	492.08	439.42	373.19
G 52.0	739.69	732.06	729.81	717.38	691.58	679.10	666.40	637.16	607.74	550.06	504.64	447.48	377.10
G 53.0	756.48	743.52	740.78	727.66	703.25	689.49	675.53	646.75	613.25	559.63	515.03	453.60	380.37
G 54.0	770.03	751.89	748.37	734.10	711.34	695.77	681.45	652.44	615.01	566.40	522.15	457.45	382.92
G 55.0	778.71	756.94	752.38	736.09	714.75	697.08	683.82	653.62	612.71	569.46	524.91	458.68	384.68
G 56.0	781.25	758.40	752.56	733.16	712.59	692.79	682.28	649.82	606.16	568.10	522.49	457.01	385.49
G 57.0	777.73	755.86	748.48	725.32	704.94	683.16	676.23	640.93	595.54	562.21	515.21	452.35	384.94
G 58.0	768.61	748.82	739.68	712.70	692.06	668.71	665.06	626.95	581.15	551.86	503.67	444.66	382.56
G 59.0	754.31	736.84	725.69	695.44	674.26	649.96	648.13	607.88	563.26	537.12	488.49	433.88	377.86
G 60.0	735.28	719.43	706.05	673.66	651.81	627.42	624.81	583.70	542.17	518.05	470.27	419.99	370.37
G 61.0	711.91	696.33	680.53	647.58	625.06	601.57	594.89	554.64	518.18	494.85	449.56	403.02	359.73
G 62.0	684.41	668.11	649.82	617.66	594.59	572.78	559.77	521.83	491.63	468.25	426.68	383.33	346.04
G 63.0	652.96	635.55	614.86	584.44	561.03	541.39	521.25	486.62	462.90	439.10	401.89	361.32	329.51
G 64.0	617.72	599.43	576.58	548.49	525.01	507.75	481.16	450.38	432.36	408.25	375.46	337.45	310.35
G 65.0	578.88	560.52	535.90	510.33	487.17	472.19	441.30	414.46	400.38	376.57	347.63	312.13	288.77
G 66.0	536.64	519.46	493.58	470.41	448.02	434.99	403.01	379.83	367.26	344.73	318.66	285.77	265.06
G 67.0	491.40	476.29	449.73	428.75	407.51	396.12	365.74	345.93	333.06	312.65	288.73	258.64	239.73
G 68.0	443.60	430.96	404.24	385.24	365.49	355.47	328.46	311.79	297.77	280.09	257.97	231.00	213.37
G 69.0	393.68	383.35	357.06	339.79	321.79	312.96	290.13	276.47	261.38	246.80	226.55	203.08	186.56
G 70.0	342.08	333.41	308.09	292.32	276.26	268.48	249.75	239.00	223.88	212.53	194.62	175.15	159.88
G 71.0	289.48	281.45	257.66	243.14	229.14	222.35	206.86	199.00	185.56	177.32	162.50	147.53	133.91
G 72.0	237.64	229.51	207.68	194.27	182.37	176.50	163.45	158.33	147.86	142.48	1		



Apparecchio	Rilievo	Lampada
Codice ITALO 1 0F6 OP-DX 3.5-1M	Codice 18-009-8001	Codice L-IT1-0F6-3000-525-1M-70-25
Nome ITALO 1 0F6 OP-DX 3.5-1M	Nome ITALO 1 0F6 OP-DX 3.5-1M	Numero 1
Archivio Eulumdat	Data 23-07-2018	Posizione

Flusso Apparecchio	4800.00 lm	Potenza Apparecchio	39.00 W	Efficacia	123.08 lm/W	Rendimento	100.00%
Flusso Lampade	4800.00 lm	Valore Massimo	781.25 cd/klm	Posizione	C=65.00 G=56.00	CG	Asimmetrico

	Tabella Intensità Luminose - cd/klm						Tabella 3/18						
	C 130.00	C 135.00	C 140.00	C 145.00	C 150.00	C 155.00	C 160.00	C 165.00	C 170.00	C 175.00	C 180.00	C 185.00	C 190.00
G 0.0	365.68	365.68	365.68	365.68	365.68	365.68	365.68	365.68	365.68	365.68	365.68	365.68	365.68
G 1.0	364.36	364.17	365.54	365.29	365.59	365.41	365.43	364.65	364.82	364.94	364.88	364.66	364.74
G 2.0	363.18	362.79	365.39	364.91	365.36	365.14	365.08	363.59	363.92	364.10	363.94	363.49	363.58
G 3.0	362.26	361.66	365.20	364.52	364.87	364.87	364.50	362.47	362.93	363.07	362.71	362.04	361.99
G 4.0	361.73	360.92	364.97	364.14	363.97	364.60	363.59	361.25	361.79	361.75	361.07	360.16	359.74
G 5.0	361.74	360.70	364.67	363.75	362.54	364.33	362.23	359.90	360.47	360.05	358.85	357.71	356.62
G 6.0	362.36	361.05	364.30	361.99	360.52	362.94	360.38	358.40	358.92	357.91	356.01	354.60	352.52
G 7.0	363.53	361.80	363.87	359.91	358.17	361.23	358.21	356.73	357.14	355.40	352.75	351.02	347.80
G 8.0	365.14	362.70	363.40	357.85	355.83	359.43	356.00	354.92	355.14	352.66	349.36	347.19	342.92
G 9.0	367.07	363.52	362.90	356.17	353.84	357.76	353.98	352.96	352.93	349.79	346.14	343.35	338.37
G 10.0	369.22	363.99	362.40	355.20	352.54	356.44	352.40	350.86	350.51	346.93	343.36	339.73	334.60
G 11.0	371.43	363.96	361.90	355.17	352.32	355.57	351.40	348.60	347.86	344.12	341.19	336.49	331.94
G 12.0	373.43	363.50	361.32	355.14	352.10	354.85	350.57	346.02	344.82	341.13	339.27	333.49	330.01
G 13.0	374.89	362.78	360.58	355.10	351.88	353.83	349.37	342.93	341.19	337.65	337.09	330.50	328.30
G 14.0	375.50	361.94	359.59	355.07	351.66	352.07	347.29	339.15	336.80	333.39	334.17	327.30	326.29
G 15.0	374.95	361.16	358.26	355.04	351.44	349.14	343.79	334.48	331.43	328.03	330.01	323.68	323.46
G 16.0	373.04	360.51	356.51	352.56	349.26	344.75	338.54	328.85	325.02	321.43	324.28	319.44	319.41
G 17.0	370.05	359.76	354.25	348.91	345.87	339.11	332.02	322.56	317.89	314.06	317.32	314.61	314.19
G 18.0	366.40	358.59	351.39	344.47	341.40	332.57	324.89	316.00	310.50	306.55	309.65	309.25	308.00
G 19.0	362.51	356.68	347.85	339.64	335.93	325.50	317.84	309.58	303.26	299.52	301.76	303.40	301.01
G 20.0	358.79	353.73	343.53	334.80	329.59	318.25	311.54	303.70	296.64	293.59	294.17	297.12	293.40
G 21.0	355.54	349.55	338.43	330.25	322.52	311.13	306.47	298.65	290.98	289.22	287.32	290.53	285.41
G 22.0	352.67	344.44	332.79	325.90	315.07	304.32	302.38	294.28	286.27	286.08	281.40	283.94	277.48
G 23.0	349.98	338.87	326.93	321.53	307.60	297.98	298.83	290.32	282.41	283.72	276.55	277.75	270.12
G 24.0	347.28	333.26	321.17	316.97	300.51	292.23	295.40	286.51	279.31	281.63	272.89	272.32	263.82
G 25.0	344.36	328.05	315.82	312.02	294.16	287.24	291.63	282.58	276.87	279.34	270.57	268.03	259.09
G 26.0	341.07	323.59	311.14	306.56	288.86	283.07	287.21	278.33	274.93	276.45	269.53	265.08	256.22
G 27.0	337.40	319.73	307.06	300.89	284.63	279.59	282.30	273.83	273.12	272.88	269.06	262.89	254.65
G 28.0	333.39	316.23	303.47	295.36	281.41	276.60	277.17	269.17	271.00	268.62	268.24	260.72	253.65
G 29.0	329.10	312.86	300.24	290.33	279.14	273.90	272.10	264.49	268.14	263.70	266.19	257.80	252.46
G 30.0	324.54	309.36	297.23	286.18	277.75	271.29	267.37	259.90	264.10	258.11	262.00	253.38	250.33
G 31.0	319.81	305.58	294.34	283.12	277.08	268.54	263.13	255.44	258.59	251.87	255.08	246.92	246.69
G 32.0	315.12	301.71	291.51	280.79	276.51	265.33	259.01	250.84	251.81	245.09	246.09	238.81	241.64
G 33.0	310.72	298.03	288.67	278.68	275.30	261.31	254.53	245.79	244.13	237.86	236.02	229.65	235.49
G 34.0	306.87	294.80	285.79	276.28	272.75	256.14	249.20	239.94	235.88	230.32	225.85	220.03	228.52
G 35.0	303.82	292.31	282.80	273.08	268.11	249.46	242.54	232.95	227.43	222.58	216.53	210.56	221.01
G 36.0	301.79	290.69	279.64	268.68	260.95	241.12	234.26	224.69	219.09	214.76	208.85	201.77	213.26
G 37.0	300.73	289.56	276.18	263.09	251.95	231.76	224.97	215.76	211.16	207.11	202.67	193.93	205.53
G 38.0	300.57	288.39	272.29	258.45	242.08	222.18	215.45	206.97	203.89	199.89	197.65	187.22	198.05
G 39.0	301.22	286.68	267.83	248.87	232.30	213.21	206.51	199.10	197.55	193.35	193.46	181.85	191.07
G 40.0	302.61	283.89	262.65	240.49	223.59	205.66	198.96	192.95	192.39	187.77	189.75	177.99	184.86
G 41.0	304.60	279.71	256.74	231.54	216.65	200.10	193.33	189.01	188.52	183.25	186.19	175.67	179.53
G 42.0	306.83	274.64	250.52	222.65	211.20	196.07	189.15	186.49	185.34	179.33	182.37	174.14	174.81
G 43.0	308.88	269.37	244.55	214.59	206.71	192.86	185.69	184.28	182.11	175.41	177.90	172.51	170.27
G 44.0	310.32	264.58	239.37	208.09	202.63	189.75	182.21	181.28	178.07	170.89	172.38	169.85	165.52
G 45.0	310.75	260.99	235.53	203.91	198.42	186.04	177.98	176.38	172.48	165.14	165.42	165.26	160.16
G 46.0	310.47	259.11	233.38	202.48	193.66	181.19	172.46	168.84	164.84	157.78	156.80	158.12	153.87
G 47.0	310.19	258.87	232.56	202.97	188.44	175.42	165.96	159.42	155.78	149.22	147.04	149.10	146.79
G 48.0	309.91	260.00	232.48	204.23	182.94	169.14	158.98	149.22	146.16	140.05	136.87	139.13	139.17
G 49.0	309.62	262.26	232.59	205.11	177.35	162.74	152.03	139.38	136.86	130.90	126.99	129.18	131.25
G 50.0	309.34	265.40	232.30	204.47	171.88	156.63	145.60	131.01	128.77	122.37	118.12	120.19	123.26
G 51.0	313.72	269.12	231.20	201.49	166.67	151.11	140.04	124.88	122.49	114.94	110.77	112.88	115.38
G 52.0	319.75	272.97	229.41	196.63	161.70	146.04	135.05	120.44	117.56	108.45	104.67	106.97	107.54
G 53.0	326.31	276.47	227.20	190.69	156.92	141.16	130.21	116.79	113.23	102.62	99.35	101.93	99.60
G 54.0	332.24	279.11	224.82	184.47	152.27	136.23	125.05	113.02	108.76	97.16	94.36	97.23	91.43
G 55.0	336.42	280.40	222.54	178.76	147.68	131.01	119.12	108.23	103.42	91.78	89.21	92.36	82.88
G 56.0	337.95	279.97	220.53	174.14	143.09	125.30	112.12	101.76	96.67	86.23	83.53	86.88	73.90
G 57.0	336.82	277.85	218.53	170.35	138.46	119.14	104.24	93.92	88.74	80.38	77.30	80.75	64.66
G 58.0	333.27	274.20	216.22	166.91	133.72	112.63	95.81	85.25	80.08	74.17	70.58	74.05	55.45
G 59.0	327.55	269.18	213.23	163.32	128.82	105.84	87.18	76.29	71.13	67.52	63.44	66.82	46.53
G 60.0	319.90	262.93	209.24	159.12	123.71	98.89	78.66	67.59	62.34	60.35	55.92	59.14	38.16
G 61.0	310.46	255.53	203.92	153.88	118.30	91.83	70.54	59.59	54.07	52.66	48.15	51.10	30.57
G 62.0	299.08	246.70	197.07	147.45	112.39	84.64	62.83	52.27	46.40	44.77	40.40	42.99	23.87
G 63.0	285.49	236.06	188.54	139.74	105.73	77.27	55.51	45.51	39.33	37.06	32.99	35.13	18.14
G 64.0	269.45	223.25	178.15	130.66	98.09	69.69	48.51	39.22	32.84	29.91	26.25	27.84	13.44
G 65.0	250.72	207.90	165.75	120.12	89.21	61.83	41.82	33.26	26.95	23.72	20.49	21.45	9.85
G 66.0	229.22	189.85	151.30	108.17	79.04	53.73	35.43	27.58	21.66	18.77	15.96	16.20	7.39
G 67.0	205.70	169.82	135.40	95.35	68.09	45.66	29.46	22.30	17.02	14.96	12.53	12.04	5.86
G 68.0	181.06	148.74	118.75	82.36	57.08	38.00	24.09	17.60	13.12	12.08	10.01	8.85	5.01
G 69.0	156.24	127.53	102.08	69.89	46.70	31.09	19.47	13.64	10.01	9.92	8.19	6.51	4.58
G 70.0	132.15	107.13	86.11	58.61	37.66	25.30	15.78	10.62	7.76	8.29	6.87	4.90	4.33
G 71.0	109.60	88.32	71.46	49.06	30.47	20.87	13.11	8.63	6.39	6.99	5.87	3.89	4.05
G 72.0	88.95	71.37	58.28	41.08	24.95	17.61	11.28	7.47	5.71	5.96	5.12	3.33	3.72



Apparecchio	Rilievo	Lampada
Codice ITALO 1 0F6 OP-DX 3.5-1M	Codice 18-009-8001	Codice L-IT1-0F6-3000-525-1M-70-25
Nome ITALO 1 0F6 OP-DX 3.5-1M	Nome ITALO 1 0F6 OP-DX 3.5-1M	Numero 1
Archivio Eulumdat	Data 23-07-2018	Posizione

Flusso Apparecchio	4800.00 lm	Potenza Apparecchio	39.00 W	Efficacia	123.08 lm/W	Rendimento	100.00%
Flusso Lampade	4800.00 lm	Valore Massimo	781.25 cd/klm	Posizione	C=65.00 G=56.00	CG	Asimmetrico

		Tabella Intensità Luminose - cd/klm						Tabella 4/18						
		C 195.00	C 200.00	C 205.00	C 210.00	C 215.00	C 220.00	C 225.00	C 230.00	C 235.00	C 240.00	C 245.00	C 250.00	C 255.00
G 0.0	365.68	365.68	365.68	365.68	365.68	365.68	365.68	365.68	365.68	365.68	365.68	365.68	365.68	365.68
G 1.0	364.95	363.58	364.09	363.14	362.33	362.04	362.66	363.88	364.83	365.01	364.86	364.48	364.38	363.48
G 2.0	363.97	361.39	362.40	360.54	359.07	358.53	359.65	361.95	363.74	364.09	363.90	363.23	363.23	361.37
G 3.0	362.48	359.03	360.47	357.81	356.01	355.26	356.64	359.73	362.16	362.69	362.64	361.88	361.88	359.43
G 4.0	360.22	356.39	358.19	354.88	353.23	352.36	353.64	357.09	359.83	360.57	360.95	360.37	360.37	357.77
G 5.0	356.94	353.39	355.45	351.69	350.83	349.96	350.63	353.87	356.53	357.48	358.68	358.66	358.66	356.46
G 6.0	352.52	350.00	352.19	348.21	348.86	348.11	347.66	350.05	352.16	353.33	355.75	356.67	356.67	355.51
G 7.0	347.37	346.40	348.62	344.63	347.15	346.65	344.84	346.01	347.29	348.62	352.35	354.30	354.30	354.49
G 8.0	342.05	342.83	345.00	341.16	345.45	345.33	342.34	342.22	342.67	344.01	348.76	351.43	351.43	352.91
G 9.0	337.13	339.53	341.58	338.01	343.57	343.93	340.31	339.17	339.05	340.15	345.24	347.95	347.95	350.26
G 10.0	333.16	336.76	338.62	335.41	341.25	342.20	338.91	337.35	337.14	337.70	342.04	343.74	343.74	346.04
G 11.0	330.50	334.64	336.30	333.48	338.36	339.96	338.16	336.93	334.08	336.86	339.11	338.46	338.46	339.64
G 12.0	328.77	332.92	334.37	331.99	335.04	337.23	337.49	336.90	331.01	336.00	335.06	330.98	330.98	330.08
G 13.0	327.40	331.22	332.48	330.58	331.50	334.06	336.23	335.93	327.94	333.05	328.15	319.95	319.95	316.30
G 14.0	325.82	329.19	330.29	328.94	327.97	330.53	333.68	332.68	324.88	325.94	316.66	304.02	297.22	297.22
G 15.0	323.46	326.45	327.45	326.72	324.65	326.69	329.16	325.83	321.81	312.60	298.87	281.84	271.76	271.76
G 16.0	319.86	322.71	323.70	323.66	321.62	322.46	322.04	314.36	304.46	291.61	273.73	252.72	239.53	239.53
G 17.0	315.11	317.96	319.04	319.72	318.30	317.18	312.02	298.41	280.98	264.22	242.82	218.66	202.83	202.83
G 18.0	309.40	312.25	313.53	314.95	313.96	310.04	298.86	278.44	252.90	232.32	208.41	182.32	164.65	164.65
G 19.0	302.92	305.65	307.26	309.38	307.88	300.21	282.34	254.91	221.74	197.84	172.78	146.35	127.96	127.96
G 20.0	295.89	298.20	300.28	303.05	299.31	286.89	262.21	228.25	189.03	162.67	138.17	113.42	95.75	95.75
G 21.0	288.52	290.04	292.70	295.92	287.72	269.52	238.45	199.10	156.26	128.61	106.57	85.68	70.33	70.33
G 22.0	281.10	281.62	284.67	287.69	273.31	248.56	211.92	168.72	124.73	96.98	78.79	63.20	51.32	51.32
G 23.0	273.95	273.48	276.37	277.97	256.45	224.71	183.67	138.55	95.70	68.99	55.33	45.58	37.68	37.68
G 24.0	267.37	266.15	267.99	266.40	237.53	198.70	154.76	110.04	70.43	45.84	36.71	32.39	28.36	28.36
G 25.0	261.68	260.16	259.70	252.58	216.92	171.24	126.24	84.61	50.19	28.75	23.45	23.21	22.31	22.31
G 26.0	257.10	255.86	251.60	236.34	195.03	143.14	99.15	63.41	35.81	25.95	21.66	21.29	18.57	18.57
G 27.0	253.43	252.83	243.38	218.21	172.33	115.52	74.35	46.38	26.46	23.16	19.86	19.37	16.50	16.50
G 28.0	250.41	250.51	234.66	198.93	149.30	89.64	52.68	33.14	20.89	20.37	18.07	17.44	15.52	15.52
G 29.0	247.75	248.29	225.07	179.23	126.44	66.72	34.97	23.33	17.84	17.57	16.28	15.52	15.07	15.07
G 30.0	245.17	245.59	214.21	159.85	104.23	47.99	22.08	16.58	16.05	14.78	14.49	13.60	14.60	14.60
G 31.0	242.39	241.87	201.80	141.38	83.17	34.32	20.18	15.30	14.49	13.61	13.30	13.17	13.65	13.65
G 32.0	239.21	236.82	188.01	123.82	63.84	25.06	18.29	14.02	12.97	12.43	12.12	12.23	12.29	12.29
G 33.0	235.41	230.16	173.10	107.04	46.81	19.18	16.39	12.73	11.53	11.26	10.93	10.99	10.73	10.73
G 34.0	230.78	221.62	157.33	90.90	32.68	15.66	14.50	11.45	10.21	10.09	9.74	9.65	9.14	9.14
G 35.0	225.12	210.95	140.96	75.26	22.03	13.48	12.61	10.17	9.04	8.91	8.56	8.41	7.73	7.73
G 36.0	218.28	198.00	124.29	60.11	19.61	11.78	11.55	10.00	8.06	7.74	7.21	7.43	6.64	6.64
G 37.0	210.39	183.27	107.62	45.92	17.19	10.37	10.50	9.45	7.23	6.99	6.27	6.69	5.84	5.84
G 38.0	201.63	167.35	91.29	33.25	14.77	9.22	9.45	8.67	6.53	6.54	5.66	6.13	5.27	5.27
G 39.0	192.19	150.87	75.62	22.70	12.35	8.31	8.40	7.80	5.94	6.23	5.32	5.67	4.86	4.86
G 40.0	182.26	134.45	60.96	14.85	9.94	7.60	7.35	6.99	5.41	5.91	5.17	5.26	4.52	4.52
G 41.0	172.00	118.60	47.62	13.45	9.69	7.07	6.36	6.36	4.94	5.49	5.15	4.84	4.21	4.21
G 42.0	161.49	103.46	35.84	12.05	9.04	6.67	5.77	5.90	4.51	4.97	5.14	4.43	3.92	3.92
G 43.0	150.77	89.07	25.83	10.65	8.15	6.34	5.45	5.56	4.14	4.43	5.13	4.05	3.66	3.66
G 44.0	139.90	75.48	17.81	9.25	7.17	6.02	5.27	5.29	3.83	3.92	5.11	3.74	3.44	3.44
G 45.0	128.93	62.71	12.02	7.85	6.27	5.67	5.10	5.05	3.59	3.51	5.10	3.51	3.27	3.27
G 46.0	117.92	50.85	11.10	7.25	5.59	5.25	4.83	4.80	3.43	3.22	4.81	3.38	3.14	3.14
G 47.0	106.91	40.10	10.19	6.66	5.10	4.78	4.49	4.55	3.33	3.07	4.42	3.33	3.07	3.07
G 48.0	95.95	30.68	9.28	6.06	4.77	4.32	4.15	4.30	3.27	3.02	3.98	3.32	3.02	3.02
G 49.0	85.12	22.84	8.37	5.47	4.55	3.92	3.86	4.08	3.26	3.04	3.58	3.33	3.00	3.00
G 50.0	74.45	16.79	7.45	4.87	4.41	3.63	3.69	3.89	3.26	3.12	3.28	3.30	2.99	2.99
G 51.0	64.02	12.67	7.14	4.84	4.29	3.61	3.68	3.75	3.27	3.24	3.26	3.22	2.99	2.99
G 52.0	54.03	10.16	6.84	4.80	4.20	3.59	3.77	3.64	3.29	3.35	3.24	3.10	2.98	2.98
G 53.0	44.67	8.83	6.53	4.76	4.15	3.57	3.89	3.55	3.31	3.45	3.23	2.96	2.97	2.97
G 54.0	36.15	8.25	6.22	4.73	4.13	3.55	3.98	3.45	3.33	3.49	3.21	2.82	2.94	2.94
G 55.0	28.68	8.00	5.91	4.69	4.15	3.53	3.96	3.33	3.35	3.45	3.19	2.72	2.89	2.89
G 56.0	22.41	7.72	5.30	4.55	4.20	3.48	3.79	3.17	3.36	3.31	3.08	2.66	2.82	2.82
G 57.0	17.30	7.37	4.76	4.41	4.27	3.37	3.51	2.99	3.37	3.11	2.90	2.64	2.74	2.74
G 58.0	13.22	6.99	4.30	4.27	4.33	3.23	3.20	2.82	3.37	2.88	2.70	2.62	2.66	2.66
G 59.0	10.09	6.59	3.96	4.13	4.36	3.07	2.91	2.69	3.36	2.68	2.50	2.59	2.59	2.59
G 60.0	7.79	6.22	3.77	3.98	4.34	2.93	2.73	2.62	3.34	2.53	2.34	2.54	2.55	2.55
G 61.0	6.20	5.89	3.74	3.87	4.23	2.81	2.69	2.63	3.30	2.47	2.35	2.43	2.54	2.54
G 62.0	5.21	5.59	3.82	3.80	4.06	2.73	2.77	2.69	3.25	2.49	2.36	2.31	2.56	2.56
G 63.0	4.66	5.30	3.94	3.74	3.85	2.69	2.89	2.78	3.17	2.53	2.36	2.18	2.58	2.58
G 64.0	4.42	5.00	4.04	3.65	3.61	2.71	3.01	2.86	3.05	2.58	2.37	2.09	2.59	2.59
G 65.0	4.35	4.68	4.05	3.52	3.37	2.78	3.06	2.91	2.89	2.60	2.38	2.05	2.58	2.58
G 66.0	4.32	4.31	3.91	3.32	3.14	2.91	2.99	2.89	2.69	2.56	2.41	2.09	2.52	2.52
G 67.0	4.28	3.93	3.67	3.08	2.94	3.08	2.84	2.82	2.47	2.48	2.41	2.16	2.43	2.43
G 68.0	4.22	3.57	3.38	2.84	2.79	3.23	2.65	2.72	2.25	2.39	2.39	2.24	2.31	2.31
G 69.0	4.08	3.28	3.09	2.63	2.71	3.32	2.45	2.61	2.06	2.29	2.34	2.28	2.17	2.17
G 70.0	3.86	3.09	2.86	2.49	2.71	3.33	2.30	2.52	1.93	2.23	2.26	2.23	2.02	2.02
G 71.0	3.52	3.08	2.74	2.44	2.81	3.23	2.23	2.46	1.88	2.21	2.16	2.07	1.88	1.88
G 72.0	3.12	3.07	2.69	2.46	2.97	3.04	2.22	2.41	1.89	2.21	2.03	1.83	1.74	1.74



Apparecchio	Rilievo	Lampada
Codice ITALO 1 0F6 OP-DX 3.5-1M	Codice 18-009-8001	Codice L-IT1-0F6-3000-525-1M-70-25
Nome ITALO 1 0F6 OP-DX 3.5-1M	Nome ITALO 1 0F6 OP-DX 3.5-1M	Numero 1
Archivio Eulumdat	Data 23-07-2018	Posizione

Flusso Apparecchio	4800.00 lm	Potenza Apparecchio	39.00 W	Efficacia	123.08 lm/W	Rendimento	100.00%
Flusso Lampade	4800.00 lm	Valore Massimo	781.25 cd/klm	Posizione	C=65.00 G=56.00	CG	Asimmetrico

	Tabella Intensità Luminose - cd/klm						Tabella 5/18						
	C 260.00	C 265.00	C 270.00	C 275.00	C 280.00	C 285.00	C 290.00	C 295.00	C 300.00	C 305.00	C 310.00	C 315.00	C 320.00
G 0.0	365.68	365.68	365.68	365.68	365.68	365.68	365.68	365.68	365.68	365.68	365.68	365.68	365.68
G 1.0	363.47	363.20	363.06	363.55	363.33	363.84	364.72	365.25	365.45	366.47	365.76	366.02	366.46
G 2.0	361.36	360.88	360.59	361.58	361.15	362.10	363.77	364.75	365.23	367.16	365.88	366.45	367.34
G 3.0	359.47	358.84	358.40	359.94	359.29	360.53	362.81	364.10	365.00	367.62	366.09	367.03	368.44
G 4.0	357.89	357.25	356.66	358.80	357.91	359.23	361.85	363.25	364.77	367.74	366.44	367.85	369.85
G 5.0	356.74	356.25	355.50	358.30	357.19	358.27	360.88	362.12	364.55	367.41	366.96	368.98	371.68
G 6.0	356.00	355.84	354.92	356.82	357.13	357.68	359.89	360.68	362.79	366.60	367.68	370.46	373.98
G 7.0	355.17	355.41	354.34	355.34	357.17	357.16	358.80	359.04	360.71	365.52	368.55	372.13	376.52
G 8.0	353.64	354.20	353.03	353.86	356.59	356.31	357.49	357.38	358.73	364.51	369.48	373.80	379.03
G 9.0	350.79	351.47	350.25	352.38	354.67	354.78	355.86	355.85	357.28	363.84	370.41	375.24	381.20
G 10.0	346.01	346.45	345.27	350.90	350.70	352.18	353.82	354.60	356.77	363.85	371.26	376.28	382.77
G 11.0	338.60	338.39	337.34	342.90	343.94	347.96	351.00	353.48	352.43	360.56	371.84	376.68	383.50
G 12.0	327.65	326.50	325.66	330.96	333.57	340.89	346.04	351.02	348.10	357.27	371.50	376.18	383.41
G 13.0	312.14	309.97	309.41	314.42	318.72	329.59	337.31	345.41	343.76	353.98	369.48	374.48	382.56
G 14.0	291.09	288.01	287.77	292.64	298.56	312.66	323.19	334.87	339.42	350.69	365.03	371.31	381.01
G 15.0	263.48	259.83	259.92	264.94	272.24	288.69	302.06	317.60	335.08	347.40	357.37	366.38	378.83
G 16.0	229.05	225.29	225.71	231.27	239.52	257.05	273.05	292.49	314.66	331.17	345.87	359.37	375.93
G 17.0	190.38	186.90	187.64	193.93	202.71	220.15	238.28	261.19	287.82	309.34	330.38	349.81	371.59
G 18.0	150.80	147.87	148.85	155.84	164.73	181.15	200.60	226.05	256.18	282.72	310.84	337.20	364.94
G 19.0	113.62	111.37	112.52	119.91	128.51	143.21	162.88	189.39	221.38	252.10	287.23	321.05	355.10
G 20.0	82.16	80.58	81.80	89.04	96.97	109.50	127.98	153.56	185.07	218.31	259.49	300.86	341.20
G 21.0	58.91	57.89	59.06	65.43	72.35	82.48	98.24	120.60	148.87	182.37	227.94	276.41	322.65
G 22.0	43.04	42.46	43.49	48.49	54.18	61.87	73.86	91.41	114.45	146.23	194.23	248.56	300.00
G 23.0	32.92	32.66	33.50	36.90	41.27	46.67	54.49	66.59	83.44	112.08	160.36	218.46	274.10
G 24.0	26.89	26.83	27.48	29.36	32.48	35.90	39.80	46.74	57.52	82.09	128.35	187.26	245.78
G 25.0	23.30	23.35	23.85	24.55	26.63	28.57	29.46	32.45	38.34	58.43	100.18	156.11	215.89
G 26.0	20.75	20.82	21.24	21.33	22.69	23.76	23.02	30.23	35.39	42.62	77.42	126.14	185.32
G 27.0	18.81	18.85	19.26	19.19	20.10	20.83	19.60	28.02	32.45	33.41	59.78	98.38	155.21
G 28.0	17.30	17.29	17.74	17.80	18.47	19.21	18.25	25.80	29.51	28.92	46.54	73.87	126.75
G 29.0	16.04	15.98	16.52	16.81	17.37	18.34	17.98	23.58	26.57	27.25	36.97	53.63	101.12
G 30.0	14.83	14.78	15.45	15.89	16.39	17.64	17.83	21.36	23.62	26.48	30.35	38.69	79.52
G 31.0	13.54	13.58	14.39	14.77	15.20	16.66	17.01	19.85	21.71	25.09	25.98	35.92	62.79
G 32.0	12.17	12.37	13.31	13.46	13.82	15.38	15.60	18.34	19.80	23.01	23.28	33.15	50.42
G 33.0	10.80	11.20	12.21	12.08	12.37	13.92	13.88	16.84	17.89	20.52	21.68	30.38	41.55
G 34.0	9.46	10.10	11.08	10.71	10.96	12.39	12.11	15.33	15.97	17.92	20.65	27.61	35.34
G 35.0	8.23	9.11	9.91	9.46	9.69	10.88	10.57	13.82	14.06	15.51	19.62	24.84	30.92
G 36.0	7.14	8.24	8.71	8.39	8.66	9.50	9.46	12.06	12.15	13.52	18.16	23.91	27.54
G 37.0	6.22	7.51	7.54	7.50	7.84	8.27	8.74	10.67	10.84	11.94	16.36	21.85	24.90
G 38.0	5.49	6.88	6.43	6.79	7.16	7.20	8.27	9.56	9.93	10.68	14.38	19.15	22.78
G 39.0	4.96	6.34	5.46	6.23	6.57	6.31	7.93	8.68	9.23	9.67	12.44	16.30	20.98
G 40.0	4.65	5.87	4.68	5.80	6.02	5.60	7.59	7.94	8.55	8.84	10.71	13.79	19.28
G 41.0	4.55	5.45	4.13	5.49	5.47	5.09	7.17	7.29	7.76	8.12	9.36	11.99	17.54
G 42.0	4.61	5.08	3.77	5.26	4.93	4.73	6.67	6.69	6.88	7.49	8.33	10.82	15.77
G 43.0	4.74	4.74	3.56	5.09	4.44	4.50	6.13	6.16	6.02	6.96	7.57	10.06	14.04
G 44.0	4.87	4.45	3.45	4.95	4.02	4.34	5.60	5.69	5.25	6.51	6.98	9.50	12.43
G 45.0	4.90	4.19	3.40	4.81	3.71	4.22	5.13	5.27	4.67	6.14	6.49	8.94	11.01
G 46.0	4.80	3.95	3.39	4.65	3.52	4.11	4.73	4.91	4.33	5.84	6.04	8.22	9.83
G 47.0	4.56	3.76	3.37	4.46	3.43	4.00	4.40	4.59	4.18	5.59	5.62	7.37	8.87
G 48.0	4.25	3.60	3.36	4.25	3.40	3.89	4.12	4.31	4.15	5.36	5.23	6.51	8.07
G 49.0	3.90	3.50	3.35	4.00	3.39	3.79	3.85	4.07	4.14	5.13	4.90	5.71	7.39
G 50.0	3.54	3.45	3.33	3.72	3.36	3.69	3.58	3.87	4.08	4.86	4.61	5.07	6.79
G 51.0	3.23	3.47	3.33	3.41	3.29	3.61	3.28	3.71	3.90	4.54	4.39	4.65	6.22
G 52.0	2.97	3.51	3.33	3.10	3.17	3.54	2.99	3.57	3.64	4.19	4.21	4.43	5.69
G 53.0	2.77	3.55	3.33	2.82	3.02	3.46	2.72	3.44	3.34	3.82	4.06	4.33	5.21
G 54.0	2.64	3.55	3.33	2.60	2.87	3.37	2.51	3.32	3.04	3.47	3.94	4.29	4.78
G 55.0	2.60	3.46	3.33	2.48	2.72	3.27	2.39	3.20	2.79	3.16	3.83	4.24	4.41
G 56.0	2.65	3.26	3.20	2.47	2.58	3.15	2.38	3.07	2.63	2.91	3.71	4.14	4.11
G 57.0	2.74	2.99	3.01	2.54	2.47	3.02	2.44	2.93	2.54	2.71	3.59	3.98	3.87
G 58.0	2.86	2.69	2.80	2.65	2.37	2.88	2.53	2.79	2.49	2.57	3.47	3.77	3.66
G 59.0	2.94	2.41	2.58	2.73	2.29	2.75	2.61	2.65	2.47	2.47	3.34	3.53	3.47
G 60.0	2.96	2.18	2.38	2.75	2.21	2.63	2.62	2.50	2.45	2.40	3.21	3.26	3.27
G 61.0	2.89	2.15	2.21	2.67	2.15	2.54	2.55	2.36	2.42	2.37	3.08	2.97	3.06
G 62.0	2.75	2.11	2.07	2.51	2.09	2.45	2.40	2.23	2.37	2.34	2.95	2.69	2.84
G 63.0	2.56	2.07	1.97	2.31	2.03	2.38	2.21	2.12	2.32	2.30	2.81	2.43	2.63
G 64.0	2.36	2.04	1.88	2.10	1.96	2.30	2.03	2.02	2.27	2.24	2.65	2.21	2.45
G 65.0	2.19	2.00	1.81	1.93	1.90	2.22	1.87	1.94	2.25	2.13	2.49	2.04	2.32
G 66.0	2.05	1.96	1.75	1.81	1.82	2.12	1.78	1.89	2.24	1.96	2.31	1.94	2.23
G 67.0	1.96	1.89	1.69	1.75	1.74	2.01	1.72	1.86	2.24	1.75	2.14	1.89	2.19
G 68.0	1.88	1.81	1.64	1.70	1.67	1.91	1.70	1.84	2.24	1.55	1.99	1.87	2.17
G 69.0	1.81	1.74	1.59	1.66	1.61	1.83	1.69	1.83	2.20	1.39	1.88	1.85	2.15
G 70.0	1.74	1.68	1.54	1.60	1.57	1.77	1.66	1.81	2.11	1.30	1.84	1.80	2.11
G 71.0	1.64	1.65	1.49	1.49	1.56	1.74	1.60	1.79	1.96	1.31	1.86	1.72	2.04
G 72.0	1.53	1.64	1.44	1.37	1.55	1.74	1.53	1.76	1.78	1.39	1.94	1.61	1.93



Apparecchio	Rilievo	Lampada
Codice ITALO 1 0F6 OP-DX 3.5-1M	Codice 18-009-8001	Codice L-IT1-0F6-3000-525-1M-70-25
Nome ITALO 1 0F6 OP-DX 3.5-1M	Nome ITALO 1 0F6 OP-DX 3.5-1M	Numero 1
Archivio Eulumdat	Data 23-07-2018	Posizione

Flusso Apparecchio	4800.00 lm	Potenza Apparecchio	39.00 W	Efficacia	123.08 lm/W	Rendimento	100.00%
Flusso Lampade	4800.00 lm	Valore Massimo	781.25 cd/klm	Posizione	C=65.00 G=56.00	CG	Asimmetrico

	Tabella Intensità Luminose - cd/klm				Tabella 6/18			
	C 325.00	C 330.00	C 335.00	C 340.00	C 345.00	C 350.00	C 355.00	
G 0.0	365.68	365.68	365.68	365.68	365.68	365.68	365.68	
G 1.0	366.93	368.26	369.32	369.99	370.13	369.94	370.08	
G 2.0	368.31	370.89	372.84	374.09	374.40	374.07	374.34	
G 3.0	369.97	373.62	376.12	377.74	378.30	377.95	378.34	
G 4.0	372.02	376.50	379.04	380.72	381.66	381.46	381.93	
G 5.0	374.62	379.56	381.48	382.83	384.29	384.47	384.99	
G 6.0	377.80	382.83	383.38	383.94	386.09	386.89	387.45	
G 7.0	381.30	386.11	384.91	384.40	387.29	388.85	389.47	
G 8.0	384.74	389.18	386.31	384.67	388.21	390.51	391.30	
G 9.0	387.78	391.81	387.81	385.20	389.14	392.02	393.17	
G 10.0	390.05	393.78	389.66	386.45	390.39	393.55	395.31	
G 11.0	391.29	394.92	391.99	388.71	392.21	395.23	397.89	
G 12.0	391.58	395.34	394.50	391.68	394.50	397.04	400.72	
G 13.0	391.14	395.20	396.80	394.85	397.09	398.95	403.57	
G 14.0	390.14	394.66	398.51	397.76	399.82	400.90	406.16	
G 15.0	388.79	393.88	399.22	399.93	402.52	402.86	408.26	
G 16.0	387.14	392.99	398.70	399.76	405.02	404.80	409.71	
G 17.0	384.69	391.93	397.27	399.60	407.21	406.70	410.76	
G 18.0	380.82	390.62	395.43	399.44	408.97	408.60	411.75	
G 19.0	374.89	388.97	393.66	399.27	410.18	410.50	413.06	
G 20.0	366.26	386.88	392.45	399.11	410.72	412.41	415.02	
G 21.0	354.48	384.16	392.07	398.57	410.54	414.34	417.86	
G 22.0	339.70	380.15	391.97	398.24	409.81	416.28	421.31	
G 23.0	322.28	374.07	391.40	398.03	408.78	418.20	424.97	
G 24.0	302.53	365.15	389.60	397.83	407.69	420.09	428.45	
G 25.0	280.79	352.63	385.81	397.56	406.78	421.91	431.33	
G 26.0	257.39	336.00	379.44	397.08	406.65	423.62	433.31	
G 27.0	232.68	315.83	370.49	396.13	406.53	424.98	434.42	
G 28.0	206.96	292.95	359.14	394.40	406.41	425.74	434.75	
G 29.0	180.59	268.20	345.56	391.61	406.28	425.64	434.43	
G 30.0	153.88	242.43	329.93	387.45	406.16	424.41	433.55	
G 31.0	127.31	216.38	312.40	381.63	404.59	421.92	432.22	
G 32.0	101.85	190.48	293.18	373.90	403.03	418.45	430.47	
G 33.0	78.64	165.08	272.42	364.00	401.47	414.43	428.32	
G 34.0	58.80	140.54	250.31	351.68	399.90	410.27	425.78	
G 35.0	43.44	117.19	227.03	336.71	398.34	406.39	422.87	
G 36.0	33.30	95.42	202.83	318.97	392.81	403.04	419.59	
G 37.0	27.49	75.70	178.26	299.03	385.42	399.95	415.84	
G 38.0	24.73	58.54	153.97	277.57	376.12	396.69	411.50	
G 39.0	23.75	44.42	130.57	255.29	364.85	392.82	406.45	
G 40.0	23.27	33.87	108.71	232.90	351.56	387.92	400.56	
G 41.0	22.25	27.14	88.92	210.96	336.25	381.62	393.73	
G 42.0	20.68	23.50	71.47	189.49	319.23	373.90	385.90	
G 43.0	18.80	22.00	56.51	168.39	300.87	364.79	377.07	
G 44.0	16.85	21.68	44.21	147.55	281.54	354.32	367.20	
G 45.0	15.05	21.56	34.74	126.86	261.60	342.54	356.25	
G 46.0	13.59	20.89	28.12	106.36	241.36	329.51	344.25	
G 47.0	12.43	19.64	23.84	86.66	220.85	315.35	331.38	
G 48.0	11.48	18.01	21.25	68.50	200.00	300.23	317.86	
G 49.0	10.65	16.19	19.68	52.66	178.76	284.30	303.91	
G 50.0	9.85	14.35	18.49	39.89	157.09	267.71	289.76	
G 51.0	9.00	12.64	17.14	30.68	135.06	250.59	275.58	
G 52.0	8.12	11.12	15.61	24.51	113.32	233.01	261.35	
G 53.0	7.25	9.79	14.00	20.59	92.63	214.99	247.00	
G 54.0	6.42	8.65	12.42	18.14	73.78	196.56	232.46	
G 55.0	5.66	7.72	10.97	16.38	57.52	177.75	217.66	
G 56.0	5.01	7.00	9.72	14.65	44.45	158.66	202.59	
G 57.0	4.47	6.43	8.67	12.90	34.29	139.59	187.41	
G 58.0	4.02	5.95	7.79	11.20	26.58	120.90	172.36	
G 59.0	3.66	5.51	7.04	9.61	20.89	102.96	157.66	
G 60.0	3.38	5.04	6.38	8.22	16.73	86.12	143.55	
G 61.0	3.16	4.50	5.80	7.08	13.69	70.70	130.18	
G 62.0	3.00	3.93	5.26	6.17	11.52	56.86	117.40	
G 63.0	2.86	3.38	4.77	5.44	9.98	44.68	104.96	
G 64.0	2.75	2.91	4.30	4.87	8.87	34.28	92.63	
G 65.0	2.63	2.58	3.84	4.42	7.94	25.74	80.18	
G 66.0	2.50	2.54	3.39	4.04	7.03	19.11	67.51	
G 67.0	2.35	2.51	2.96	3.72	6.13	14.15	55.00	
G 68.0	2.21	2.48	2.56	3.46	5.26	10.55	43.16	
G 69.0	2.07	2.44	2.22	3.23	4.46	8.01	32.51	
G 70.0	1.95	2.41	1.94	3.02	3.75	6.23	23.56	
G 71.0	1.85	2.26	1.73	2.83	3.16	4.94	16.89	
G 72.0	1.77	2.03	1.60	2.64	2.68	4.02	11.68	



Apparecchio	Rilievo	Lampada
Codice ITALO 1 0F6 OP-DX 3.5-1M	Codice 18-009-8001	Codice L-IT1-0F6-3000-525-1M-70-25
Nome ITALO 1 0F6 OP-DX 3.5-1M	Nome ITALO 1 0F6 OP-DX 3.5-1M	Numero 1
Archivio Eulumdat	Data 23-07-2018	Posizione

Flusso Apparecchio	4800.00 lm	Potenza Apparecchio	39.00 W	Efficacia	123.08 lm/W	Rendimento	100.00%
Flusso Lampade	4800.00 lm	Valore Massimo	781.25 cd/klm	Posizione	C=65.00 G=56.00	CG	Asimmetrico

Tabella Intensità Luminose - cd/klm Tabella 7/18

	C 0.00	C 5.00	C 10.00	C 15.00	C 20.00	C 25.00	C 30.00	C 35.00	C 40.00	C 45.00	C 50.00	C 55.00	C 60.00
G 73.0	11.31	14.98	23.08	34.53	56.17	83.69	115.83	147.88	175.73	187.91	199.42	211.67	203.21
G 74.0	8.20	11.41	17.73	27.11	44.88	68.72	96.23	120.84	143.49	154.70	160.64	169.39	161.09
G 75.0	6.03	8.80	13.62	21.15	35.18	55.38	78.36	96.44	114.19	124.42	126.42	131.81	124.17
G 76.0	4.59	6.93	10.67	16.61	27.32	44.04	62.46	75.45	88.82	97.47	97.60	100.11	93.54
G 77.0	3.72	5.64	8.65	13.26	21.13	34.60	48.59	57.82	67.38	73.99	73.87	74.09	68.86
G 78.0	3.23	4.76	7.30	10.82	16.31	26.82	36.72	43.27	49.62	54.05	54.67	53.19	49.39
G 79.0	2.97	4.15	6.34	9.00	12.55	20.49	26.84	31.54	35.29	37.69	39.43	36.85	34.38
G 80.0	2.75	3.64	5.50	7.51	9.56	15.37	18.95	22.36	24.15	25.00	27.57	24.51	23.12
G 81.0	2.44	3.12	4.58	6.12	7.09	11.26	12.96	15.44	15.91	15.90	18.54	15.60	14.90
G 82.0	2.05	2.57	3.60	4.81	5.05	8.02	8.63	10.43	10.10	9.82	11.90	9.51	9.16
G 83.0	1.62	2.04	2.63	3.62	3.42	5.52	5.61	6.94	6.23	6.06	7.24	5.63	5.41
G 84.0	1.19	1.53	1.74	2.57	2.17	3.66	3.60	4.60	3.80	3.92	4.12	3.34	3.11
G 85.0	0.82	1.09	1.03	1.72	1.25	2.31	2.27	3.03	2.30	2.70	2.13	2.03	1.75
G 86.0	0.53	0.73	0.53	1.07	1.00	1.36	1.35	1.91	1.31	1.82	1.71	1.16	0.89
G 87.0	0.31	0.46	0.24	0.61	0.75	0.73	0.72	1.13	0.68	1.13	1.29	0.59	0.37
G 88.0	0.17	0.25	0.08	0.31	0.50	0.35	0.33	0.60	0.32	0.62	0.87	0.25	0.11
G 89.0	0.07	0.11	0.02	0.12	0.25	0.15	0.11	0.29	0.14	0.26	0.45	0.08	0.01
G 90.0	0.00	0.00	0.00	0.00	0.00	0.00	0.00	0.00	0.00	0.00	0.00	0.00	0.00
G 91.0	0.00	0.00	0.00	0.00	0.00	0.00	0.00	0.00	0.00	0.00	0.00	0.00	0.00
G 92.0	0.00	0.00	0.00	0.00	0.00	0.00	0.00	0.00	0.00	0.00	0.00	0.00	0.00
G 93.0	0.00	0.00	0.00	0.00	0.00	0.00	0.00	0.00	0.00	0.00	0.00	0.00	0.00
G 94.0	0.00	0.00	0.00	0.00	0.00	0.00	0.00	0.00	0.00	0.00	0.00	0.00	0.00
G 95.0	0.00	0.00	0.00	0.00	0.00	0.00	0.00	0.00	0.00	0.00	0.00	0.00	0.00
G 96.0	0.00	0.00	0.00	0.00	0.00	0.00	0.00	0.00	0.00	0.00	0.00	0.00	0.00
G 97.0	0.00	0.00	0.00	0.00	0.00	0.00	0.00	0.00	0.00	0.00	0.00	0.00	0.00
G 98.0	0.00	0.00	0.00	0.00	0.00	0.00	0.00	0.00	0.00	0.00	0.00	0.00	0.00
G 99.0	0.00	0.00	0.00	0.00	0.00	0.00	0.00	0.00	0.00	0.00	0.00	0.00	0.00
G100.0	0.00	0.00	0.00	0.00	0.00	0.00	0.00	0.00	0.00	0.00	0.00	0.00	0.00
G101.0	0.00	0.00	0.00	0.00	0.00	0.00	0.00	0.00	0.00	0.00	0.00	0.00	0.00
G102.0	0.00	0.00	0.00	0.00	0.00	0.00	0.00	0.00	0.00	0.00	0.00	0.00	0.00
G103.0	0.00	0.00	0.00	0.00	0.00	0.00	0.00	0.00	0.00	0.00	0.00	0.00	0.00
G104.0	0.00	0.00	0.00	0.00	0.00	0.00	0.00	0.00	0.00	0.00	0.00	0.00	0.00
G105.0	0.00	0.00	0.00	0.00	0.00	0.00	0.00	0.00	0.00	0.00	0.00	0.00	0.00
G106.0	0.00	0.00	0.00	0.00	0.00	0.00	0.00	0.00	0.00	0.00	0.00	0.00	0.00
G107.0	0.00	0.00	0.00	0.00	0.00	0.00	0.00	0.00	0.00	0.00	0.00	0.00	0.00
G108.0	0.00	0.00	0.00	0.00	0.00	0.00	0.00	0.00	0.00	0.00	0.00	0.00	0.00
G109.0	0.00	0.00	0.00	0.00	0.00	0.00	0.00	0.00	0.00	0.00	0.00	0.00	0.00
G110.0	0.00	0.00	0.00	0.00	0.00	0.00	0.00	0.00	0.00	0.00	0.00	0.00	0.00
G111.0	0.00	0.00	0.00	0.00	0.00	0.00	0.00	0.00	0.00	0.00	0.00	0.00	0.00
G112.0	0.00	0.00	0.00	0.00	0.00	0.00	0.00	0.00	0.00	0.00	0.00	0.00	0.00
G113.0	0.00	0.00	0.00	0.00	0.00	0.00	0.00	0.00	0.00	0.00	0.00	0.00	0.00
G114.0	0.00	0.00	0.00	0.00	0.00	0.00	0.00	0.00	0.00	0.00	0.00	0.00	0.00
G115.0	0.00	0.00	0.00	0.00	0.00	0.00	0.00	0.00	0.00	0.00	0.00	0.00	0.00
G116.0	0.00	0.00	0.00	0.00	0.00	0.00	0.00	0.00	0.00	0.00	0.00	0.00	0.00
G117.0	0.00	0.00	0.00	0.00	0.00	0.00	0.00	0.00	0.00	0.00	0.00	0.00	0.00
G118.0	0.00	0.00	0.00	0.00	0.00	0.00	0.00	0.00	0.00	0.00	0.00	0.00	0.00
G119.0	0.00	0.00	0.00	0.00	0.00	0.00	0.00	0.00	0.00	0.00	0.00	0.00	0.00
G120.0	0.00	0.00	0.00	0.00	0.00	0.00	0.00	0.00	0.00	0.00	0.00	0.00	0.00
G121.0	0.00	0.00	0.00	0.00	0.00	0.00	0.00	0.00	0.00	0.00	0.00	0.00	0.00
G122.0	0.00	0.00	0.00	0.00	0.00	0.00	0.00	0.00	0.00	0.00	0.00	0.00	0.00
G123.0	0.00	0.00	0.00	0.00	0.00	0.00	0.00	0.00	0.00	0.00	0.00	0.00	0.00
G124.0	0.00	0.00	0.00	0.00	0.00	0.00	0.00	0.00	0.00	0.00	0.00	0.00	0.00
G125.0	0.00	0.00	0.00	0.00	0.00	0.00	0.00	0.00	0.00	0.00	0.00	0.00	0.00
G126.0	0.00	0.00	0.00	0.00	0.00	0.00	0.00	0.00	0.00	0.00	0.00	0.00	0.00
G127.0	0.00	0.00	0.00	0.00	0.00	0.00	0.00	0.00	0.00	0.00	0.00	0.00	0.00
G128.0	0.00	0.00	0.00	0.00	0.00	0.00	0.00	0.00	0.00	0.00	0.00	0.00	0.00
G129.0	0.00	0.00	0.00	0.00	0.00	0.00	0.00	0.00	0.00	0.00	0.00	0.00	0.00
G130.0	0.00	0.00	0.00	0.00	0.00	0.00	0.00	0.00	0.00	0.00	0.00	0.00	0.00
G131.0	0.00	0.00	0.00	0.00	0.00	0.00	0.00	0.00	0.00	0.00	0.00	0.00	0.00
G132.0	0.00	0.00	0.00	0.00	0.00	0.00	0.00	0.00	0.00	0.00	0.00	0.00	0.00
G133.0	0.00	0.00	0.00	0.00	0.00	0.00	0.00	0.00	0.00	0.00	0.00	0.00	0.00
G134.0	0.00	0.00	0.00	0.00	0.00	0.00	0.00	0.00	0.00	0.00	0.00	0.00	0.00
G135.0	0.00	0.00	0.00	0.00	0.00	0.00	0.00	0.00	0.00	0.00	0.00	0.00	0.00
G136.0	0.00	0.00	0.00	0.00	0.00	0.00	0.00	0.00	0.00	0.00	0.00	0.00	0.00
G137.0	0.00	0.00	0.00	0.00	0.00	0.00	0.00	0.00	0.00	0.00	0.00	0.00	0.00
G138.0	0.00	0.00	0.00	0.00	0.00	0.00	0.00	0.00	0.00	0.00	0.00	0.00	0.00
G139.0	0.00	0.00	0.00	0.00	0.00	0.00	0.00	0.00	0.00	0.00	0.00	0.00	0.00
G140.0	0.00	0.00	0.00	0.00	0.00	0.00	0.00	0.00	0.00	0.00	0.00	0.00	0.00
G141.0	0.00	0.00	0.00	0.00	0.00	0.00	0.00	0.00	0.00	0.00	0.00	0.00	0.00
G142.0	0.00	0.00	0.00	0.00	0.00	0.00	0.00	0.00	0.00	0.00	0.00	0.00	0.00
G143.0	0.00	0.00	0.00	0.00	0.00	0.00	0.00	0.00	0.00	0.00	0.00	0.00	0.00
G144.0	0.00	0.00	0.00	0.00	0.00	0.00	0.00	0.00	0.00	0.00	0.00	0.00	0.00
G145.0	0.00	0.00	0.00	0.00	0.00	0.00	0.00	0.00	0.00	0.00	0.00	0.00	0.00



Apparecchio	Rilievo	Lampada
Codice ITALO 1 0F6 OP-DX 3.5-1M	Codice 18-009-8001	Codice L-IT1-0F6-3000-525-1M-70-25
Nome ITALO 1 0F6 OP-DX 3.5-1M	Nome ITALO 1 0F6 OP-DX 3.5-1M	Numero 1
Archivio Eulumdat	Data 23-07-2018	Posizione

Flusso Apparecchio	4800.00 lm	Potenza Apparecchio	39.00 W	Efficacia	123.08 lm/W	Rendimento	100.00%
Flusso Lampade	4800.00 lm	Valore Massimo	781.25 cd/klm	Posizione	C=65.00 G=56.00	CG	Asimmetrico

	Tabella Intensità Luminose - cd/klm						Tabella 8/18						
	C 65.00	C 70.00	C 75.00	C 80.00	C 85.00	C 90.00	C 95.00	C 100.00	C 105.00	C 110.00	C 115.00	C 120.00	C 125.00
G 73.0	188.54	180.03	160.49	148.14	138.30	133.26	122.09	119.40	112.53	109.57	102.01	96.06	86.53
G 74.0	144.17	135.45	118.39	107.18	99.27	95.00	85.35	84.66	81.30	80.20	76.03	73.76	66.31
G 75.0	106.54	98.22	83.71	73.82	67.63	64.04	55.80	56.51	55.93	55.94	54.49	54.76	49.19
G 76.0	77.06	70.08	58.07	49.76	45.02	42.02	35.24	36.68	37.60	37.93	38.23	39.62	35.61
G 77.0	54.95	49.96	40.34	33.74	30.20	27.70	22.41	24.01	25.37	25.40	26.61	28.00	25.20
G 78.0	38.82	36.06	28.66	23.77	21.20	19.14	15.28	16.66	17.74	17.15	18.64	19.34	17.47
G 79.0	27.32	26.63	21.20	17.87	16.06	14.39	11.81	12.76	13.21	11.96	13.32	13.07	11.87
G 80.0	19.07	19.88	16.11	14.05	12.83	11.50	9.96	10.46	10.31	8.59	9.65	8.64	7.89
G 81.0	12.90	14.33	11.88	10.66	9.90	8.87	8.09	8.25	7.78	6.04	6.80	5.52	5.06
G 82.0	8.33	9.67	8.22	7.50	7.07	6.32	6.02	5.96	5.47	4.03	4.55	3.44	3.13
G 83.0	5.11	5.91	5.17	4.70	4.50	3.98	3.97	3.79	3.44	2.51	2.82	2.15	1.89
G 84.0	2.93	3.04	2.78	2.40	2.35	2.02	2.14	1.91	1.80	1.41	1.57	1.41	1.16
G 85.0	1.53	1.05	1.09	0.73	0.77	0.58	0.74	0.52	0.61	0.67	0.72	0.99	0.73
G 86.0	1.23	0.84	0.87	0.59	0.61	0.46	0.59	0.41	0.51	0.53	0.59	0.67	0.44
G 87.0	0.92	0.63	0.65	0.44	0.46	0.35	0.44	0.31	0.41	0.40	0.45	0.42	0.24
G 88.0	0.61	0.42	0.43	0.29	0.31	0.23	0.30	0.21	0.30	0.27	0.31	0.22	0.11
G 89.0	0.31	0.21	0.22	0.15	0.15	0.12	0.15	0.10	0.20	0.13	0.18	0.09	0.04
G 90.0	0.00	0.00	0.00	0.00	0.00	0.00	0.00	0.00	0.00	0.00	0.00	0.00	0.00
G 91.0	0.00	0.00	0.00	0.00	0.00	0.00	0.00	0.00	0.00	0.00	0.00	0.00	0.00
G 92.0	0.00	0.00	0.00	0.00	0.00	0.00	0.00	0.00	0.00	0.00	0.00	0.00	0.00
G 93.0	0.00	0.00	0.00	0.00	0.00	0.00	0.00	0.00	0.00	0.00	0.00	0.00	0.00
G 94.0	0.00	0.00	0.00	0.00	0.00	0.00	0.00	0.00	0.00	0.00	0.00	0.00	0.00
G 95.0	0.00	0.00	0.00	0.00	0.00	0.00	0.00	0.00	0.00	0.00	0.00	0.00	0.00
G 96.0	0.00	0.00	0.00	0.00	0.00	0.00	0.00	0.00	0.00	0.00	0.00	0.00	0.00
G 97.0	0.00	0.00	0.00	0.00	0.00	0.00	0.00	0.00	0.00	0.00	0.00	0.00	0.00
G 98.0	0.00	0.00	0.00	0.00	0.00	0.00	0.00	0.00	0.00	0.00	0.00	0.00	0.00
G 99.0	0.00	0.00	0.00	0.00	0.00	0.00	0.00	0.00	0.00	0.00	0.00	0.00	0.00
G100.0	0.00	0.00	0.00	0.00	0.00	0.00	0.00	0.00	0.00	0.00	0.00	0.00	0.00
G101.0	0.00	0.00	0.00	0.00	0.00	0.00	0.00	0.00	0.00	0.00	0.00	0.00	0.00
G102.0	0.00	0.00	0.00	0.00	0.00	0.00	0.00	0.00	0.00	0.00	0.00	0.00	0.00
G103.0	0.00	0.00	0.00	0.00	0.00	0.00	0.00	0.00	0.00	0.00	0.00	0.00	0.00
G104.0	0.00	0.00	0.00	0.00	0.00	0.00	0.00	0.00	0.00	0.00	0.00	0.00	0.00
G105.0	0.00	0.00	0.00	0.00	0.00	0.00	0.00	0.00	0.00	0.00	0.00	0.00	0.00
G106.0	0.00	0.00	0.00	0.00	0.00	0.00	0.00	0.00	0.00	0.00	0.00	0.00	0.00
G107.0	0.00	0.00	0.00	0.00	0.00	0.00	0.00	0.00	0.00	0.00	0.00	0.00	0.00
G108.0	0.00	0.00	0.00	0.00	0.00	0.00	0.00	0.00	0.00	0.00	0.00	0.00	0.00
G109.0	0.00	0.00	0.00	0.00	0.00	0.00	0.00	0.00	0.00	0.00	0.00	0.00	0.00
G110.0	0.00	0.00	0.00	0.00	0.00	0.00	0.00	0.00	0.00	0.00	0.00	0.00	0.00
G111.0	0.00	0.00	0.00	0.00	0.00	0.00	0.00	0.00	0.00	0.00	0.00	0.00	0.00
G112.0	0.00	0.00	0.00	0.00	0.00	0.00	0.00	0.00	0.00	0.00	0.00	0.00	0.00
G113.0	0.00	0.00	0.00	0.00	0.00	0.00	0.00	0.00	0.00	0.00	0.00	0.00	0.00
G114.0	0.00	0.00	0.00	0.00	0.00	0.00	0.00	0.00	0.00	0.00	0.00	0.00	0.00
G115.0	0.00	0.00	0.00	0.00	0.00	0.00	0.00	0.00	0.00	0.00	0.00	0.00	0.00
G116.0	0.00	0.00	0.00	0.00	0.00	0.00	0.00	0.00	0.00	0.00	0.00	0.00	0.00
G117.0	0.00	0.00	0.00	0.00	0.00	0.00	0.00	0.00	0.00	0.00	0.00	0.00	0.00
G118.0	0.00	0.00	0.00	0.00	0.00	0.00	0.00	0.00	0.00	0.00	0.00	0.00	0.00
G119.0	0.00	0.00	0.00	0.00	0.00	0.00	0.00	0.00	0.00	0.00	0.00	0.00	0.00
G120.0	0.00	0.00	0.00	0.00	0.00	0.00	0.00	0.00	0.00	0.00	0.00	0.00	0.00
G121.0	0.00	0.00	0.00	0.00	0.00	0.00	0.00	0.00	0.00	0.00	0.00	0.00	0.00
G122.0	0.00	0.00	0.00	0.00	0.00	0.00	0.00	0.00	0.00	0.00	0.00	0.00	0.00
G123.0	0.00	0.00	0.00	0.00	0.00	0.00	0.00	0.00	0.00	0.00	0.00	0.00	0.00
G124.0	0.00	0.00	0.00	0.00	0.00	0.00	0.00	0.00	0.00	0.00	0.00	0.00	0.00
G125.0	0.00	0.00	0.00	0.00	0.00	0.00	0.00	0.00	0.00	0.00	0.00	0.00	0.00
G126.0	0.00	0.00	0.00	0.00	0.00	0.00	0.00	0.00	0.00	0.00	0.00	0.00	0.00
G127.0	0.00	0.00	0.00	0.00	0.00	0.00	0.00	0.00	0.00	0.00	0.00	0.00	0.00
G128.0	0.00	0.00	0.00	0.00	0.00	0.00	0.00	0.00	0.00	0.00	0.00	0.00	0.00
G129.0	0.00	0.00	0.00	0.00	0.00	0.00	0.00	0.00	0.00	0.00	0.00	0.00	0.00
G130.0	0.00	0.00	0.00	0.00	0.00	0.00	0.00	0.00	0.00	0.00	0.00	0.00	0.00
G131.0	0.00	0.00	0.00	0.00	0.00	0.00	0.00	0.00	0.00	0.00	0.00	0.00	0.00
G132.0	0.00	0.00	0.00	0.00	0.00	0.00	0.00	0.00	0.00	0.00	0.00	0.00	0.00
G133.0	0.00	0.00	0.00	0.00	0.00	0.00	0.00	0.00	0.00	0.00	0.00	0.00	0.00
G134.0	0.00	0.00	0.00	0.00	0.00	0.00	0.00	0.00	0.00	0.00	0.00	0.00	0.00
G135.0	0.00	0.00	0.00	0.00	0.00	0.00	0.00	0.00	0.00	0.00	0.00	0.00	0.00
G136.0	0.00	0.00	0.00	0.00	0.00	0.00	0.00	0.00	0.00	0.00	0.00	0.00	0.00
G137.0	0.00	0.00	0.00	0.00	0.00	0.00	0.00	0.00	0.00	0.00	0.00	0.00	0.00
G138.0	0.00	0.00	0.00	0.00	0.00	0.00	0.00	0.00	0.00	0.00	0.00	0.00	0.00
G139.0	0.00	0.00	0.00	0.00	0.00	0.00	0.00	0.00	0.00	0.00	0.00	0.00	0.00
G140.0	0.00	0.00	0.00	0.00	0.00	0.00	0.00	0.00	0.00	0.00	0.00	0.00	0.00
G141.0	0.00	0.00	0.00	0.00	0.00	0.00	0.00	0.00	0.00	0.00	0.00	0.00	0.00
G142.0	0.00	0.00	0.00	0.00	0.00	0.00	0.00	0.00	0.00	0.00	0.00	0.00	0.00
G143.0	0.00	0.00	0.00	0.00	0.00	0.00	0.00	0.00	0.00	0.00	0.00	0.00	0.00
G144.0	0.00	0.00	0.00	0.00	0.00	0.00	0.00	0.00	0.00	0.00	0.00	0.00	0.00
G145.0	0.00	0.00	0.00	0.00	0.00	0.00	0.00	0.00	0.00	0.00	0.00	0.00	0.00

Apparecchio		Rilievo		Lampada	
Codice	ITALO 1 0F6 OP-DX 3.5-1M	Codice	18-009-8001	Codice	L-IT1-0F6-3000-525-1M-70-25
Nome	ITALO 1 0F6 OP-DX 3.5-1M	Nome	ITALO 1 0F6 OP-DX 3.5-1M	Numero	1
Archivio	Eulumdat	Data	23-07-2018	Posizione	

Flusso Apparecchio	4800.00 lm	Potenza Apparecchio	39.00 W	Efficacia	123.08 lm/W	Rendimento	100.00%
Flusso Lampade	4800.00 lm	Valore Massimo	781.25 cd/klm	Posizione	C=65.00 G=56.00	CG	Asimmetrico

	Tabella Intensità Luminose - cd/klm						Tabella 9/18						
	C 130.00	C 135.00	C 140.00	C 145.00	C 150.00	C 155.00	C 160.00	C 165.00	C 170.00	C 175.00	C 180.00	C 185.00	C 190.00
G 73.0	70.44	56.40	46.63	34.38	20.72	15.20	10.04	6.88	5.46	5.16	4.55	3.10	3.37
G 74.0	54.30	43.53	36.58	28.65	17.41	13.34	9.15	6.59	5.39	4.54	4.11	3.03	3.04
G 75.0	40.79	32.89	28.17	23.57	14.65	11.72	8.36	6.32	5.26	4.05	3.74	2.99	2.74
G 76.0	30.04	24.52	21.41	18.90	12.13	10.09	7.46	5.87	4.88	3.65	3.39	2.87	2.51
G 77.0	21.75	18.14	16.11	14.67	9.84	8.45	6.48	5.25	4.28	3.32	3.07	2.65	2.32
G 78.0	15.51	13.38	12.03	10.96	7.79	6.90	5.48	4.53	3.59	3.05	2.76	2.39	2.17
G 79.0	10.92	9.90	8.94	7.86	6.04	5.48	4.52	3.80	2.89	2.81	2.49	2.09	2.04
G 80.0	7.58	7.32	6.60	5.45	4.61	4.29	3.65	3.11	2.30	2.59	2.23	1.80	1.90
G 81.0	5.13	5.33	4.79	3.78	3.52	3.36	2.95	2.54	1.89	2.37	2.01	1.54	1.73
G 82.0	3.38	3.81	3.42	2.71	2.72	2.67	2.37	2.07	1.64	2.15	1.81	1.31	1.55
G 83.0	2.19	2.68	2.40	2.08	2.15	2.15	1.91	1.69	1.47	1.92	1.61	1.11	1.35
G 84.0	1.42	1.86	1.66	1.73	1.72	1.74	1.53	1.37	1.35	1.66	1.40	0.92	1.14
G 85.0	0.92	1.27	1.12	1.46	1.37	1.39	1.21	1.10	1.20	1.39	1.17	0.74	0.92
G 86.0	0.57	0.84	0.72	1.17	1.04	1.04	0.92	0.85	0.99	1.10	0.91	0.58	0.69
G 87.0	0.34	0.53	0.42	0.83	0.73	0.71	0.65	0.62	0.72	0.79	0.64	0.43	0.47
G 88.0	0.19	0.33	0.21	0.51	0.46	0.42	0.43	0.43	0.45	0.51	0.38	0.29	0.28
G 89.0	0.11	0.20	0.08	0.22	0.23	0.17	0.25	0.27	0.21	0.27	0.16	0.18	0.12
G 90.0	0.00	0.00	0.00	0.00	0.00	0.00	0.00	0.00	0.00	0.00	0.00	0.00	0.00
G 91.0	0.00	0.00	0.00	0.00	0.00	0.00	0.00	0.00	0.00	0.00	0.00	0.00	0.00
G 92.0	0.00	0.00	0.00	0.00	0.00	0.00	0.00	0.00	0.00	0.00	0.00	0.00	0.00
G 93.0	0.00	0.00	0.00	0.00	0.00	0.00	0.00	0.00	0.00	0.00	0.00	0.00	0.00
G 94.0	0.00	0.00	0.00	0.00	0.00	0.00	0.00	0.00	0.00	0.00	0.00	0.00	0.00
G 95.0	0.00	0.00	0.00	0.00	0.00	0.00	0.00	0.00	0.00	0.00	0.00	0.00	0.00
G 96.0	0.00	0.00	0.00	0.00	0.00	0.00	0.00	0.00	0.00	0.00	0.00	0.00	0.00
G 97.0	0.00	0.00	0.00	0.00	0.00	0.00	0.00	0.00	0.00	0.00	0.00	0.00	0.00
G 98.0	0.00	0.00	0.00	0.00	0.00	0.00	0.00	0.00	0.00	0.00	0.00	0.00	0.00
G 99.0	0.00	0.00	0.00	0.00	0.00	0.00	0.00	0.00	0.00	0.00	0.00	0.00	0.00
G100.0	0.00	0.00	0.00	0.00	0.00	0.00	0.00	0.00	0.00	0.00	0.00	0.00	0.00
G101.0	0.00	0.00	0.00	0.00	0.00	0.00	0.00	0.00	0.00	0.00	0.00	0.00	0.00
G102.0	0.00	0.00	0.00	0.00	0.00	0.00	0.00	0.00	0.00	0.00	0.00	0.00	0.00
G103.0	0.00	0.00	0.00	0.00	0.00	0.00	0.00	0.00	0.00	0.00	0.00	0.00	0.00
G104.0	0.00	0.00	0.00	0.00	0.00	0.00	0.00	0.00	0.00	0.00	0.00	0.00	0.00
G105.0	0.00	0.00	0.00	0.00	0.00	0.00	0.00	0.00	0.00	0.00	0.00	0.00	0.00
G106.0	0.00	0.00	0.00	0.00	0.00	0.00	0.00	0.00	0.00	0.00	0.00	0.00	0.00
G107.0	0.00	0.00	0.00	0.00	0.00	0.00	0.00	0.00	0.00	0.00	0.00	0.00	0.00
G108.0	0.00	0.00	0.00	0.00	0.00	0.00	0.00	0.00	0.00	0.00	0.00	0.00	0.00
G109.0	0.00	0.00	0.00	0.00	0.00	0.00	0.00	0.00	0.00	0.00	0.00	0.00	0.00
G110.0	0.00	0.00	0.00	0.00	0.00	0.00	0.00	0.00	0.00	0.00	0.00	0.00	0.00
G111.0	0.00	0.00	0.00	0.00	0.00	0.00	0.00	0.00	0.00	0.00	0.00	0.00	0.00
G112.0	0.00	0.00	0.00	0.00	0.00	0.00	0.00	0.00	0.00	0.00	0.00	0.00	0.00
G113.0	0.00	0.00	0.00	0.00	0.00	0.00	0.00	0.00	0.00	0.00	0.00	0.00	0.00
G114.0	0.00	0.00	0.00	0.00	0.00	0.00	0.00	0.00	0.00	0.00	0.00	0.00	0.00
G115.0	0.00	0.00	0.00	0.00	0.00	0.00	0.00	0.00	0.00	0.00	0.00	0.00	0.00
G116.0	0.00	0.00	0.00	0.00	0.00	0.00	0.00	0.00	0.00	0.00	0.00	0.00	0.00
G117.0	0.00	0.00	0.00	0.00	0.00	0.00	0.00	0.00	0.00	0.00	0.00	0.00	0.00
G118.0	0.00	0.00	0.00	0.00	0.00	0.00	0.00	0.00	0.00	0.00	0.00	0.00	0.00
G119.0	0.00	0.00	0.00	0.00	0.00	0.00	0.00	0.00	0.00	0.00	0.00	0.00	0.00
G120.0	0.00	0.00	0.00	0.00	0.00	0.00	0.00	0.00	0.00	0.00	0.00	0.00	0.00
G121.0	0.00	0.00	0.00	0.00	0.00	0.00	0.00	0.00	0.00	0.00	0.00	0.00	0.00
G122.0	0.00	0.00	0.00	0.00	0.00	0.00	0.00	0.00	0.00	0.00	0.00	0.00	0.00
G123.0	0.00	0.00	0.00	0.00	0.00	0.00	0.00	0.00	0.00	0.00	0.00	0.00	0.00
G124.0	0.00	0.00	0.00	0.00	0.00	0.00	0.00	0.00	0.00	0.00	0.00	0.00	0.00
G125.0	0.00	0.00	0.00	0.00	0.00	0.00	0.00	0.00	0.00	0.00	0.00	0.00	0.00
G126.0	0.00	0.00	0.00	0.00	0.00	0.00	0.00	0.00	0.00	0.00	0.00	0.00	0.00
G127.0	0.00	0.00	0.00	0.00	0.00	0.00	0.00	0.00	0.00	0.00	0.00	0.00	0.00
G128.0	0.00	0.00	0.00	0.00	0.00	0.00	0.00	0.00	0.00	0.00	0.00	0.00	0.00
G129.0	0.00	0.00	0.00	0.00	0.00	0.00	0.00	0.00	0.00	0.00	0.00	0.00	0.00
G130.0	0.00	0.00	0.00	0.00	0.00	0.00	0.00	0.00	0.00	0.00	0.00	0.00	0.00
G131.0	0.00	0.00	0.00	0.00	0.00	0.00	0.00	0.00	0.00	0.00	0.00	0.00	0.00
G132.0	0.00	0.00	0.00	0.00	0.00	0.00	0.00	0.00	0.00	0.00	0.00	0.00	0.00
G133.0	0.00	0.00	0.00	0.00	0.00	0.00	0.00	0.00	0.00	0.00	0.00	0.00	0.00
G134.0	0.00	0.00	0.00	0.00	0.00	0.00	0.00	0.00	0.00	0.00	0.00	0.00	0.00
G135.0	0.00	0.00	0.00	0.00	0.00	0.00	0.00	0.00	0.00	0.00	0.00	0.00	0.00
G136.0	0.00	0.00	0.00	0.00	0.00	0.00	0.00	0.00	0.00	0.00	0.00	0.00	0.00
G137.0	0.00	0.00	0.00	0.00	0.00	0.00	0.00	0.00	0.00	0.00	0.00	0.00	0.00
G138.0	0.00	0.00	0.00	0.00	0.00	0.00	0.00	0.00	0.00	0.00	0.00	0.00	0.00
G139.0	0.00	0.00	0.00	0.00	0.00	0.00	0.00	0.00	0.00	0.00	0.00	0.00	0.00
G140.0	0.00	0.00	0.00	0.00	0.00	0.00	0.00	0.00	0.00	0.00	0.00	0.00	0.00
G141.0	0.00	0.00	0.00	0.00	0.00	0.00	0.00	0.00	0.00	0.00	0.00	0.00	0.00
G142.0	0.00	0.00	0.00	0.00	0.00	0.00	0.00	0.00	0.00	0.00	0.00	0.00	0.00
G143.0	0.00	0.00	0.00	0.00	0.00	0.00	0.00	0.00	0.00	0.00	0.00	0.00	0.00
G144.0	0.00	0.00	0.00	0.00	0.00	0.00	0.00	0.00	0.00	0.00	0.00	0.00	0.00
G145.0	0.00	0.00	0.00	0.00	0.00	0.00	0.00	0.00	0.00	0.00	0.00	0.00	0.00



Apparecchio		Rilievo		Lampada	
Codice	ITALO 1 0F6 OP-DX 3.5-1M	Codice	18-009-8001	Codice	L-IT1-0F6-3000-525-1M-70-25
Nome	ITALO 1 0F6 OP-DX 3.5-1M	Nome	ITALO 1 0F6 OP-DX 3.5-1M	Numero	1
Archivio	Eulumdat	Data	23-07-2018	Posizione	

Flusso Apparecchio	4800.00 lm	Potenza Apparecchio	39.00 W	Efficacia	123.08 lm/W	Rendimento	100.00%
Flusso Lampade	4800.00 lm	Valore Massimo	781.25 cd/klm	Posizione	C=65.00 G=56.00	CG	Asimmetrico

	Tabella Intensità Luminosa - cd/klm						Tabella 10/18						
	C 195.00	C 200.00	C 205.00	C 210.00	C 215.00	C 220.00	C 225.00	C 230.00	C 235.00	C 240.00	C 245.00	C 250.00	C 255.00
G 73.0	2.70	3.06	2.68	2.52	3.13	2.80	2.23	2.37	1.93	2.20	1.90	1.56	1.61
G 74.0	2.32	3.05	2.66	2.57	3.24	2.55	2.24	2.32	1.98	2.16	1.76	1.31	1.49
G 75.0	2.04	3.04	2.60	2.57	3.26	2.34	2.21	2.23	2.01	2.05	1.64	1.13	1.39
G 76.0	1.90	2.82	2.47	2.50	3.14	2.19	2.14	2.10	1.99	1.86	1.54	1.13	1.31
G 77.0	1.86	2.51	2.28	2.37	2.91	2.09	2.01	1.94	1.94	1.61	1.45	1.12	1.24
G 78.0	1.87	2.16	2.05	2.19	2.62	2.01	1.84	1.75	1.84	1.34	1.37	1.12	1.19
G 79.0	1.88	1.80	1.81	1.97	2.29	1.94	1.64	1.56	1.70	1.08	1.28	1.12	1.13
G 80.0	1.84	1.51	1.56	1.75	1.98	1.83	1.43	1.36	1.53	0.88	1.18	1.11	1.07
G 81.0	1.72	1.31	1.35	1.52	1.72	1.69	1.22	1.19	1.31	0.76	1.06	1.06	1.00
G 82.0	1.53	1.19	1.15	1.29	1.50	1.50	1.00	1.02	1.08	0.70	0.92	0.96	0.92
G 83.0	1.29	1.10	0.97	1.08	1.30	1.29	0.80	0.87	0.85	0.68	0.78	0.83	0.83
G 84.0	1.03	1.03	0.80	0.87	1.11	1.07	0.61	0.72	0.63	0.65	0.63	0.67	0.72
G 85.0	0.78	0.93	0.64	0.67	0.91	0.84	0.45	0.58	0.44	0.61	0.49	0.52	0.60
G 86.0	0.57	0.78	0.49	0.49	0.70	0.62	0.31	0.44	0.29	0.51	0.36	0.38	0.47
G 87.0	0.38	0.60	0.34	0.33	0.49	0.42	0.20	0.31	0.18	0.39	0.25	0.25	0.33
G 88.0	0.24	0.40	0.21	0.19	0.29	0.24	0.12	0.20	0.11	0.25	0.15	0.15	0.20
G 89.0	0.12	0.22	0.10	0.08	0.12	0.10	0.06	0.10	0.06	0.12	0.07	0.07	0.10
G 90.0	0.00	0.00	0.00	0.00	0.00	0.00	0.00	0.00	0.00	0.00	0.00	0.00	0.00
G 91.0	0.00	0.00	0.00	0.00	0.00	0.00	0.00	0.00	0.00	0.00	0.00	0.00	0.00
G 92.0	0.00	0.00	0.00	0.00	0.00	0.00	0.00	0.00	0.00	0.00	0.00	0.00	0.00
G 93.0	0.00	0.00	0.00	0.00	0.00	0.00	0.00	0.00	0.00	0.00	0.00	0.00	0.00
G 94.0	0.00	0.00	0.00	0.00	0.00	0.00	0.00	0.00	0.00	0.00	0.00	0.00	0.00
G 95.0	0.00	0.00	0.00	0.00	0.00	0.00	0.00	0.00	0.00	0.00	0.00	0.00	0.00
G 96.0	0.00	0.00	0.00	0.00	0.00	0.00	0.00	0.00	0.00	0.00	0.00	0.00	0.00
G 97.0	0.00	0.00	0.00	0.00	0.00	0.00	0.00	0.00	0.00	0.00	0.00	0.00	0.00
G 98.0	0.00	0.00	0.00	0.00	0.00	0.00	0.00	0.00	0.00	0.00	0.00	0.00	0.00
G 99.0	0.00	0.00	0.00	0.00	0.00	0.00	0.00	0.00	0.00	0.00	0.00	0.00	0.00
G100.0	0.00	0.00	0.00	0.00	0.00	0.00	0.00	0.00	0.00	0.00	0.00	0.00	0.00
G101.0	0.00	0.00	0.00	0.00	0.00	0.00	0.00	0.00	0.00	0.00	0.00	0.00	0.00
G102.0	0.00	0.00	0.00	0.00	0.00	0.00	0.00	0.00	0.00	0.00	0.00	0.00	0.00
G103.0	0.00	0.00	0.00	0.00	0.00	0.00	0.00	0.00	0.00	0.00	0.00	0.00	0.00
G104.0	0.00	0.00	0.00	0.00	0.00	0.00	0.00	0.00	0.00	0.00	0.00	0.00	0.00
G105.0	0.00	0.00	0.00	0.00	0.00	0.00	0.00	0.00	0.00	0.00	0.00	0.00	0.00
G106.0	0.00	0.00	0.00	0.00	0.00	0.00	0.00	0.00	0.00	0.00	0.00	0.00	0.00
G107.0	0.00	0.00	0.00	0.00	0.00	0.00	0.00	0.00	0.00	0.00	0.00	0.00	0.00
G108.0	0.00	0.00	0.00	0.00	0.00	0.00	0.00	0.00	0.00	0.00	0.00	0.00	0.00
G109.0	0.00	0.00	0.00	0.00	0.00	0.00	0.00	0.00	0.00	0.00	0.00	0.00	0.00
G110.0	0.00	0.00	0.00	0.00	0.00	0.00	0.00	0.00	0.00	0.00	0.00	0.00	0.00
G111.0	0.00	0.00	0.00	0.00	0.00	0.00	0.00	0.00	0.00	0.00	0.00	0.00	0.00
G112.0	0.00	0.00	0.00	0.00	0.00	0.00	0.00	0.00	0.00	0.00	0.00	0.00	0.00
G113.0	0.00	0.00	0.00	0.00	0.00	0.00	0.00	0.00	0.00	0.00	0.00	0.00	0.00
G114.0	0.00	0.00	0.00	0.00	0.00	0.00	0.00	0.00	0.00	0.00	0.00	0.00	0.00
G115.0	0.00	0.00	0.00	0.00	0.00	0.00	0.00	0.00	0.00	0.00	0.00	0.00	0.00
G116.0	0.00	0.00	0.00	0.00	0.00	0.00	0.00	0.00	0.00	0.00	0.00	0.00	0.00
G117.0	0.00	0.00	0.00	0.00	0.00	0.00	0.00	0.00	0.00	0.00	0.00	0.00	0.00
G118.0	0.00	0.00	0.00	0.00	0.00	0.00	0.00	0.00	0.00	0.00	0.00	0.00	0.00
G119.0	0.00	0.00	0.00	0.00	0.00	0.00	0.00	0.00	0.00	0.00	0.00	0.00	0.00
G120.0	0.00	0.00	0.00	0.00	0.00	0.00	0.00	0.00	0.00	0.00	0.00	0.00	0.00
G121.0	0.00	0.00	0.00	0.00	0.00	0.00	0.00	0.00	0.00	0.00	0.00	0.00	0.00
G122.0	0.00	0.00	0.00	0.00	0.00	0.00	0.00	0.00	0.00	0.00	0.00	0.00	0.00
G123.0	0.00	0.00	0.00	0.00	0.00	0.00	0.00	0.00	0.00	0.00	0.00	0.00	0.00
G124.0	0.00	0.00	0.00	0.00	0.00	0.00	0.00	0.00	0.00	0.00	0.00	0.00	0.00
G125.0	0.00	0.00	0.00	0.00	0.00	0.00	0.00	0.00	0.00	0.00	0.00	0.00	0.00
G126.0	0.00	0.00	0.00	0.00	0.00	0.00	0.00	0.00	0.00	0.00	0.00	0.00	0.00
G127.0	0.00	0.00	0.00	0.00	0.00	0.00	0.00	0.00	0.00	0.00	0.00	0.00	0.00
G128.0	0.00	0.00	0.00	0.00	0.00	0.00	0.00	0.00	0.00	0.00	0.00	0.00	0.00
G129.0	0.00	0.00	0.00	0.00	0.00	0.00	0.00	0.00	0.00	0.00	0.00	0.00	0.00
G130.0	0.00	0.00	0.00	0.00	0.00	0.00	0.00	0.00	0.00	0.00	0.00	0.00	0.00
G131.0	0.00	0.00	0.00	0.00	0.00	0.00	0.00	0.00	0.00	0.00	0.00	0.00	0.00
G132.0	0.00	0.00	0.00	0.00	0.00	0.00	0.00	0.00	0.00	0.00	0.00	0.00	0.00
G133.0	0.00	0.00	0.00	0.00	0.00	0.00	0.00	0.00	0.00	0.00	0.00	0.00	0.00
G134.0	0.00	0.00	0.00	0.00	0.00	0.00	0.00	0.00	0.00	0.00	0.00	0.00	0.00
G135.0	0.00	0.00	0.00	0.00	0.00	0.00	0.00	0.00	0.00	0.00	0.00	0.00	0.00
G136.0	0.00	0.00	0.00	0.00	0.00	0.00	0.00	0.00	0.00	0.00	0.00	0.00	0.00
G137.0	0.00	0.00	0.00	0.00	0.00	0.00	0.00	0.00	0.00	0.00	0.00	0.00	0.00
G138.0	0.00	0.00	0.00	0.00	0.00	0.00	0.00	0.00	0.00	0.00	0.00	0.00	0.00
G139.0	0.00	0.00	0.00	0.00	0.00	0.00	0.00	0.00	0.00	0.00	0.00	0.00	0.00
G140.0	0.00	0.00	0.00	0.00	0.00	0.00	0.00	0.00	0.00	0.00	0.00	0.00	0.00
G141.0	0.00	0.00	0.00	0.00	0.00	0.00	0.00	0.00	0.00	0.00	0.00	0.00	0.00
G142.0	0.00	0.00	0.00	0.00	0.00	0.00	0.00	0.00	0.00	0.00	0.00	0.00	0.00
G143.0	0.00	0.00	0.00	0.00	0.00	0.00	0.00	0.00	0.00	0.00	0.00	0.00	0.00
G144.0	0.00	0.00	0.00	0.00	0.00	0.00	0.00	0.00	0.00	0.00	0.00	0.00	0.00
G145.0	0.00	0.00	0.00	0.00	0.00	0.00	0.00	0.00	0.00	0.00	0.00	0.00	0.00



Apparecchio	Rilievo	Lampada
Codice ITALO 1 0F6 OP-DX 3.5-1M	Codice 18-009-8001	Codice L-IT1-0F6-3000-525-1M-70-25
Nome ITALO 1 0F6 OP-DX 3.5-1M	Nome ITALO 1 0F6 OP-DX 3.5-1M	Numero 1
Archivio Eulumdat	Data 23-07-2018	Posizione

Flusso Apparecchio	4800.00 lm	Potenza Apparecchio	39.00 W	Efficacia	123.08 lm/W	Rendimento	100.00%
Flusso Lampade	4800.00 lm	Valore Massimo	781.25 cd/klm	Posizione	C=65.00 G=56.00	CG	Asimmetrico

Tabella Intensità Luminosa - cd/klm Tabella 11/18

	C 260.00	C 265.00	C 270.00	C 275.00	C 280.00	C 285.00	C 290.00	C 295.00	C 300.00	C 305.00	C 310.00	C 315.00	C 320.00
G 73.0	1.42	1.62	1.38	1.24	1.54	1.74	1.44	1.72	1.57	1.50	2.01	1.48	1.80
G 74.0	1.32	1.59	1.31	1.14	1.52	1.72	1.34	1.66	1.38	1.59	2.05	1.37	1.65
G 75.0	1.24	1.53	1.23	1.09	1.51	1.68	1.25	1.60	1.22	1.63	2.02	1.28	1.49
G 76.0	1.20	1.41	1.13	1.10	1.41	1.59	1.17	1.53	1.11	1.58	1.88	1.23	1.34
G 77.0	1.17	1.26	1.03	1.15	1.27	1.45	1.09	1.44	1.05	1.46	1.67	1.21	1.19
G 78.0	1.15	1.09	0.93	1.21	1.11	1.30	1.02	1.35	1.01	1.31	1.40	1.20	1.05
G 79.0	1.12	0.92	0.83	1.24	0.95	1.12	0.95	1.25	0.97	1.15	1.13	1.18	0.92
G 80.0	1.09	0.77	0.74	1.22	0.79	0.95	0.87	1.14	0.90	1.00	0.89	1.13	0.81
G 81.0	1.02	0.64	0.66	1.11	0.66	0.78	0.78	1.03	0.80	0.90	0.70	1.04	0.71
G 82.0	0.93	0.54	0.59	0.95	0.55	0.62	0.68	0.91	0.68	0.83	0.56	0.93	0.63
G 83.0	0.83	0.46	0.53	0.75	0.46	0.47	0.58	0.79	0.54	0.77	0.46	0.79	0.55
G 84.0	0.70	0.38	0.47	0.55	0.39	0.34	0.47	0.67	0.40	0.70	0.38	0.64	0.48
G 85.0	0.57	0.31	0.39	0.38	0.32	0.24	0.37	0.55	0.28	0.62	0.31	0.50	0.40
G 86.0	0.43	0.24	0.31	0.24	0.25	0.15	0.27	0.43	0.18	0.50	0.24	0.37	0.31
G 87.0	0.30	0.17	0.22	0.15	0.19	0.09	0.18	0.31	0.11	0.36	0.16	0.26	0.22
G 88.0	0.18	0.10	0.13	0.10	0.14	0.05	0.10	0.21	0.05	0.22	0.10	0.17	0.13
G 89.0	0.07	0.04	0.06	0.06	0.09	0.02	0.04	0.13	0.02	0.09	0.04	0.10	0.05
G 90.0	0.00	0.00	0.00	0.00	0.00	0.00	0.00	0.00	0.00	0.00	0.00	0.00	0.00
G 91.0	0.00	0.00	0.00	0.00	0.00	0.00	0.00	0.00	0.00	0.00	0.00	0.00	0.00
G 92.0	0.00	0.00	0.00	0.00	0.00	0.00	0.00	0.00	0.00	0.00	0.00	0.00	0.00
G 93.0	0.00	0.00	0.00	0.00	0.00	0.00	0.00	0.00	0.00	0.00	0.00	0.00	0.00
G 94.0	0.00	0.00	0.00	0.00	0.00	0.00	0.00	0.00	0.00	0.00	0.00	0.00	0.00
G 95.0	0.00	0.00	0.00	0.00	0.00	0.00	0.00	0.00	0.00	0.00	0.00	0.00	0.00
G 96.0	0.00	0.00	0.00	0.00	0.00	0.00	0.00	0.00	0.00	0.00	0.00	0.00	0.00
G 97.0	0.00	0.00	0.00	0.00	0.00	0.00	0.00	0.00	0.00	0.00	0.00	0.00	0.00
G 98.0	0.00	0.00	0.00	0.00	0.00	0.00	0.00	0.00	0.00	0.00	0.00	0.00	0.00
G 99.0	0.00	0.00	0.00	0.00	0.00	0.00	0.00	0.00	0.00	0.00	0.00	0.00	0.00
G100.0	0.00	0.00	0.00	0.00	0.00	0.00	0.00	0.00	0.00	0.00	0.00	0.00	0.00
G101.0	0.00	0.00	0.00	0.00	0.00	0.00	0.00	0.00	0.00	0.00	0.00	0.00	0.00
G102.0	0.00	0.00	0.00	0.00	0.00	0.00	0.00	0.00	0.00	0.00	0.00	0.00	0.00
G103.0	0.00	0.00	0.00	0.00	0.00	0.00	0.00	0.00	0.00	0.00	0.00	0.00	0.00
G104.0	0.00	0.00	0.00	0.00	0.00	0.00	0.00	0.00	0.00	0.00	0.00	0.00	0.00
G105.0	0.00	0.00	0.00	0.00	0.00	0.00	0.00	0.00	0.00	0.00	0.00	0.00	0.00
G106.0	0.00	0.00	0.00	0.00	0.00	0.00	0.00	0.00	0.00	0.00	0.00	0.00	0.00
G107.0	0.00	0.00	0.00	0.00	0.00	0.00	0.00	0.00	0.00	0.00	0.00	0.00	0.00
G108.0	0.00	0.00	0.00	0.00	0.00	0.00	0.00	0.00	0.00	0.00	0.00	0.00	0.00
G109.0	0.00	0.00	0.00	0.00	0.00	0.00	0.00	0.00	0.00	0.00	0.00	0.00	0.00
G110.0	0.00	0.00	0.00	0.00	0.00	0.00	0.00	0.00	0.00	0.00	0.00	0.00	0.00
G111.0	0.00	0.00	0.00	0.00	0.00	0.00	0.00	0.00	0.00	0.00	0.00	0.00	0.00
G112.0	0.00	0.00	0.00	0.00	0.00	0.00	0.00	0.00	0.00	0.00	0.00	0.00	0.00
G113.0	0.00	0.00	0.00	0.00	0.00	0.00	0.00	0.00	0.00	0.00	0.00	0.00	0.00
G114.0	0.00	0.00	0.00	0.00	0.00	0.00	0.00	0.00	0.00	0.00	0.00	0.00	0.00
G115.0	0.00	0.00	0.00	0.00	0.00	0.00	0.00	0.00	0.00	0.00	0.00	0.00	0.00
G116.0	0.00	0.00	0.00	0.00	0.00	0.00	0.00	0.00	0.00	0.00	0.00	0.00	0.00
G117.0	0.00	0.00	0.00	0.00	0.00	0.00	0.00	0.00	0.00	0.00	0.00	0.00	0.00
G118.0	0.00	0.00	0.00	0.00	0.00	0.00	0.00	0.00	0.00	0.00	0.00	0.00	0.00
G119.0	0.00	0.00	0.00	0.00	0.00	0.00	0.00	0.00	0.00	0.00	0.00	0.00	0.00
G120.0	0.00	0.00	0.00	0.00	0.00	0.00	0.00	0.00	0.00	0.00	0.00	0.00	0.00
G121.0	0.00	0.00	0.00	0.00	0.00	0.00	0.00	0.00	0.00	0.00	0.00	0.00	0.00
G122.0	0.00	0.00	0.00	0.00	0.00	0.00	0.00	0.00	0.00	0.00	0.00	0.00	0.00
G123.0	0.00	0.00	0.00	0.00	0.00	0.00	0.00	0.00	0.00	0.00	0.00	0.00	0.00
G124.0	0.00	0.00	0.00	0.00	0.00	0.00	0.00	0.00	0.00	0.00	0.00	0.00	0.00
G125.0	0.00	0.00	0.00	0.00	0.00	0.00	0.00	0.00	0.00	0.00	0.00	0.00	0.00
G126.0	0.00	0.00	0.00	0.00	0.00	0.00	0.00	0.00	0.00	0.00	0.00	0.00	0.00
G127.0	0.00	0.00	0.00	0.00	0.00	0.00	0.00	0.00	0.00	0.00	0.00	0.00	0.00
G128.0	0.00	0.00	0.00	0.00	0.00	0.00	0.00	0.00	0.00	0.00	0.00	0.00	0.00
G129.0	0.00	0.00	0.00	0.00	0.00	0.00	0.00	0.00	0.00	0.00	0.00	0.00	0.00
G130.0	0.00	0.00	0.00	0.00	0.00	0.00	0.00	0.00	0.00	0.00	0.00	0.00	0.00
G131.0	0.00	0.00	0.00	0.00	0.00	0.00	0.00	0.00	0.00	0.00	0.00	0.00	0.00
G132.0	0.00	0.00	0.00	0.00	0.00	0.00	0.00	0.00	0.00	0.00	0.00	0.00	0.00
G133.0	0.00	0.00	0.00	0.00	0.00	0.00	0.00	0.00	0.00	0.00	0.00	0.00	0.00
G134.0	0.00	0.00	0.00	0.00	0.00	0.00	0.00	0.00	0.00	0.00	0.00	0.00	0.00
G135.0	0.00	0.00	0.00	0.00	0.00	0.00	0.00	0.00	0.00	0.00	0.00	0.00	0.00
G136.0	0.00	0.00	0.00	0.00	0.00	0.00	0.00	0.00	0.00	0.00	0.00	0.00	0.00
G137.0	0.00	0.00	0.00	0.00	0.00	0.00	0.00	0.00	0.00	0.00	0.00	0.00	0.00
G138.0	0.00	0.00	0.00	0.00	0.00	0.00	0.00	0.00	0.00	0.00	0.00	0.00	0.00
G139.0	0.00	0.00	0.00	0.00	0.00	0.00	0.00	0.00	0.00	0.00	0.00	0.00	0.00
G140.0	0.00	0.00	0.00	0.00	0.00	0.00	0.00	0.00	0.00	0.00	0.00	0.00	0.00
G141.0	0.00	0.00	0.00	0.00	0.00	0.00	0.00	0.00	0.00	0.00	0.00	0.00	0.00
G142.0	0.00	0.00	0.00	0.00	0.00	0.00	0.00	0.00	0.00	0.00	0.00	0.00	0.00
G143.0	0.00	0.00	0.00	0.00	0.00	0.00	0.00	0.00	0.00	0.00	0.00	0.00	0.00
G144.0	0.00	0.00	0.00	0.00	0.00	0.00	0.00	0.00	0.00	0.00	0.00	0.00	0.00
G145.0	0.00	0.00	0.00	0.00	0.00	0.00	0.00	0.00	0.00	0.00	0.00	0.00	0.00



Apparecchio		Rilievo		Lampada	
Codice	ITALO 1 0F6 OP-DX 3.5-1M	Codice	18-009-8001	Codice	L-IT1-0F6-3000-525-1M-70-25
Nome	ITALO 1 0F6 OP-DX 3.5-1M	Nome	ITALO 1 0F6 OP-DX 3.5-1M	Numero	1
Archivio	Eulumdat	Data	23-07-2018	Posizione	

Flusso Apparecchio	4800.00 lm	Potenza Apparecchio	39.00 W	Efficacia	123.08 lm/W	Rendimento	100.00%
Flusso Lampade	4800.00 lm	Valore Massimo	781.25 cd/klm	Posizione	C=65.00 G=56.00	CG	Asimmetrico

	Tabella Intensità Luminose - cd/klm				Tabella 12/18			
	C 325.00	C 330.00	C 335.00	C 340.00	C 345.00	C 350.00	C 355.00	
G 73.0	1.70	1.75	1.50	2.46	2.30	3.37	8.19	
G 74.0	1.62	1.48	1.44	2.28	2.00	2.92	5.88	
G 75.0	1.51	1.26	1.38	2.09	1.77	2.58	4.38	
G 76.0	1.39	1.13	1.32	1.90	1.59	2.28	3.40	
G 77.0	1.24	1.06	1.25	1.71	1.45	1.99	2.78	
G 78.0	1.08	1.04	1.18	1.52	1.33	1.73	2.40	
G 79.0	0.92	1.03	1.09	1.33	1.21	1.47	2.16	
G 80.0	0.78	1.01	0.99	1.14	1.08	1.23	1.95	
G 81.0	0.66	0.95	0.89	0.96	0.93	0.99	1.66	
G 82.0	0.56	0.86	0.78	0.78	0.76	0.77	1.33	
G 83.0	0.47	0.75	0.66	0.62	0.59	0.56	0.98	
G 84.0	0.40	0.62	0.54	0.47	0.43	0.39	0.65	
G 85.0	0.32	0.50	0.43	0.35	0.29	0.24	0.39	
G 86.0	0.24	0.38	0.32	0.24	0.19	0.14	0.32	
G 87.0	0.17	0.26	0.21	0.15	0.11	0.07	0.26	
G 88.0	0.10	0.16	0.12	0.08	0.05	0.03	0.19	
G 89.0	0.04	0.08	0.05	0.03	0.02	0.01	0.13	
G 90.0	0.00	0.00	0.00	0.00	0.00	0.00	0.00	
G 91.0	0.00	0.00	0.00	0.00	0.00	0.00	0.00	
G 92.0	0.00	0.00	0.00	0.00	0.00	0.00	0.00	
G 93.0	0.00	0.00	0.00	0.00	0.00	0.00	0.00	
G 94.0	0.00	0.00	0.00	0.00	0.00	0.00	0.00	
G 95.0	0.00	0.00	0.00	0.00	0.00	0.00	0.00	
G 96.0	0.00	0.00	0.00	0.00	0.00	0.00	0.00	
G 97.0	0.00	0.00	0.00	0.00	0.00	0.00	0.00	
G 98.0	0.00	0.00	0.00	0.00	0.00	0.00	0.00	
G 99.0	0.00	0.00	0.00	0.00	0.00	0.00	0.00	
G100.0	0.00	0.00	0.00	0.00	0.00	0.00	0.00	
G101.0	0.00	0.00	0.00	0.00	0.00	0.00	0.00	
G102.0	0.00	0.00	0.00	0.00	0.00	0.00	0.00	
G103.0	0.00	0.00	0.00	0.00	0.00	0.00	0.00	
G104.0	0.00	0.00	0.00	0.00	0.00	0.00	0.00	
G105.0	0.00	0.00	0.00	0.00	0.00	0.00	0.00	
G106.0	0.00	0.00	0.00	0.00	0.00	0.00	0.00	
G107.0	0.00	0.00	0.00	0.00	0.00	0.00	0.00	
G108.0	0.00	0.00	0.00	0.00	0.00	0.00	0.00	
G109.0	0.00	0.00	0.00	0.00	0.00	0.00	0.00	
G110.0	0.00	0.00	0.00	0.00	0.00	0.00	0.00	
G111.0	0.00	0.00	0.00	0.00	0.00	0.00	0.00	
G112.0	0.00	0.00	0.00	0.00	0.00	0.00	0.00	
G113.0	0.00	0.00	0.00	0.00	0.00	0.00	0.00	
G114.0	0.00	0.00	0.00	0.00	0.00	0.00	0.00	
G115.0	0.00	0.00	0.00	0.00	0.00	0.00	0.00	
G116.0	0.00	0.00	0.00	0.00	0.00	0.00	0.00	
G117.0	0.00	0.00	0.00	0.00	0.00	0.00	0.00	
G118.0	0.00	0.00	0.00	0.00	0.00	0.00	0.00	
G119.0	0.00	0.00	0.00	0.00	0.00	0.00	0.00	
G120.0	0.00	0.00	0.00	0.00	0.00	0.00	0.00	
G121.0	0.00	0.00	0.00	0.00	0.00	0.00	0.00	
G122.0	0.00	0.00	0.00	0.00	0.00	0.00	0.00	
G123.0	0.00	0.00	0.00	0.00	0.00	0.00	0.00	
G124.0	0.00	0.00	0.00	0.00	0.00	0.00	0.00	
G125.0	0.00	0.00	0.00	0.00	0.00	0.00	0.00	
G126.0	0.00	0.00	0.00	0.00	0.00	0.00	0.00	
G127.0	0.00	0.00	0.00	0.00	0.00	0.00	0.00	
G128.0	0.00	0.00	0.00	0.00	0.00	0.00	0.00	
G129.0	0.00	0.00	0.00	0.00	0.00	0.00	0.00	
G130.0	0.00	0.00	0.00	0.00	0.00	0.00	0.00	
G131.0	0.00	0.00	0.00	0.00	0.00	0.00	0.00	
G132.0	0.00	0.00	0.00	0.00	0.00	0.00	0.00	
G133.0	0.00	0.00	0.00	0.00	0.00	0.00	0.00	
G134.0	0.00	0.00	0.00	0.00	0.00	0.00	0.00	
G135.0	0.00	0.00	0.00	0.00	0.00	0.00	0.00	
G136.0	0.00	0.00	0.00	0.00	0.00	0.00	0.00	
G137.0	0.00	0.00	0.00	0.00	0.00	0.00	0.00	
G138.0	0.00	0.00	0.00	0.00	0.00	0.00	0.00	
G139.0	0.00	0.00	0.00	0.00	0.00	0.00	0.00	
G140.0	0.00	0.00	0.00	0.00	0.00	0.00	0.00	
G141.0	0.00	0.00	0.00	0.00	0.00	0.00	0.00	
G142.0	0.00	0.00	0.00	0.00	0.00	0.00	0.00	
G143.0	0.00	0.00	0.00	0.00	0.00	0.00	0.00	
G144.0	0.00	0.00	0.00	0.00	0.00	0.00	0.00	
G145.0	0.00	0.00	0.00	0.00	0.00	0.00	0.00	



Apparecchio	Rilievo	Lampada
Codice ITALO 1 0F6 OP-DX 3.5-1M	Codice 18-009-8001	Codice L-IT1-0F6-3000-525-1M-70-25
Nome ITALO 1 0F6 OP-DX 3.5-1M	Nome ITALO 1 0F6 OP-DX 3.5-1M	Numero 1
Archivio Eulumdat	Data 23-07-2018	Posizione

Flusso Apparecchio	4800.00 lm	Potenza Apparecchio	39.00 W	Efficacia	123.08 lm/W	Rendimento	100.00%
Flusso Lampade	4800.00 lm	Valore Massimo	781.25 cd/klm	Posizione	C=65.00 G=56.00	CG	Asimmetrico

Tabella Intensità Luminose - cd/klm Tabella 13/18

	C 0.00	C 5.00	C 10.00	C 15.00	C 20.00	C 25.00	C 30.00	C 35.00	C 40.00	C 45.00	C 50.00	C 55.00	C 60.00
G146.0	0.00	0.00	0.00	0.00	0.00	0.00	0.00	0.00	0.00	0.00	0.00	0.00	0.00
G147.0	0.00	0.00	0.00	0.00	0.00	0.00	0.00	0.00	0.00	0.00	0.00	0.00	0.00
G148.0	0.00	0.00	0.00	0.00	0.00	0.00	0.00	0.00	0.00	0.00	0.00	0.00	0.00
G149.0	0.00	0.00	0.00	0.00	0.00	0.00	0.00	0.00	0.00	0.00	0.00	0.00	0.00
G150.0	0.00	0.00	0.00	0.00	0.00	0.00	0.00	0.00	0.00	0.00	0.00	0.00	0.00
G151.0	0.00	0.00	0.00	0.00	0.00	0.00	0.00	0.00	0.00	0.00	0.00	0.00	0.00
G152.0	0.00	0.00	0.00	0.00	0.00	0.00	0.00	0.00	0.00	0.00	0.00	0.00	0.00
G153.0	0.00	0.00	0.00	0.00	0.00	0.00	0.00	0.00	0.00	0.00	0.00	0.00	0.00
G154.0	0.00	0.00	0.00	0.00	0.00	0.00	0.00	0.00	0.00	0.00	0.00	0.00	0.00
G155.0	0.00	0.00	0.00	0.00	0.00	0.00	0.00	0.00	0.00	0.00	0.00	0.00	0.00
G156.0	0.00	0.00	0.00	0.00	0.00	0.00	0.00	0.00	0.00	0.00	0.00	0.00	0.00
G157.0	0.00	0.00	0.00	0.00	0.00	0.00	0.00	0.00	0.00	0.00	0.00	0.00	0.00
G158.0	0.00	0.00	0.00	0.00	0.00	0.00	0.00	0.00	0.00	0.00	0.00	0.00	0.00
G159.0	0.00	0.00	0.00	0.00	0.00	0.00	0.00	0.00	0.00	0.00	0.00	0.00	0.00
G160.0	0.00	0.00	0.00	0.00	0.00	0.00	0.00	0.00	0.00	0.00	0.00	0.00	0.00
G161.0	0.00	0.00	0.00	0.00	0.00	0.00	0.00	0.00	0.00	0.00	0.00	0.00	0.00
G162.0	0.00	0.00	0.00	0.00	0.00	0.00	0.00	0.00	0.00	0.00	0.00	0.00	0.00
G163.0	0.00	0.00	0.00	0.00	0.00	0.00	0.00	0.00	0.00	0.00	0.00	0.00	0.00
G164.0	0.00	0.00	0.00	0.00	0.00	0.00	0.00	0.00	0.00	0.00	0.00	0.00	0.00
G165.0	0.00	0.00	0.00	0.00	0.00	0.00	0.00	0.00	0.00	0.00	0.00	0.00	0.00
G166.0	0.00	0.00	0.00	0.00	0.00	0.00	0.00	0.00	0.00	0.00	0.00	0.00	0.00
G167.0	0.00	0.00	0.00	0.00	0.00	0.00	0.00	0.00	0.00	0.00	0.00	0.00	0.00
G168.0	0.00	0.00	0.00	0.00	0.00	0.00	0.00	0.00	0.00	0.00	0.00	0.00	0.00
G169.0	0.00	0.00	0.00	0.00	0.00	0.00	0.00	0.00	0.00	0.00	0.00	0.00	0.00
G170.0	0.00	0.00	0.00	0.00	0.00	0.00	0.00	0.00	0.00	0.00	0.00	0.00	0.00
G171.0	0.00	0.00	0.00	0.00	0.00	0.00	0.00	0.00	0.00	0.00	0.00	0.00	0.00
G172.0	0.00	0.00	0.00	0.00	0.00	0.00	0.00	0.00	0.00	0.00	0.00	0.00	0.00
G173.0	0.00	0.00	0.00	0.00	0.00	0.00	0.00	0.00	0.00	0.00	0.00	0.00	0.00
G174.0	0.00	0.00	0.00	0.00	0.00	0.00	0.00	0.00	0.00	0.00	0.00	0.00	0.00
G175.0	0.00	0.00	0.00	0.00	0.00	0.00	0.00	0.00	0.00	0.00	0.00	0.00	0.00
G176.0	0.00	0.00	0.00	0.00	0.00	0.00	0.00	0.00	0.00	0.00	0.00	0.00	0.00
G177.0	0.00	0.00	0.00	0.00	0.00	0.00	0.00	0.00	0.00	0.00	0.00	0.00	0.00
G178.0	0.00	0.00	0.00	0.00	0.00	0.00	0.00	0.00	0.00	0.00	0.00	0.00	0.00
G179.0	0.00	0.00	0.00	0.00	0.00	0.00	0.00	0.00	0.00	0.00	0.00	0.00	0.00
G180.0	0.00	0.00	0.00	0.00	0.00	0.00	0.00	0.00	0.00	0.00	0.00	0.00	0.00



Apparecchio	Rilievo	Lampada
Codice ITALO 1 0F6 OP-DX 3.5-1M	Codice 18-009-8001	Codice L-IT1-0F6-3000-525-1M-70-25
Nome ITALO 1 0F6 OP-DX 3.5-1M	Nome ITALO 1 0F6 OP-DX 3.5-1M	Numero 1
Archivio Eulumdat	Data 23-07-2018	Posizione

Flusso Apparecchio	4800.00 lm	Potenza Apparecchio	39.00 W	Efficacia	123.08 lm/W	Rendimento	100.00%
Flusso Lampade	4800.00 lm	Valore Massimo	781.25 cd/klm	Posizione	C=65.00 G=56.00	CG	Asimmetrico

Tabella Intensità Luminose - cd/klm Tabella 14/18

	C 65.00	C 70.00	C 75.00	C 80.00	C 85.00	C 90.00	C 95.00	C 100.00	C 105.00	C 110.00	C 115.00	C 120.00	C 125.00
G146.0	0.00	0.00	0.00	0.00	0.00	0.00	0.00	0.00	0.00	0.00	0.00	0.00	0.00
G147.0	0.00	0.00	0.00	0.00	0.00	0.00	0.00	0.00	0.00	0.00	0.00	0.00	0.00
G148.0	0.00	0.00	0.00	0.00	0.00	0.00	0.00	0.00	0.00	0.00	0.00	0.00	0.00
G149.0	0.00	0.00	0.00	0.00	0.00	0.00	0.00	0.00	0.00	0.00	0.00	0.00	0.00
G150.0	0.00	0.00	0.00	0.00	0.00	0.00	0.00	0.00	0.00	0.00	0.00	0.00	0.00
G151.0	0.00	0.00	0.00	0.00	0.00	0.00	0.00	0.00	0.00	0.00	0.00	0.00	0.00
G152.0	0.00	0.00	0.00	0.00	0.00	0.00	0.00	0.00	0.00	0.00	0.00	0.00	0.00
G153.0	0.00	0.00	0.00	0.00	0.00	0.00	0.00	0.00	0.00	0.00	0.00	0.00	0.00
G154.0	0.00	0.00	0.00	0.00	0.00	0.00	0.00	0.00	0.00	0.00	0.00	0.00	0.00
G155.0	0.00	0.00	0.00	0.00	0.00	0.00	0.00	0.00	0.00	0.00	0.00	0.00	0.00
G156.0	0.00	0.00	0.00	0.00	0.00	0.00	0.00	0.00	0.00	0.00	0.00	0.00	0.00
G157.0	0.00	0.00	0.00	0.00	0.00	0.00	0.00	0.00	0.00	0.00	0.00	0.00	0.00
G158.0	0.00	0.00	0.00	0.00	0.00	0.00	0.00	0.00	0.00	0.00	0.00	0.00	0.00
G159.0	0.00	0.00	0.00	0.00	0.00	0.00	0.00	0.00	0.00	0.00	0.00	0.00	0.00
G160.0	0.00	0.00	0.00	0.00	0.00	0.00	0.00	0.00	0.00	0.00	0.00	0.00	0.00
G161.0	0.00	0.00	0.00	0.00	0.00	0.00	0.00	0.00	0.00	0.00	0.00	0.00	0.00
G162.0	0.00	0.00	0.00	0.00	0.00	0.00	0.00	0.00	0.00	0.00	0.00	0.00	0.00
G163.0	0.00	0.00	0.00	0.00	0.00	0.00	0.00	0.00	0.00	0.00	0.00	0.00	0.00
G164.0	0.00	0.00	0.00	0.00	0.00	0.00	0.00	0.00	0.00	0.00	0.00	0.00	0.00
G165.0	0.00	0.00	0.00	0.00	0.00	0.00	0.00	0.00	0.00	0.00	0.00	0.00	0.00
G166.0	0.00	0.00	0.00	0.00	0.00	0.00	0.00	0.00	0.00	0.00	0.00	0.00	0.00
G167.0	0.00	0.00	0.00	0.00	0.00	0.00	0.00	0.00	0.00	0.00	0.00	0.00	0.00
G168.0	0.00	0.00	0.00	0.00	0.00	0.00	0.00	0.00	0.00	0.00	0.00	0.00	0.00
G169.0	0.00	0.00	0.00	0.00	0.00	0.00	0.00	0.00	0.00	0.00	0.00	0.00	0.00
G170.0	0.00	0.00	0.00	0.00	0.00	0.00	0.00	0.00	0.00	0.00	0.00	0.00	0.00
G171.0	0.00	0.00	0.00	0.00	0.00	0.00	0.00	0.00	0.00	0.00	0.00	0.00	0.00
G172.0	0.00	0.00	0.00	0.00	0.00	0.00	0.00	0.00	0.00	0.00	0.00	0.00	0.00
G173.0	0.00	0.00	0.00	0.00	0.00	0.00	0.00	0.00	0.00	0.00	0.00	0.00	0.00
G174.0	0.00	0.00	0.00	0.00	0.00	0.00	0.00	0.00	0.00	0.00	0.00	0.00	0.00
G175.0	0.00	0.00	0.00	0.00	0.00	0.00	0.00	0.00	0.00	0.00	0.00	0.00	0.00
G176.0	0.00	0.00	0.00	0.00	0.00	0.00	0.00	0.00	0.00	0.00	0.00	0.00	0.00
G177.0	0.00	0.00	0.00	0.00	0.00	0.00	0.00	0.00	0.00	0.00	0.00	0.00	0.00
G178.0	0.00	0.00	0.00	0.00	0.00	0.00	0.00	0.00	0.00	0.00	0.00	0.00	0.00
G179.0	0.00	0.00	0.00	0.00	0.00	0.00	0.00	0.00	0.00	0.00	0.00	0.00	0.00
G180.0	0.00	0.00	0.00	0.00	0.00	0.00	0.00	0.00	0.00	0.00	0.00	0.00	0.00



Apparecchio	Rilievo	Lampada
Codice ITALO 1 0F6 OP-DX 3.5-1M	Codice 18-009-8001	Codice L-IT1-0F6-3000-525-1M-70-25
Nome ITALO 1 0F6 OP-DX 3.5-1M	Nome ITALO 1 0F6 OP-DX 3.5-1M	Numero 1
Archivio Eulumdat	Data 23-07-2018	Posizione

Flusso Apparecchio	4800.00 lm	Potenza Apparecchio	39.00 W	Efficacia	123.08 lm/W	Rendimento	100.00%
Flusso Lampade	4800.00 lm	Valore Massimo	781.25 cd/klm	Posizione	C=65.00 G=56.00	CG	Asimmetrico

Tabella Intensità Luminose - cd/klm Tabella 15/18

	C 130.00	C 135.00	C 140.00	C 145.00	C 150.00	C 155.00	C 160.00	C 165.00	C 170.00	C 175.00	C 180.00	C 185.00	C 190.00
G146.0	0.00	0.00	0.00	0.00	0.00	0.00	0.00	0.00	0.00	0.00	0.00	0.00	0.00
G147.0	0.00	0.00	0.00	0.00	0.00	0.00	0.00	0.00	0.00	0.00	0.00	0.00	0.00
G148.0	0.00	0.00	0.00	0.00	0.00	0.00	0.00	0.00	0.00	0.00	0.00	0.00	0.00
G149.0	0.00	0.00	0.00	0.00	0.00	0.00	0.00	0.00	0.00	0.00	0.00	0.00	0.00
G150.0	0.00	0.00	0.00	0.00	0.00	0.00	0.00	0.00	0.00	0.00	0.00	0.00	0.00
G151.0	0.00	0.00	0.00	0.00	0.00	0.00	0.00	0.00	0.00	0.00	0.00	0.00	0.00
G152.0	0.00	0.00	0.00	0.00	0.00	0.00	0.00	0.00	0.00	0.00	0.00	0.00	0.00
G153.0	0.00	0.00	0.00	0.00	0.00	0.00	0.00	0.00	0.00	0.00	0.00	0.00	0.00
G154.0	0.00	0.00	0.00	0.00	0.00	0.00	0.00	0.00	0.00	0.00	0.00	0.00	0.00
G155.0	0.00	0.00	0.00	0.00	0.00	0.00	0.00	0.00	0.00	0.00	0.00	0.00	0.00
G156.0	0.00	0.00	0.00	0.00	0.00	0.00	0.00	0.00	0.00	0.00	0.00	0.00	0.00
G157.0	0.00	0.00	0.00	0.00	0.00	0.00	0.00	0.00	0.00	0.00	0.00	0.00	0.00
G158.0	0.00	0.00	0.00	0.00	0.00	0.00	0.00	0.00	0.00	0.00	0.00	0.00	0.00
G159.0	0.00	0.00	0.00	0.00	0.00	0.00	0.00	0.00	0.00	0.00	0.00	0.00	0.00
G160.0	0.00	0.00	0.00	0.00	0.00	0.00	0.00	0.00	0.00	0.00	0.00	0.00	0.00
G161.0	0.00	0.00	0.00	0.00	0.00	0.00	0.00	0.00	0.00	0.00	0.00	0.00	0.00
G162.0	0.00	0.00	0.00	0.00	0.00	0.00	0.00	0.00	0.00	0.00	0.00	0.00	0.00
G163.0	0.00	0.00	0.00	0.00	0.00	0.00	0.00	0.00	0.00	0.00	0.00	0.00	0.00
G164.0	0.00	0.00	0.00	0.00	0.00	0.00	0.00	0.00	0.00	0.00	0.00	0.00	0.00
G165.0	0.00	0.00	0.00	0.00	0.00	0.00	0.00	0.00	0.00	0.00	0.00	0.00	0.00
G166.0	0.00	0.00	0.00	0.00	0.00	0.00	0.00	0.00	0.00	0.00	0.00	0.00	0.00
G167.0	0.00	0.00	0.00	0.00	0.00	0.00	0.00	0.00	0.00	0.00	0.00	0.00	0.00
G168.0	0.00	0.00	0.00	0.00	0.00	0.00	0.00	0.00	0.00	0.00	0.00	0.00	0.00
G169.0	0.00	0.00	0.00	0.00	0.00	0.00	0.00	0.00	0.00	0.00	0.00	0.00	0.00
G170.0	0.00	0.00	0.00	0.00	0.00	0.00	0.00	0.00	0.00	0.00	0.00	0.00	0.00
G171.0	0.00	0.00	0.00	0.00	0.00	0.00	0.00	0.00	0.00	0.00	0.00	0.00	0.00
G172.0	0.00	0.00	0.00	0.00	0.00	0.00	0.00	0.00	0.00	0.00	0.00	0.00	0.00
G173.0	0.00	0.00	0.00	0.00	0.00	0.00	0.00	0.00	0.00	0.00	0.00	0.00	0.00
G174.0	0.00	0.00	0.00	0.00	0.00	0.00	0.00	0.00	0.00	0.00	0.00	0.00	0.00
G175.0	0.00	0.00	0.00	0.00	0.00	0.00	0.00	0.00	0.00	0.00	0.00	0.00	0.00
G176.0	0.00	0.00	0.00	0.00	0.00	0.00	0.00	0.00	0.00	0.00	0.00	0.00	0.00
G177.0	0.00	0.00	0.00	0.00	0.00	0.00	0.00	0.00	0.00	0.00	0.00	0.00	0.00
G178.0	0.00	0.00	0.00	0.00	0.00	0.00	0.00	0.00	0.00	0.00	0.00	0.00	0.00
G179.0	0.00	0.00	0.00	0.00	0.00	0.00	0.00	0.00	0.00	0.00	0.00	0.00	0.00
G180.0	0.00	0.00	0.00	0.00	0.00	0.00	0.00	0.00	0.00	0.00	0.00	0.00	0.00



Apparecchio	Rilievo	Lampada
Codice ITALO 1 0F6 OP-DX 3.5-1M	Codice 18-009-8001	Codice L-IT1-0F6-3000-525-1M-70-25
Nome ITALO 1 0F6 OP-DX 3.5-1M	Nome ITALO 1 0F6 OP-DX 3.5-1M	Numero 1
Archivio Eulumdat	Data 23-07-2018	Posizione

Flusso Apparecchio	4800.00 lm	Potenza Apparecchio	39.00 W	Efficacia	123.08 lm/W	Rendimento	100.00%
Flusso Lampade	4800.00 lm	Valore Massimo	781.25 cd/klm	Posizione	C=65.00 G=56.00	CG	Asimmetrico

Tabella Intensità Luminose - cd/klm Tabella 16/18

	C 195.00	C 200.00	C 205.00	C 210.00	C 215.00	C 220.00	C 225.00	C 230.00	C 235.00	C 240.00	C 245.00	C 250.00	C 255.00
G146.0	0.00	0.00	0.00	0.00	0.00	0.00	0.00	0.00	0.00	0.00	0.00	0.00	0.00
G147.0	0.00	0.00	0.00	0.00	0.00	0.00	0.00	0.00	0.00	0.00	0.00	0.00	0.00
G148.0	0.00	0.00	0.00	0.00	0.00	0.00	0.00	0.00	0.00	0.00	0.00	0.00	0.00
G149.0	0.00	0.00	0.00	0.00	0.00	0.00	0.00	0.00	0.00	0.00	0.00	0.00	0.00
G150.0	0.00	0.00	0.00	0.00	0.00	0.00	0.00	0.00	0.00	0.00	0.00	0.00	0.00
G151.0	0.00	0.00	0.00	0.00	0.00	0.00	0.00	0.00	0.00	0.00	0.00	0.00	0.00
G152.0	0.00	0.00	0.00	0.00	0.00	0.00	0.00	0.00	0.00	0.00	0.00	0.00	0.00
G153.0	0.00	0.00	0.00	0.00	0.00	0.00	0.00	0.00	0.00	0.00	0.00	0.00	0.00
G154.0	0.00	0.00	0.00	0.00	0.00	0.00	0.00	0.00	0.00	0.00	0.00	0.00	0.00
G155.0	0.00	0.00	0.00	0.00	0.00	0.00	0.00	0.00	0.00	0.00	0.00	0.00	0.00
G156.0	0.00	0.00	0.00	0.00	0.00	0.00	0.00	0.00	0.00	0.00	0.00	0.00	0.00
G157.0	0.00	0.00	0.00	0.00	0.00	0.00	0.00	0.00	0.00	0.00	0.00	0.00	0.00
G158.0	0.00	0.00	0.00	0.00	0.00	0.00	0.00	0.00	0.00	0.00	0.00	0.00	0.00
G159.0	0.00	0.00	0.00	0.00	0.00	0.00	0.00	0.00	0.00	0.00	0.00	0.00	0.00
G160.0	0.00	0.00	0.00	0.00	0.00	0.00	0.00	0.00	0.00	0.00	0.00	0.00	0.00
G161.0	0.00	0.00	0.00	0.00	0.00	0.00	0.00	0.00	0.00	0.00	0.00	0.00	0.00
G162.0	0.00	0.00	0.00	0.00	0.00	0.00	0.00	0.00	0.00	0.00	0.00	0.00	0.00
G163.0	0.00	0.00	0.00	0.00	0.00	0.00	0.00	0.00	0.00	0.00	0.00	0.00	0.00
G164.0	0.00	0.00	0.00	0.00	0.00	0.00	0.00	0.00	0.00	0.00	0.00	0.00	0.00
G165.0	0.00	0.00	0.00	0.00	0.00	0.00	0.00	0.00	0.00	0.00	0.00	0.00	0.00
G166.0	0.00	0.00	0.00	0.00	0.00	0.00	0.00	0.00	0.00	0.00	0.00	0.00	0.00
G167.0	0.00	0.00	0.00	0.00	0.00	0.00	0.00	0.00	0.00	0.00	0.00	0.00	0.00
G168.0	0.00	0.00	0.00	0.00	0.00	0.00	0.00	0.00	0.00	0.00	0.00	0.00	0.00
G169.0	0.00	0.00	0.00	0.00	0.00	0.00	0.00	0.00	0.00	0.00	0.00	0.00	0.00
G170.0	0.00	0.00	0.00	0.00	0.00	0.00	0.00	0.00	0.00	0.00	0.00	0.00	0.00
G171.0	0.00	0.00	0.00	0.00	0.00	0.00	0.00	0.00	0.00	0.00	0.00	0.00	0.00
G172.0	0.00	0.00	0.00	0.00	0.00	0.00	0.00	0.00	0.00	0.00	0.00	0.00	0.00
G173.0	0.00	0.00	0.00	0.00	0.00	0.00	0.00	0.00	0.00	0.00	0.00	0.00	0.00
G174.0	0.00	0.00	0.00	0.00	0.00	0.00	0.00	0.00	0.00	0.00	0.00	0.00	0.00
G175.0	0.00	0.00	0.00	0.00	0.00	0.00	0.00	0.00	0.00	0.00	0.00	0.00	0.00
G176.0	0.00	0.00	0.00	0.00	0.00	0.00	0.00	0.00	0.00	0.00	0.00	0.00	0.00
G177.0	0.00	0.00	0.00	0.00	0.00	0.00	0.00	0.00	0.00	0.00	0.00	0.00	0.00
G178.0	0.00	0.00	0.00	0.00	0.00	0.00	0.00	0.00	0.00	0.00	0.00	0.00	0.00
G179.0	0.00	0.00	0.00	0.00	0.00	0.00	0.00	0.00	0.00	0.00	0.00	0.00	0.00
G180.0	0.00	0.00	0.00	0.00	0.00	0.00	0.00	0.00	0.00	0.00	0.00	0.00	0.00



Apparecchio	Rilievo	Lampada
Codice ITALO 1 0F6 OP-DX 3.5-1M	Codice 18-009-8001	Codice L-IT1-0F6-3000-525-1M-70-25
Nome ITALO 1 0F6 OP-DX 3.5-1M	Nome ITALO 1 0F6 OP-DX 3.5-1M	Numero 1
Archivio Eulumdat	Data 23-07-2018	Posizione

Flusso Apparecchio	4800.00 lm	Potenza Apparecchio	39.00 W	Efficacia	123.08 lm/W	Rendimento	100.00%
Flusso Lampade	4800.00 lm	Valore Massimo	781.25 cd/klm	Posizione	C=65.00 G=56.00	CG	Asimmetrico

Tabella Intensità Luminose - cd/klm Tabella 17/18

	C 260.00	C 265.00	C 270.00	C 275.00	C 280.00	C 285.00	C 290.00	C 295.00	C 300.00	C 305.00	C 310.00	C 315.00	C 320.00
G146.0	0.00	0.00	0.00	0.00	0.00	0.00	0.00	0.00	0.00	0.00	0.00	0.00	0.00
G147.0	0.00	0.00	0.00	0.00	0.00	0.00	0.00	0.00	0.00	0.00	0.00	0.00	0.00
G148.0	0.00	0.00	0.00	0.00	0.00	0.00	0.00	0.00	0.00	0.00	0.00	0.00	0.00
G149.0	0.00	0.00	0.00	0.00	0.00	0.00	0.00	0.00	0.00	0.00	0.00	0.00	0.00
G150.0	0.00	0.00	0.00	0.00	0.00	0.00	0.00	0.00	0.00	0.00	0.00	0.00	0.00
G151.0	0.00	0.00	0.00	0.00	0.00	0.00	0.00	0.00	0.00	0.00	0.00	0.00	0.00
G152.0	0.00	0.00	0.00	0.00	0.00	0.00	0.00	0.00	0.00	0.00	0.00	0.00	0.00
G153.0	0.00	0.00	0.00	0.00	0.00	0.00	0.00	0.00	0.00	0.00	0.00	0.00	0.00
G154.0	0.00	0.00	0.00	0.00	0.00	0.00	0.00	0.00	0.00	0.00	0.00	0.00	0.00
G155.0	0.00	0.00	0.00	0.00	0.00	0.00	0.00	0.00	0.00	0.00	0.00	0.00	0.00
G156.0	0.00	0.00	0.00	0.00	0.00	0.00	0.00	0.00	0.00	0.00	0.00	0.00	0.00
G157.0	0.00	0.00	0.00	0.00	0.00	0.00	0.00	0.00	0.00	0.00	0.00	0.00	0.00
G158.0	0.00	0.00	0.00	0.00	0.00	0.00	0.00	0.00	0.00	0.00	0.00	0.00	0.00
G159.0	0.00	0.00	0.00	0.00	0.00	0.00	0.00	0.00	0.00	0.00	0.00	0.00	0.00
G160.0	0.00	0.00	0.00	0.00	0.00	0.00	0.00	0.00	0.00	0.00	0.00	0.00	0.00
G161.0	0.00	0.00	0.00	0.00	0.00	0.00	0.00	0.00	0.00	0.00	0.00	0.00	0.00
G162.0	0.00	0.00	0.00	0.00	0.00	0.00	0.00	0.00	0.00	0.00	0.00	0.00	0.00
G163.0	0.00	0.00	0.00	0.00	0.00	0.00	0.00	0.00	0.00	0.00	0.00	0.00	0.00
G164.0	0.00	0.00	0.00	0.00	0.00	0.00	0.00	0.00	0.00	0.00	0.00	0.00	0.00
G165.0	0.00	0.00	0.00	0.00	0.00	0.00	0.00	0.00	0.00	0.00	0.00	0.00	0.00
G166.0	0.00	0.00	0.00	0.00	0.00	0.00	0.00	0.00	0.00	0.00	0.00	0.00	0.00
G167.0	0.00	0.00	0.00	0.00	0.00	0.00	0.00	0.00	0.00	0.00	0.00	0.00	0.00
G168.0	0.00	0.00	0.00	0.00	0.00	0.00	0.00	0.00	0.00	0.00	0.00	0.00	0.00
G169.0	0.00	0.00	0.00	0.00	0.00	0.00	0.00	0.00	0.00	0.00	0.00	0.00	0.00
G170.0	0.00	0.00	0.00	0.00	0.00	0.00	0.00	0.00	0.00	0.00	0.00	0.00	0.00
G171.0	0.00	0.00	0.00	0.00	0.00	0.00	0.00	0.00	0.00	0.00	0.00	0.00	0.00
G172.0	0.00	0.00	0.00	0.00	0.00	0.00	0.00	0.00	0.00	0.00	0.00	0.00	0.00
G173.0	0.00	0.00	0.00	0.00	0.00	0.00	0.00	0.00	0.00	0.00	0.00	0.00	0.00
G174.0	0.00	0.00	0.00	0.00	0.00	0.00	0.00	0.00	0.00	0.00	0.00	0.00	0.00
G175.0	0.00	0.00	0.00	0.00	0.00	0.00	0.00	0.00	0.00	0.00	0.00	0.00	0.00
G176.0	0.00	0.00	0.00	0.00	0.00	0.00	0.00	0.00	0.00	0.00	0.00	0.00	0.00
G177.0	0.00	0.00	0.00	0.00	0.00	0.00	0.00	0.00	0.00	0.00	0.00	0.00	0.00
G178.0	0.00	0.00	0.00	0.00	0.00	0.00	0.00	0.00	0.00	0.00	0.00	0.00	0.00
G179.0	0.00	0.00	0.00	0.00	0.00	0.00	0.00	0.00	0.00	0.00	0.00	0.00	0.00
G180.0	0.00	0.00	0.00	0.00	0.00	0.00	0.00	0.00	0.00	0.00	0.00	0.00	0.00



Apparecchio		Rilievo		Lampada	
Codice	ITALO 1 0F6 OP-DX 3.5-1M	Codice	18-009-8001	Codice	L-IT1-0F6-3000-525-1M-70-25
Nome	ITALO 1 0F6 OP-DX 3.5-1M	Nome	ITALO 1 0F6 OP-DX 3.5-1M	Numero	1
Archivio	Eulumdat	Data	23-07-2018	Posizione	

Flusso Apparecchio	4800.00 lm	Potenza Apparecchio	39.00 W	Efficacia	123.08 lm/W	Rendimento	100.00%
Flusso Lampade	4800.00 lm	Valore Massimo	781.25 cd/klm	Posizione	C=65.00 G=56.00	CG	Asimmetrico

Tabella Intensità Luminosa - cd/klm Tabella 18/18

	C 325.00	C 330.00	C 335.00	C 340.00	C 345.00	C 350.00	C 355.00
G146.0	0.00	0.00	0.00	0.00	0.00	0.00	0.00
G147.0	0.00	0.00	0.00	0.00	0.00	0.00	0.00
G148.0	0.00	0.00	0.00	0.00	0.00	0.00	0.00
G149.0	0.00	0.00	0.00	0.00	0.00	0.00	0.00
G150.0	0.00	0.00	0.00	0.00	0.00	0.00	0.00
G151.0	0.00	0.00	0.00	0.00	0.00	0.00	0.00
G152.0	0.00	0.00	0.00	0.00	0.00	0.00	0.00
G153.0	0.00	0.00	0.00	0.00	0.00	0.00	0.00
G154.0	0.00	0.00	0.00	0.00	0.00	0.00	0.00
G155.0	0.00	0.00	0.00	0.00	0.00	0.00	0.00
G156.0	0.00	0.00	0.00	0.00	0.00	0.00	0.00
G157.0	0.00	0.00	0.00	0.00	0.00	0.00	0.00
G158.0	0.00	0.00	0.00	0.00	0.00	0.00	0.00
G159.0	0.00	0.00	0.00	0.00	0.00	0.00	0.00
G160.0	0.00	0.00	0.00	0.00	0.00	0.00	0.00
G161.0	0.00	0.00	0.00	0.00	0.00	0.00	0.00
G162.0	0.00	0.00	0.00	0.00	0.00	0.00	0.00
G163.0	0.00	0.00	0.00	0.00	0.00	0.00	0.00
G164.0	0.00	0.00	0.00	0.00	0.00	0.00	0.00
G165.0	0.00	0.00	0.00	0.00	0.00	0.00	0.00
G166.0	0.00	0.00	0.00	0.00	0.00	0.00	0.00
G167.0	0.00	0.00	0.00	0.00	0.00	0.00	0.00
G168.0	0.00	0.00	0.00	0.00	0.00	0.00	0.00
G169.0	0.00	0.00	0.00	0.00	0.00	0.00	0.00
G170.0	0.00	0.00	0.00	0.00	0.00	0.00	0.00
G171.0	0.00	0.00	0.00	0.00	0.00	0.00	0.00
G172.0	0.00	0.00	0.00	0.00	0.00	0.00	0.00
G173.0	0.00	0.00	0.00	0.00	0.00	0.00	0.00
G174.0	0.00	0.00	0.00	0.00	0.00	0.00	0.00
G175.0	0.00	0.00	0.00	0.00	0.00	0.00	0.00
G176.0	0.00	0.00	0.00	0.00	0.00	0.00	0.00
G177.0	0.00	0.00	0.00	0.00	0.00	0.00	0.00
G178.0	0.00	0.00	0.00	0.00	0.00	0.00	0.00
G179.0	0.00	0.00	0.00	0.00	0.00	0.00	0.00
G180.0	0.00	0.00	0.00	0.00	0.00	0.00	0.00

**CALCOLI
ILLUMINOTECNICI AREE
DI PROPRIETA'
BRICOMAN**

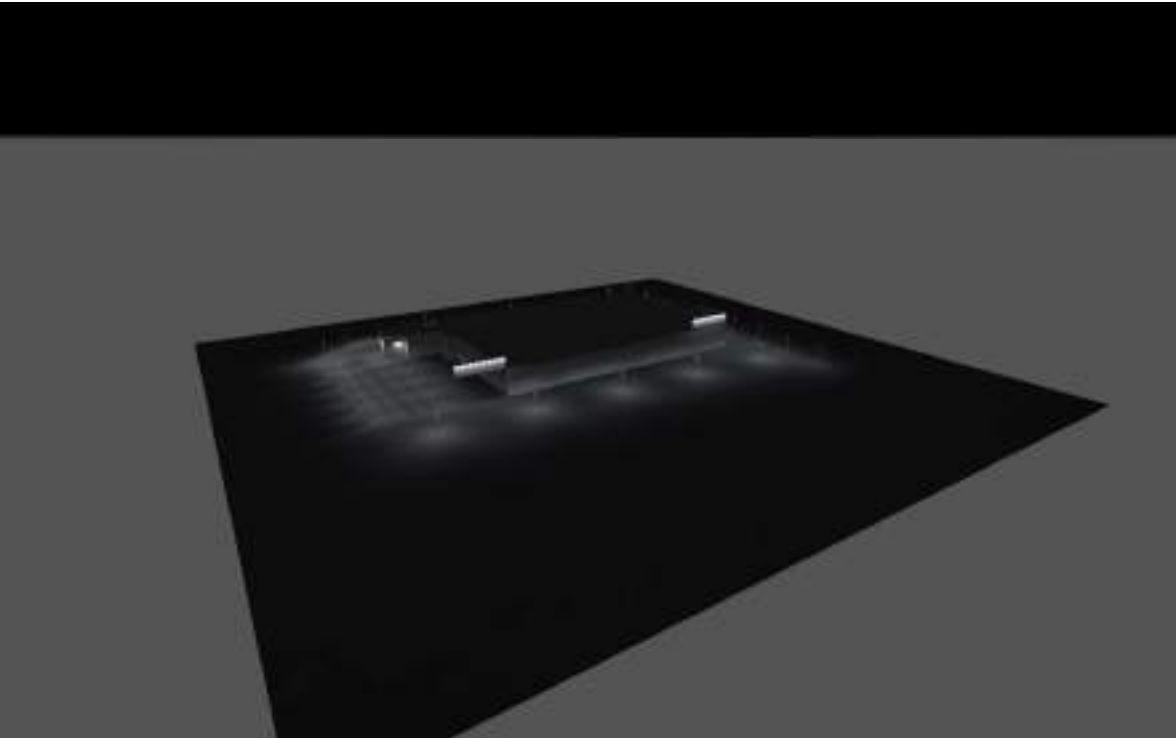

BRICOMAN AREE ESTERNE

Lista lampade

Φ_{totale} 768248 lm	P_{totale} 6236.0 W	Efficienza 123.2 lm/W
-------------------------------------	---------------------------------	--------------------------

Pz.	Produttore	Articolo No.	Nome articolo	P	Φ	Efficienza
30	Disano Illuminazione S.p.A	331051-39	3480 Mini Giovi - high performance - grandi aree 3000K CRI 70 68W CLD Grafite	68.0 W	8759 lm	128.8 lm/W
13	Disano Illuminazione S.p.A	414752-39	1887 Rodio LED - asimmetrico 3000K CRI 80 118W CLD Grafite	118.0 W	15942 lm	135.1 lm/W
2	Disano Illuminazione S.p.A	414753-39	1887 Rodio LED - asimmetrico 3000K CRI 80 157W CLD Grafite	157.0 W	19551 lm	124.5 lm/W
14	Disano Illuminazione S.p.A	414776-39	1892 Rodio LED - ottica stradale 3000K CRI 80 118W CLD Grafite	118.0 W	14551 lm	123.3 lm/W
24	Disano Illuminazione S.p.A	414860-39	1980 Micro Rodio - COB 3000K CRI 90 29W CLD Grafite	29.0 W	2309 lm	79.6 lm/W

Scheda tecnica prodotto

Disano Illuminazione S.p.A - 1887 Rodio LED - asimmetrico 3000K CRI 80 118W CLD Grafite



Articolo No.	414752-39
P	118.0 W
$\Phi_{Lampadina}$	15942 lm
$\Phi_{Lampada}$	15942 lm
η	100.00 %
Efficienza	135.1 lm/W
CCT	3000 K
CRI	80

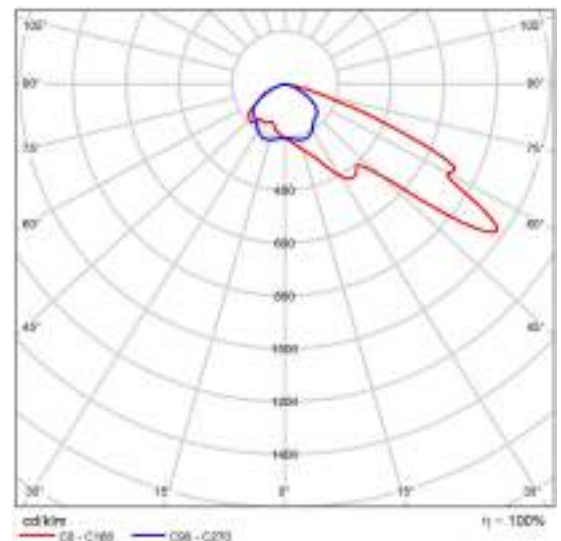

CDL polare

Corpo: in alluminio pressofuso con alette di raffreddamento integrate nella copertura. Ottica: in PMMA ad alto rendimento resistente alle alte temperature e ai raggi UV. Diffusore: vetro temperato sp. 5mm, resistente agli shock termici e agli urti (UNI EN 12150-1:2001). Verniciatura: fase di pretrattamento superficiale del metallo, verniciatura con polvere poliestere, resistente alla corrosione, alle nebbie saline, stabilizzata ai raggi UV. Verniciatura speciale: -verniciatura conforme UNI EN ISO 9227 (Test di corrosione in atmosfera artificiale per ambienti aggressivi) -trattamento di conformal coating sottocodice -38 ad elevata resistenza chimica per ambienti con un'alta concentrazione di cloro. Dissipatore: il sistema di dissipazione del calore è appositamente studiato e realizzato per permettere il funzionamento dei LED con temperature idonee per garantire ottime prestazioni/rendimento ed un'elevata durata di vita. Low flicker: apparecchio con Flicker molto contenuto: luce uniforme per una maggior sicurezza visiva. Rischio fotobiologico: gruppo di rischio esente, secondo la norma EN62471. Norme di riferimento: EN60598-1. Hanno grado di protezione secondo la norma EN60529. Equipaggiamento - Dotazione: -completo di staffa zincata e verniciata -connettore rapido IP68 -dispositivo di protezione conforme EN 61547 contro i fenomeni impulsivi -valvola

Scheda tecnica prodotto

Disano Illuminazione S.p.A - 1887 Rodio LED - asimmetrico 3000K CRI 80 118W CLD Grafite

anticondensa -guarnizione in gomma siliconica -viterie esterne in acc.inoxA richiesta: - protezione fino a 10KV. - Mezzanotte virtuale (sottocodice -30) - led ambra (sottocodice -73 - 2200K) - possibilità di gestione del punto-luce centralizzata o con sensori di presenza/ luminosità esterni.

Scheda tecnica prodotto

Disano Illuminazione S.p.A - 1887 Rodio LED - asimmetrico 3000K CRI 80 157W CLD Grafite



Articolo No.	414753-39
P	157.0 W
$\Phi_{Lampadina}$	19551 lm
$\Phi_{Lampada}$	19551 lm
η	100.00 %
Efficienza	124.5 lm/W
CCT	3000 K
CRI	80

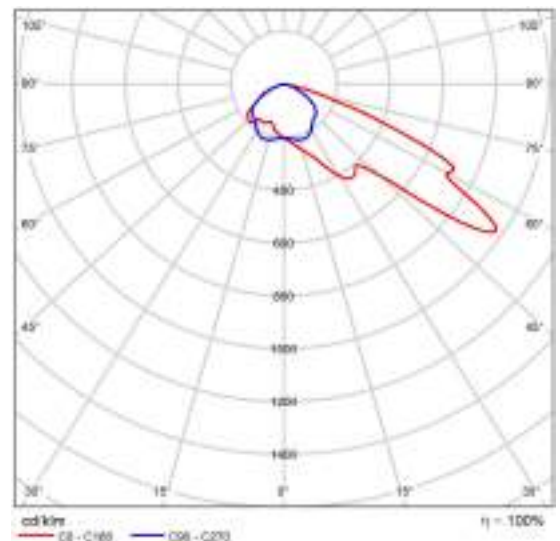

CDL polare

Corpo: in alluminio pressofuso con alette di raffreddamento integrate nella copertura. Ottica: in PMMA ad alto rendimento resistente alle alte temperature e ai raggi UV. Diffusore: vetro temperato sp. 5mm, resistente agli shock termici e agli urti (UNI EN 12150-1:2001). Verniciatura: fase di pretrattamento superficiale del metallo, verniciatura con polvere poliestere, resistente alla corrosione, alle nebbie saline, stabilizzata ai raggi UV. Verniciatura speciale: -verniciatura conforme UNI EN ISO 9227 (Test di corrosione in atmosfera artificiale per ambienti aggressivi) -trattamento di conformal coating sottocodice -38 ad elevata resistenza chimica per ambienti con un'alta concentrazione di cloro. Dissipatore: il sistema di dissipazione del calore è appositamente studiato e realizzato per permettere il funzionamento dei LED con temperature idonee per garantire ottime prestazioni/rendimento ed un'elevata durata di vita. Low flicker: apparecchio con Flicker molto contenuto: luce uniforme per una maggior sicurezza visiva. Rischio fotobiologico: gruppo di rischio esente, secondo la norma EN62471. Norme di riferimento: EN60598-1. Hanno grado di protezione secondo la norma EN60529. Equipaggiamento - Dotazione: -completo di staffa zincata e verniciata -connettore rapido IP68 -dispositivo di protezione conforme EN 61547 contro i fenomeni impulsivi -valvola

Scheda tecnica prodotto

Disano Illuminazione S.p.A - 1887 Rodio LED - asimmetrico 3000K CRI 80 157W CLD Grafite

anticondensa -guarnizione in gomma siliconica -viterie esterne in acc.inoxA richiesta: - protezione fino a 10KV. - Mezzanotte virtuale (sottocodice -30) - led ambra (sottocodice -73 - 2200K) - possibilità di gestione del punto-luce centralizzata o con sensori di presenza/ luminosità esterni.

Scheda tecnica prodotto

Disano Illuminazione S.p.A - 1892 Rodio LED - ottica stradale 3000K CRI 80 118W CLD Grafite



Articolo No.	414776-39
P	118.0 W
$\Phi_{Lampadina}$	14551 lm
$\Phi_{Lampada}$	14551 lm
η	100.00 %
Efficienza	123.3 lm/W
CCT	3000 K
CRI	80

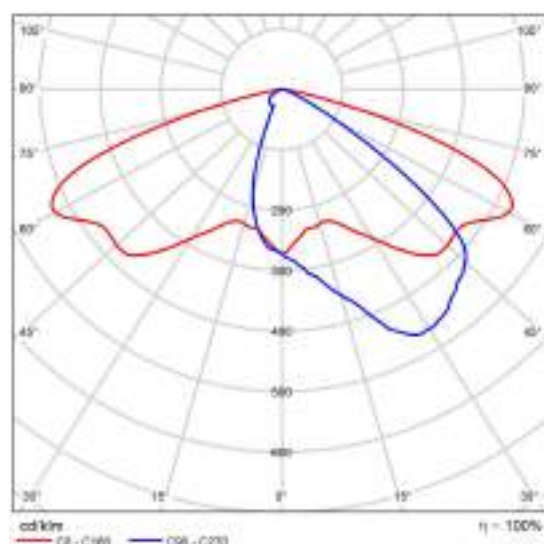

CDL polare

Corpo: in alluminio pressofuso con alette di raffreddamento integrate nella copertura. Ottica: in PMMA ad alto rendimento resistente alle alte temperature e ai raggi UV. Diffusore: vetro temperato sp. 5mm, resistente agli shock termici e agli urti (UNI EN 12150-1:2001). Verniciatura: fase di pretrattamento superficiale del metallo, verniciatura con polvere poliestere, resistente alla corrosione, alle nebbie saline, stabilizzata ai raggi UV. Verniciatura speciale: a richiesta: verniciatura conforme alla norma UNI EN ISO 9227, test di corrosione in atmosfera artificiale per ambienti aggressivi o marini (fronte mare). Dissipatore: il sistema di dissipazione del calore è appositamente studiato e realizzato per permettere il funzionamento dei LED con temperature idonee per garantire ottime prestazioni/rendimento ed un' elevata durata di vita. Low flicker: apparecchio con Flicker molto contenuto: luce uniforme per una maggior sicurezza visiva. Rischio fotobiologico: gruppo di rischio esente, secondo la norma EN62471. Norme di riferimento: EN60598-1. Hanno grado di protezione secondo la norma EN60529. Equipaggiamento - Dotazione: -completo di staffa zincata e verniciata -connettore rapido IP68 -dispositivo di protezione conforme EN 61547 contro i fenomeni impulsivi -valvola anticondensa -guarnizione in gomma siliconica -viterie esterne in acc.inoxA richiesta: - protezione fino a 10KV. - Mezzanotte virtuale

Scheda tecnica prodotto

Disano Illuminazione S.p.A - 1892 Rodio LED - ottica stradale 3000K CRI 80 118W CLD Grafite

(sottocodice -30) - led ambra (sottocodice -73 - 2200K) - possibilità di gestione del punto-luce centralizzata o con sensori di presenza/ luminosità esterni.

Scheda tecnica prodotto

Disano Illuminazione S.p.A - 1980 Micro Rodio - COB 3000K CRI 90 29W CLD Grafite



Articolo No.	414860-39
P	29.0 W
$\Phi_{Lampadina}$	2309 lm
$\Phi_{Lampada}$	2309 lm
η	99.99 %
Efficienza	79.6 lm/W
CCT	3000 K
CRI	90

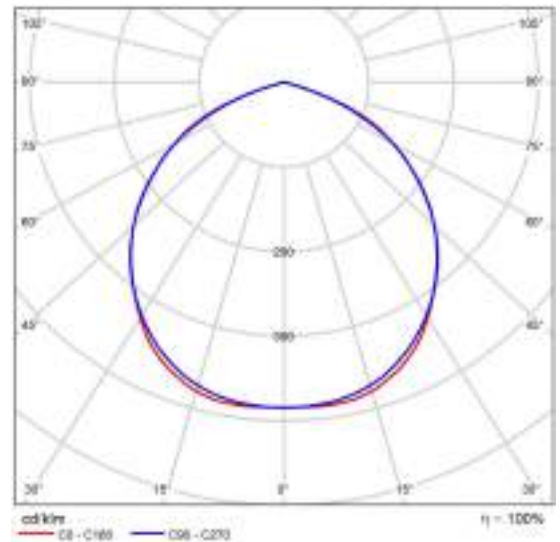

CDL polare

Corpo: in alluminio pressofuso con alette di raffreddamento integrate nella copertura. Ottica: in alluminio prismaticizzato e brillantato ad alto rendimento. Diffusore: vetro temperato sp. 4mm, resistente agli shock termici e agli urti (UNI EN 12150-1:2001). Verniciatura: fase di pretrattamento superficiale del metallo, verniciatura con polvere poliesteri, resistente alla corrosione, alle nebbie saline, stabilizzata ai raggi UV. Verniciatura speciale: a richiesta: verniciatura conforme alla norma UNI EN ISO 9227, test di corrosione in atmosfera artificiale per ambienti aggressivi o marini (fronte mare). Dissipatore: il sistema di dissipazione del calore è appositamente studiato e realizzato per permettere il funzionamento dei LED con temperature idonee per garantire ottime prestazioni/rendimento ed un' elevata durata di vita. LED: 80%: 50000h (L80B20) Low flicker: apparecchio con Flicker molto contenuto: luce uniforme per una maggior sicurezza visiva. Rischio fotobiologico: gruppo di rischio esente, secondo la norma EN62471. Norme di riferimento: EN60598-1. Hanno grado di protezione secondo la norma EN60529. Registered Design DM/100271. Equipaggiamento - Dotazione: -completo di staffa zincata e verniciata. -cavo per il collegamento elettrico. -dispositivo di protezione conforme EN 61547 contro i fenomeni impulsivi. -guarnizione in gomma silconica. -viterie esterne in

Valutazione di abbagliamento secondo UGR											
A - Sistema	A - Orient.	Lampada di tipo specularizzato					Lampada di tipo prismatico				
		70	75	80	85	90	70	75	80	85	90
A - Orientamento lampada		70	75	80	85	90	70	75	80	85	90
X	Y										
3H	3H	28.1	28.4	28.6	28.8	28.9	28.1	28.4	28.6	28.8	28.9
	3H	28.1	28.2	28.4	28.5	28.7	28.9	28.8	28.2	28.5	28.8
	4H	28.1	28.1	28.3	28.4	28.7	28.8	28.8	28.2	28.2	28.8
	5H	28.0	28.0	28.3	28.3	28.8	28.8	28.8	28.1	28.1	28.8
	6H	28.0	28.0	28.3	28.2	28.8	28.7	28.7	28.1	28.0	28.8
	12H	28.0	28.0	28.3	28.0	28.8	28.7	28.8	28.1	28.0	28.8
4H	3H	28.0	28.7	28.0	28.0	28.3	28.7	28.7	28.0	28.0	28.0
	3H	28.7	28.0	28.1	28.8	28.8	28.8	28.4	28.6	28.7	28.0
	4H	28.7	28.0	28.1	28.8	28.8	28.4	28.2	28.6	28.0	28.0
	5H	28.7	28.0	28.1	28.7	28.7	28.4	28.1	28.6	28.4	28.0
	6H	28.6	28.0	28.0	28.8	28.7	28.3	28.8	28.6	28.4	28.0
	12H	28.6	28.2	28.0	28.8	28.8	28.3	28.8	28.7	28.0	28.0
5H	4H	28.7	28.0	28.1	28.7	28.7	28.4	28.1	28.6	28.5	28.0
	5H	28.6	28.1	28.1	28.8	28.8	28.3	28.8	28.0	28.0	28.0
	6H	28.6	28.0	28.1	28.8	28.8	28.3	28.8	28.0	28.2	28.0
	12H	28.5	28.8	28.0	28.4	28.8	28.3	28.7	28.6	28.1	28.0
12H	4H	28.6	28.2	28.1	28.8	28.7	28.4	28.8	28.0	28.4	28.0
	5H	28.6	28.0	28.1	28.8	28.8	28.3	28.8	28.0	28.2	28.0
	6H	28.6	28.8	28.0	28.4	28.8	28.3	28.7	28.8	28.1	28.0

Diagramma UGR (SHR: 0.25)

Scheda tecnica prodotto

Disano Illuminazione S.p.A - 1980 Micro Rodio - COB 3000K CRI 90 29W CLD Grafite

acc.inox.Temperature Chart (Description): -20 °C ÷ +40 °CA richiesta: -
versione con sensore di presenza (sottocodice -19) - doppio
isolamento con (sottocodice -14) - cablaggio CLD-D-D (DALI)
(sottocodice -0041)

Scheda tecnica prodotto

Disano Illuminazione S.p.A - 3480 Mini Giovi - high performance - grandi aree 3000K CRI 70 68W CLD Grafite



Articolo No.	331051-39
P	68.0 W
$\Phi_{Lampadina}$	8759 lm
$\Phi_{Lampada}$	8759 lm
η	100.00 %
Efficienza	128.8 lm/W
CCT	3000 K
CRI	70

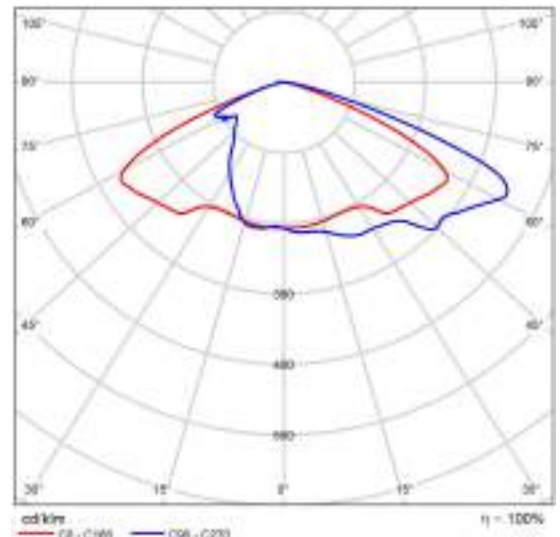

CDL polare

Corpo: in alluminio pressofuso Lega EN-AB 47100 disegnato con una sezione a bassissima superficie di esposizione al vento. Alette di raffreddamento integrate nella copertura. Il coperchio permette, una volta rimosso di accedere al vano accessori elettrici. Attacco palo: in alluminio pressofuso idoneo per pali di diametro da min.46mm a max.76mm orientabile da -20° a +10° per applicazione a frusta, e da 0° a +20° per applicazione a testa palo. Passo di inclinazione 5°. Ottica: in PMMA ad alto rendimento resistente alle alte temperature e ai raggi UV. Diffusore: vetro extra-chiaro sp. 4mm temperato resistente agli shock termici e agli urti (UNI-EN 12150-1:2001). Verniciatura: fase di pretrattamento superficiale del metallo, verniciatura con polvere poliestere, resistente alla corrosione, alle nebbie saline, stabilizzata ai raggi UV. Verniciatura speciale: a richiesta: verniciatura conforme alla norma UNI EN ISO 9227, test di corrosione in atmosfera artificiale per ambienti aggressivi o marini (fronte mare). Dissipatore: il sistema di dissipazione del calore è appositamente studiato e realizzato per permettere il funzionamento dei LED con temperature idonee per garantire ottime prestazioni/rendimento ed un' elevata durata di vita. Low flicker: apparecchio con Flicker molto contenuto: luce uniforme per una maggior sicurezza visiva. Rischio fotobiologico: gruppo di rischio esente, secondo la

Scheda tecnica prodotto

Disano Illuminazione S.p.A - 3480 Mini Giovi - high performance - grandi aree 3000K CRI 70 68W CLD Grafite

norma EN62471. Norme di riferimento: EN60598-1. Hanno grado di protezione secondo la norma EN60529. Registered Design DM/100271. Test di laboratorio (descrizione): conformi alle prove di vibrazione, con certificazione da ente terzo, secondo la norma ANSI C136.31: illuminazione stradale - Vibrazione degli apparecchi di illuminazione. Livello di prova: 3.0G livello 2 per installazione su ponti e cavalcavia. Equipaggiamento - Dotazione: - connettore rapido IP67. - valvola anticondensa. - dispositivo di controllo della temperatura con ripristino automatico. - dispositivo di protezione conforme alla EN 61547 contro i fenomeni impulsivi. - funzioni integrate ADVANCED PROG.A richiesta: funzione luce costante (CLO); idoneità al funzionamento in emergenza.

Area 1 (Scena luce 1)

Oggetti di calcolo

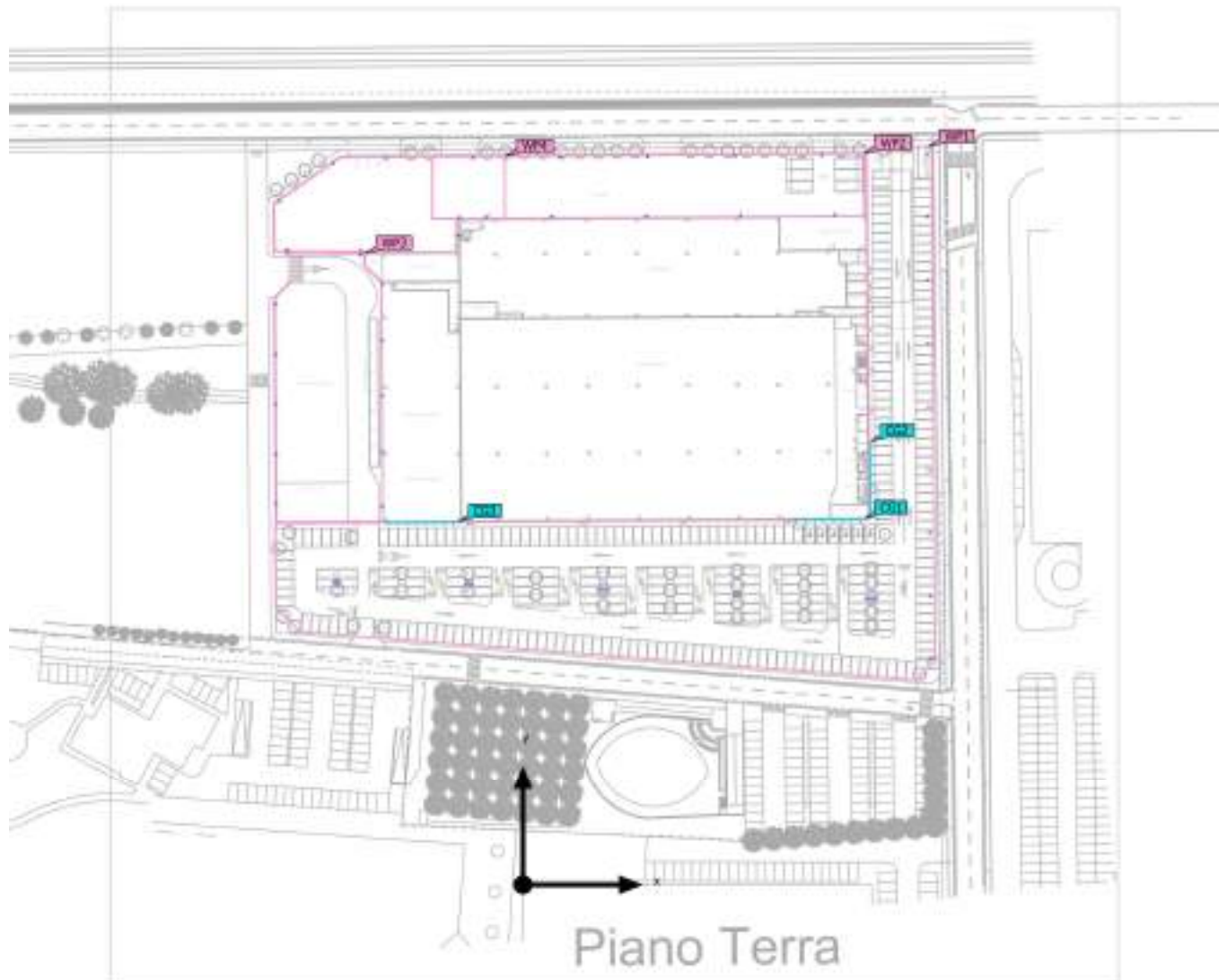

Area 1 (Scena luce 1)

Oggetti di calcolo

Superfici utili

Proprietà	\bar{E} (Nominale)	$E_{min.}$	E_{max}	g_1 (Nominale)	g_2	Indice
Superficie utile (Zona esterna 1) Illuminamento perpendicolare (adattivo) Altezza: 0.000 m, Zona margine: 0.000 m	23.7 lx	4.54 lx	93.6 lx	0.19	0.049	WP1
Superficie utile (Zona esterna 2) Illuminamento perpendicolare (adattivo) Altezza: 0.000 m, Zona margine: 0.000 m	52.7 lx	21.7 lx	123 lx	0.41	0.18	WP2
Superficie utile (Zona esterna 3) Illuminamento perpendicolare (adattivo) Altezza: 0.000 m, Zona margine: 0.000 m	49.3 lx	28.9 lx	99.7 lx	0.59	0.29	WP3
Superficie utile (Carico - Scarico) Illuminamento perpendicolare (adattivo) Altezza: 0.000 m, Zona margine: 0.000 m	81.7 lx	30.5 lx	123 lx	0.37	0.25	WP4

Superfici di calcolo

Proprietà	\bar{E}	$E_{min.}$	E_{max}	g_1	g_2	Indice
Superficie di calcolo 1 Illuminamento perpendicolare Altezza: 13.500 m	84.0 lx	8.97 lx	570 lx	0.11	0.016	CG1
Superficie di calcolo 2 Illuminamento perpendicolare Altezza: 13.500 m	82.9 lx	7.28 lx	727 lx	0.088	0.010	CG2
Superficie di calcolo 3 Illuminamento perpendicolare Altezza: 13.500 m	73.1 lx	5.34 lx	858 lx	0.073	0.006	CG3

Profilo di utilizzo: Preimpostazione DIALux (5.1.4 Standard (area di transito all'aperto))

Area 1 (Scena luce 1)

Superficie di calcolo 1

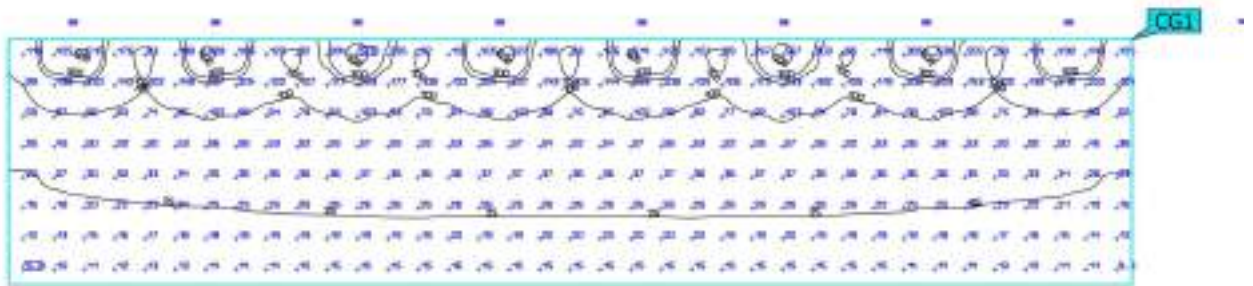
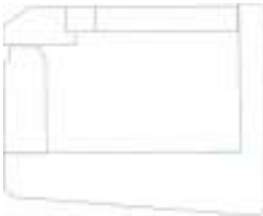

Proprietà	\bar{E}	$E_{min.}$	E_{max}	g_1	g_2	Indice
Superficie di calcolo 1 Illuminamento perpendicolare Altezza: 13.500 m	84.0 lx	8.97 lx	570 lx	0.11	0.016	CG1

Profilo di utilizzo: Preimpostazione DIALux (5.1.4 Standard (area di transito all'aperto))

Area 1 (Scena luce 1)

Superficie di calcolo 3

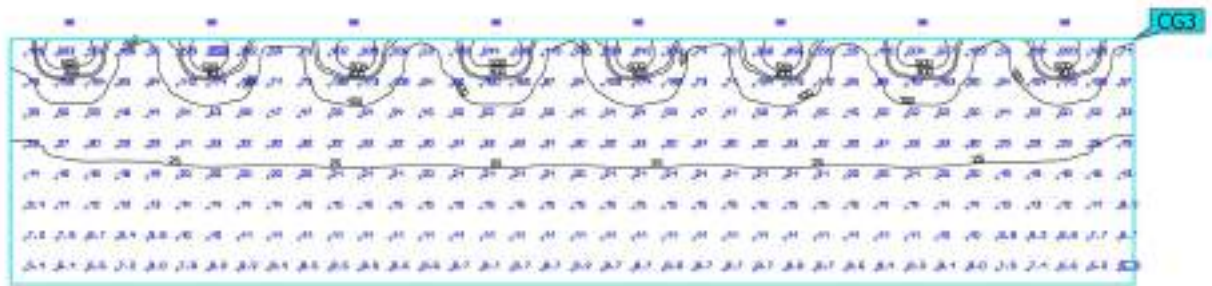
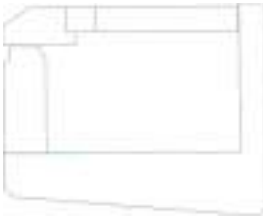

Proprietà	\bar{E}	$E_{min.}$	E_{max}	g_1	g_2	Indice
Superficie di calcolo 3 Illuminamento perpendicolare Altezza: 13.500 m	73.1 lx	5.34 lx	858 lx	0.073	0.006	CG3

Profilo di utilizzo: Preimpostazione DIALux (5.1.4 Standard (area di transito all'aperto))

Carico - Scarico (Scena luce 1)

Riepilogo

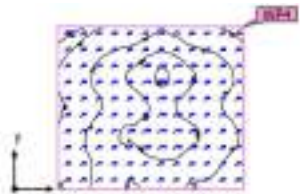

Base	334.48 m ²	Altezza di montaggio	7.990 m – 8.990 m
Fattore di diminuzione	0.80 (fisso)	Altezza superficie utile	0.000 m
		Zona margine superficie	0.000 m

Carico - Scarico (Scena luce 1)

Riepilogo

Risultati

	Unità	Calcolato	Nominale	Indice
Superficie utile	$\bar{E}_{\text{perpendicolare}}$	81.7 lx	≥ 50.0 lx	WP4
	g_1	0.37	≥ 0.40	WP4
Valori di consumo ⁽²⁾	Consumo	3784 kWh/a	max. 11750 kWh/a	
Locale	Valore di allacciamento specifico	1.29 W/m ²	-	
		1.58 W/m ² /100 lx	-	

(1) Basato su uno spazio rettangolare di 17.058 m X 19.609 m e SHR di 0.25.

(2) Calcolato utilizzando DIN:18599-4.

Profilo di utilizzo: Preimpostazione DIALux (5.1.4 Standard (area di transito all'aperto))

Lista lampade

Pz.	Produttore	Articolo No.	Nome articolo	R _{UG}	P	Φ	Efficienza
2	Disano Illuminazione S.p.A	414753-39	1887 Rodio LED - asimmetrico 3000K CRI 80 157W CLD Grafite	-	157.0 W	19551 lm	124.5 lm/W
1	Disano Illuminazione S.p.A	414776-39	1892 Rodio LED - ottica stradale 3000K CRI 80 118W CLD Grafite	-	118.0 W	14551 lm	123.3 lm/W

Carico - Scarico

Disposizione lampade



Carico - Scarico

Disposizione lampade

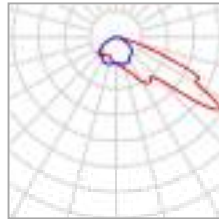

Produttore	Disano Illuminazione S.p.A	P	157.0 W
Articolo No.	414753-39	$\Phi_{Lampada}$	19551 lm
Nome articolo	1887 Rodio LED - asimmetrico 3000K CRI 80 157W CLD Grafite		
Dotazione	1x leds8_1887_36_700_5 5g_3k		

Lampade singole

X	Y	Altezza di montaggio	Lampada
11.875 m	0.284 m	8.990 m	2
19.042 m	0.329 m	8.990 m	3

Carico - Scarico

Disposizione lampade

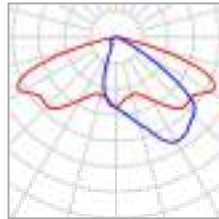

Produttore	Disano Illuminazione S.p.A	P	118.0 W
Articolo No.	414776-39	$\Phi_{Lampada}$	14551 lm
Nome articolo	1892 Rodio LED - ottica stradale 3000K CRI 80 118W CLD Grafite		
Dotazione	1x led_1892_118_3k		

6 x Disano Illuminazione 1892 Rodio LED - ottica stradale 3000K CRI 80 118W CLD Grafite

Tipo	Disposizione in fila	X	Y	Altezza di montaggio	Lampada
1ª lampada (X/Y/Z)	15.533 m / 16.622 m / 7.990 m	15.533 m	16.622 m	7.990 m	1
direzione X	6 Pz., Centro - centro, 23.593 m				
Disposizione	A1				

Carico - Scarico (Scena luce 1)

Oggetti di calcolo



Carico - Scarico (Scena luce 1)

Oggetti di calcolo

Superfici utili

Proprietà	\bar{E} (Nominale)	$E_{min.}$	E_{max}	g_1 (Nominale)	g_2	Indice
Superficie utile (Carico - Scarico) Illuminamento perpendicolare (adattivo) Altezza: 0.000 m, Zona margine: 0.000 m	81.7 lx	30.5 lx	123 lx	0.37	0.25	WP4

Profilo di utilizzo: Preimpostazione DIALux (5.1.4 Standard (area di transito all'aperto))

Immagini

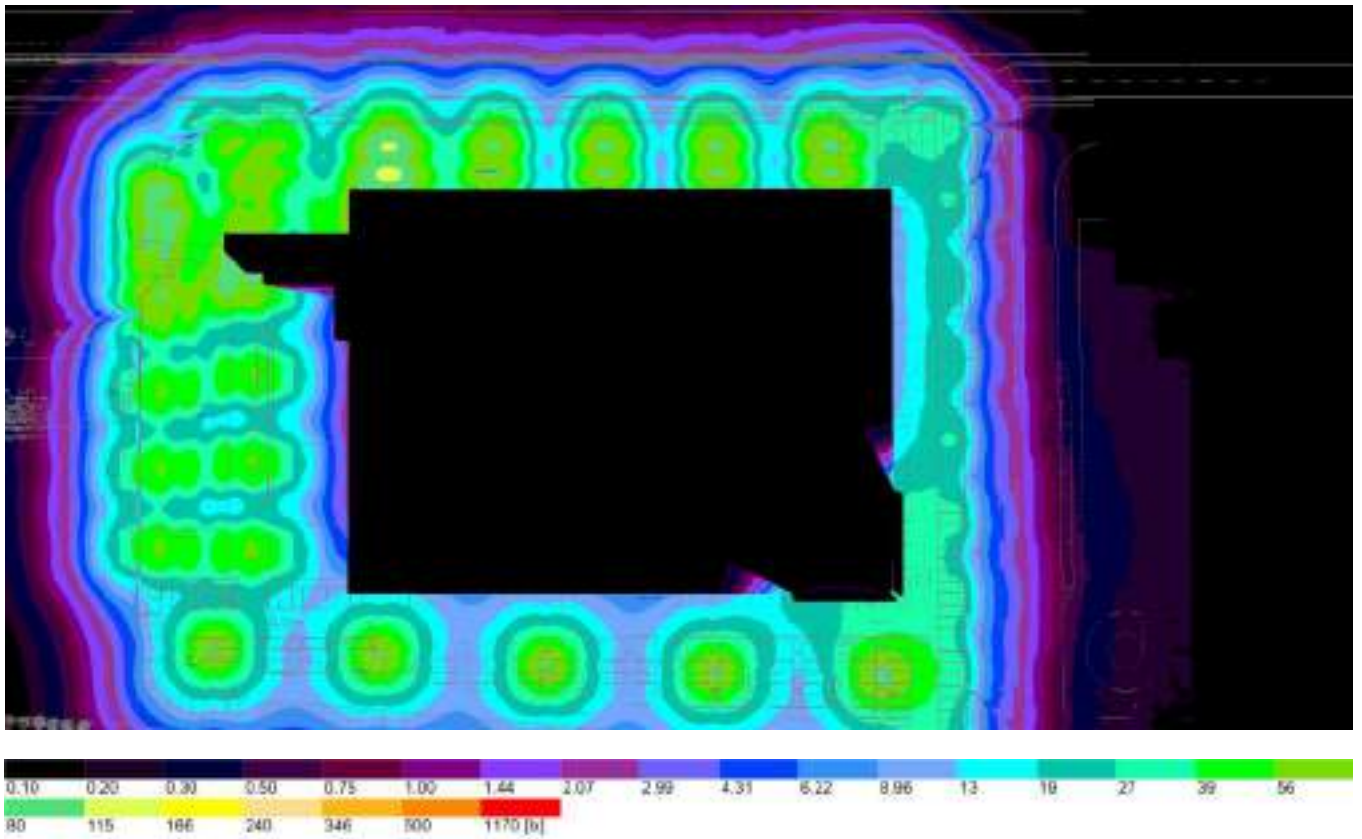

Area 1 (75)

Zona esterna 1 (Scena luce 1)

Riepilogo

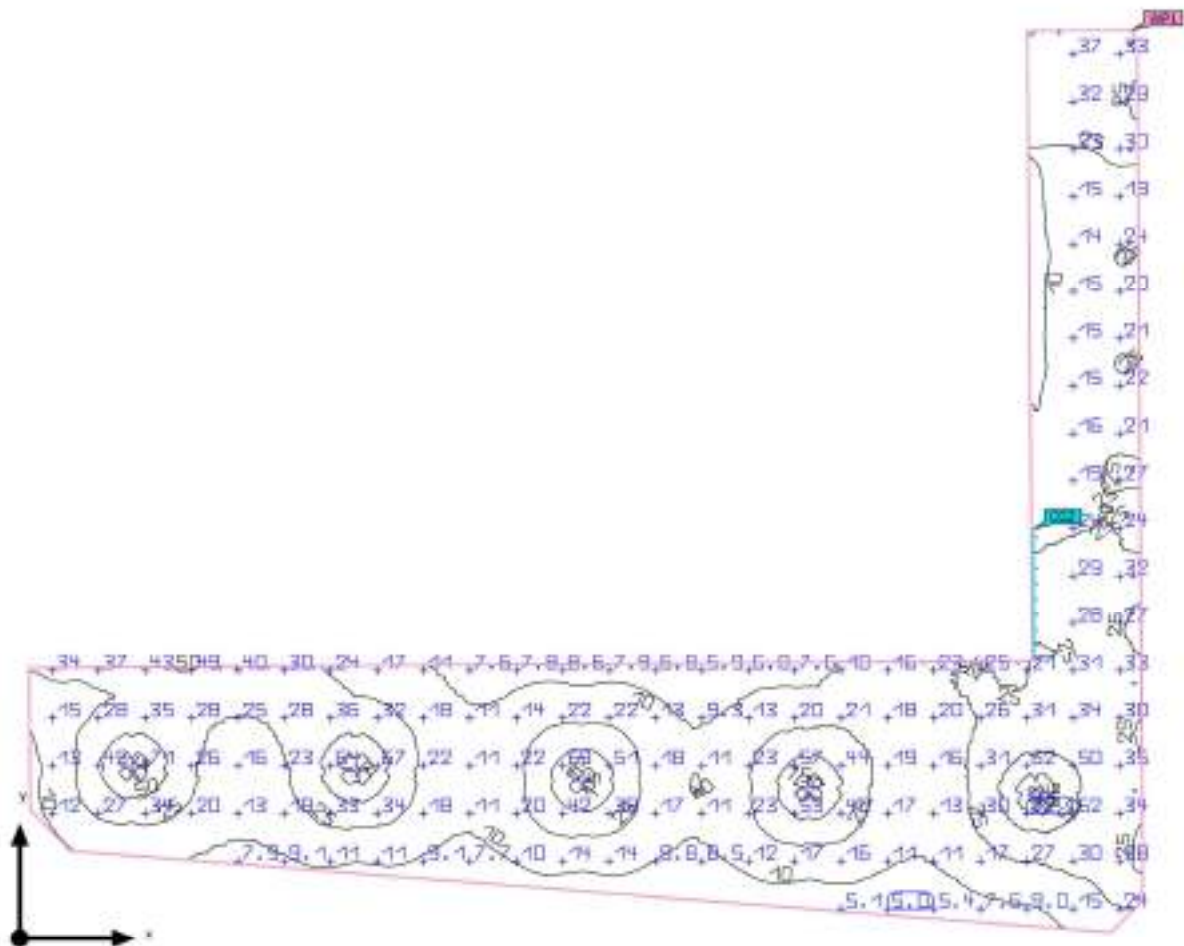

Base	8193.98 m ²	Altezza di montaggio	8.000 m - 16.000 m
Fattore di diminuzione	0.80 (fisso)	Altezza superficie utile	0.000 m
		Zona margine superficie	0.000 m

Zona esterna 1 (Scena luce 1)

Riepilogo

Risultati

	Unità	Calcolato	Nominale	Indice
Superficie utile	$\bar{E}_{\text{perpendicolare}}$	23.7 lx	≥ 20.0 lx	WP1
	g_1	0.19	≥ 0.25	WP1
Valutazione di abbagliamento ⁽¹⁾	$R_{UG, \text{max}}$	30	≤ -1	
Valori di consumo ⁽²⁾	Consumo	23967 kWh/a	max. 286800 kWh/a	
Locale	Valore di allacciamento specifico	0.33 W/m ²	-	
		1.41 W/m ² /100 lx	-	

(1) Basato su uno spazio rettangolare di 144.386 m X 178.116 m e SHR di 0.25.

(2) Calcolato utilizzando DIN:18599-4.

Profilo di utilizzo: Parcheggio (5.9.3 Traffico intenso, ad es. parcheggi davanti a scuole, chiese, centri commerciali grandi, impianti sportivi grandi e centri polifunzionali)

Lista lampade

Pz.	Produttore	Articolo No.	Nome articolo	R_{UG}	P	Φ	Efficienza
30	Disano Illuminazione S.p.A	331051-39	3480 Mini Giovi - high performance - grandi aree 3000K CRI 70 68W CLD Grafite	-	68.0 W	8759 lm	128.8 lm/W
24	Disano Illuminazione S.p.A	414860-39	1980 Micro Rodio - COB 3000K CRI 90 29W CLD Grafite	30	29.0 W	2309 lm	79.6 lm/W

Zona esterna 1 (Scena luce 1)

Oggetti di calcolo

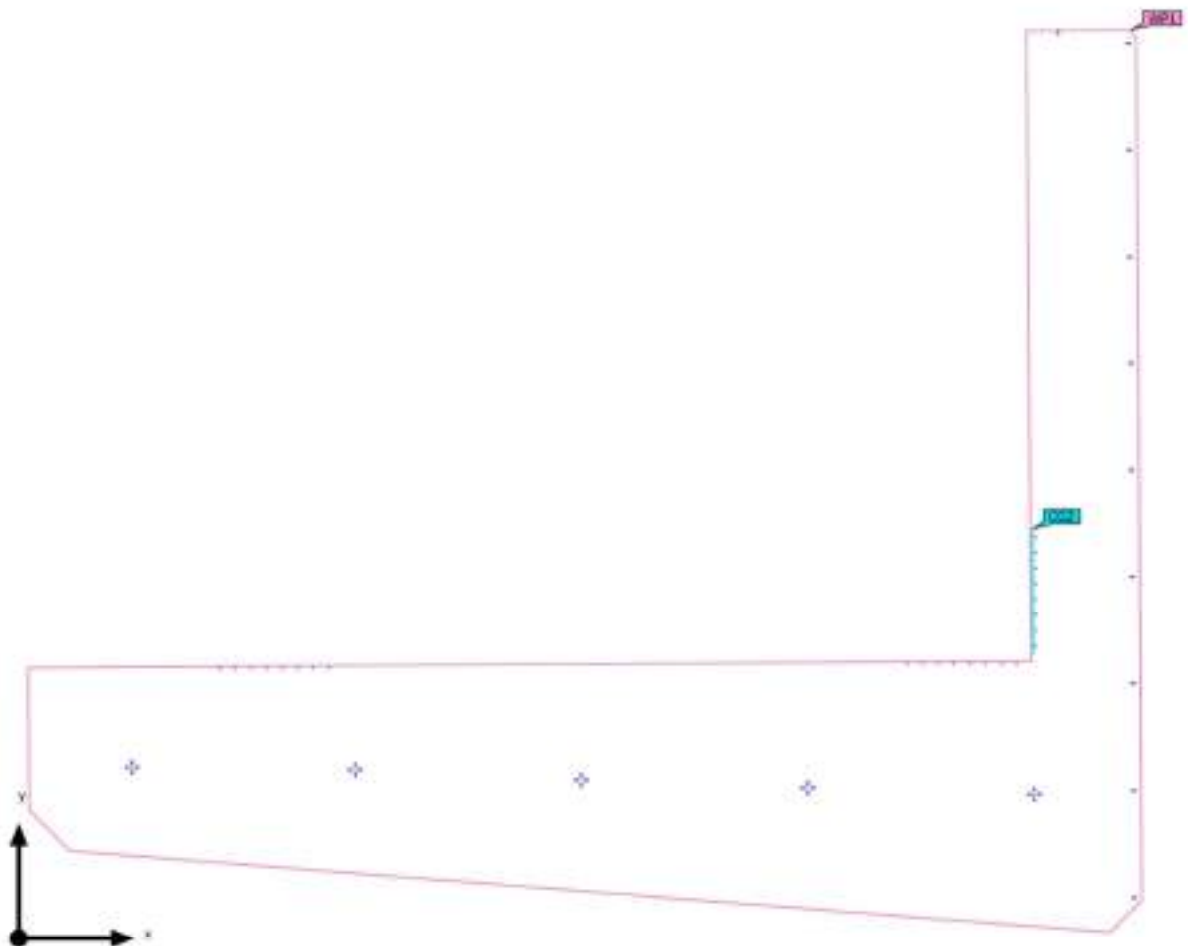

Zona esterna 1 (Scena luce 1)

Oggetti di calcolo

Superfici utili

Proprietà	\bar{E} (Nominale)	$E_{min.}$	E_{max}	g_1 (Nominale)	g_2	Indice
Superficie utile (Zona esterna 1) Illuminamento perpendicolare (adattivo) Altezza: 0.000 m, Zona margine: 0.000 m	23.7 lx	4.54 lx	93.6 lx	0.19	0.049	WP1

Superfici di calcolo

Proprietà	\bar{E}	$E_{min.}$	E_{max}	g_1	g_2	Indice
Superficie di calcolo 2 Illuminamento perpendicolare Altezza: 13.500 m	82.9 lx	7.28 lx	727 lx	0.088	0.010	CG2

Profilo di utilizzo: Parcheggio (5.9.3 Traffico intenso, ad es. parcheggi davanti a scuole, chiese, centri commerciali grandi, impianti sportivi grandi e centri polifunzionali)

Zona esterna 1 (Scena luce 1)

Superficie utile (Zona esterna 1)

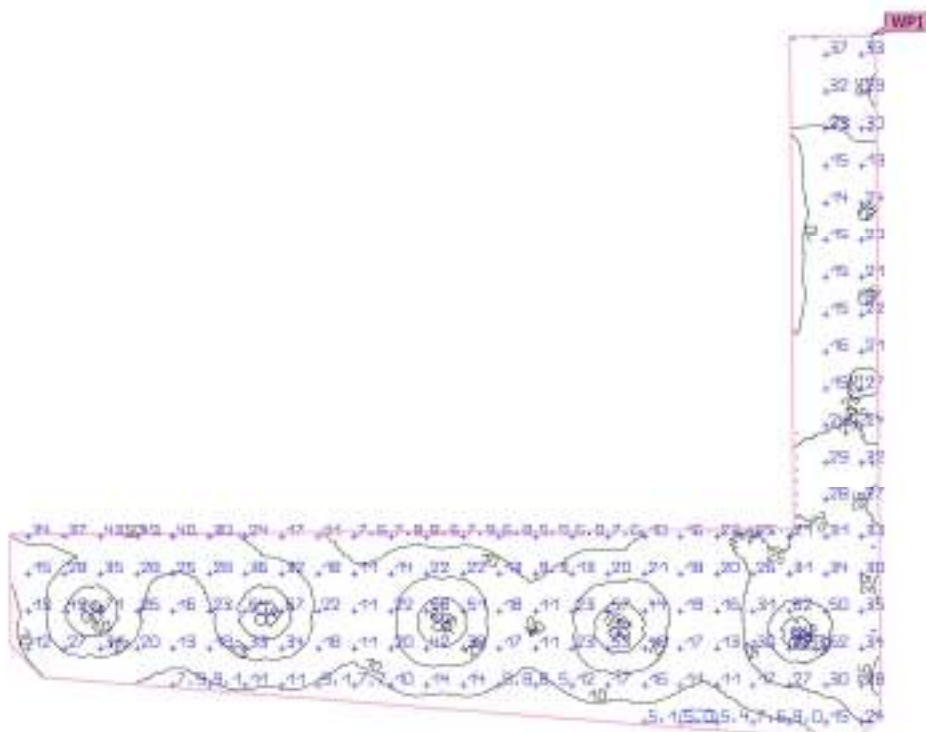

Proprietà	\bar{E} (Nominale)	$E_{min.}$	E_{max}	g_1 (Nominale)	g_2	Indice
Superficie utile (Zona esterna 1) Illuminamento perpendicolare (adattivo) Altezza: 0.000 m, Zona margine: 0.000 m	23.7 lx	4.54 lx	93.6 lx	0.19	0.049	WP1

Profilo di utilizzo: Parcheggi (5.9.3 Traffico intenso, ad es. parcheggi davanti a scuole, chiese, centri commerciali grandi, impianti sportivi grandi e centri polifunzionali)

Zona esterna 1 (Scena luce 1)

Superficie di calcolo 2

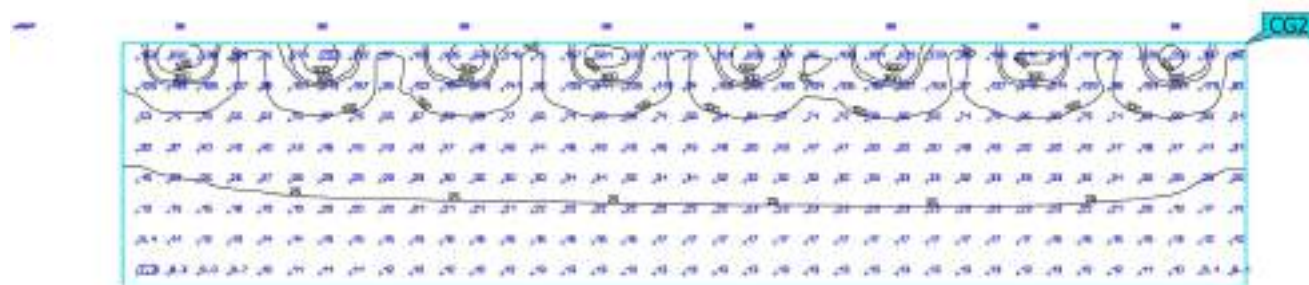

Proprietà	\bar{E}	$E_{min.}$	E_{max}	g_1	g_2	Indice
Superficie di calcolo 2 Illuminamento perpendicolare Altezza: 13.500 m	82.9 lx	7.28 lx	727 lx	0.088	0.010	CG2

Profilo di utilizzo: Parcheggi (5.9.3 Traffico intenso, ad es. parcheggi davanti a scuole, chiese, centri commerciali grandi, impianti sportivi grandi e centri polifunzionali)

Zona esterna 2 (Scena luce 1)

Riepilogo

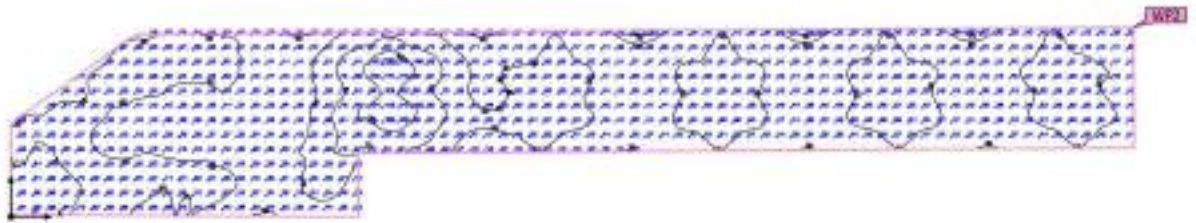

Base	3035.26 m ²	Altezza di montaggio	8.000 m – 9.000 m
Fattore di diminuzione	0.80 (fisso)	Altezza superficie utile	0.000 m
		Zona margine superficie	0.000 m

Zona esterna 2 (Scena luce 1)

Riepilogo

Risultati

	Unità	Calcolato	Nominale	Indice
Superficie utile	$\bar{E}_{\text{perpendicolare}}$	52.7 lx	≥ 50.0 lx	WP2
	g_1	0.41	≥ 0.40	WP2
Valori di consumo ⁽²⁾	Consumo	13438 kWh/a	max. 117950 kWh/a	
Locale	Valore di allacciamento specifico	0.51 W/m ²	-	
		0.96 W/m ² /100 lx	-	

(1) Basato su uno spazio rettangolare di 159.465 m X 26.075 m e SHR di 0.25.

(2) Calcolato utilizzando DIN:18599-4.

Profilo di utilizzo: Preimpostazione DIALux (5.1.4 Standard (area di transito all'aperto))

Lista lampade

Pz.	Produttore	Articolo No.	Nome articolo	R _{UG}	P	Φ	Efficienza
13	Disano Illuminazione S.p.A	414776-39	1892 Rodio LED - ottica stradale 3000K CRI 80 118W CLD Grafite	-	118.0 W	14551 lm	123.3 lm/W

Zona esterna 2 (Scena luce 1)

Oggetti di calcolo

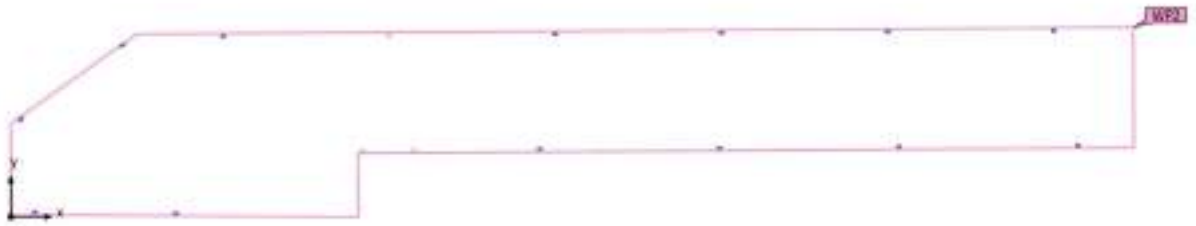

Zona esterna 2 (Scena luce 1)

Oggetti di calcolo

Superfici utili

Proprietà	\bar{E} (Nominale)	$E_{min.}$	E_{max}	g_1 (Nominale)	g_2	Indice
Superficie utile (Zona esterna 2) Illuminamento perpendicolare (adattivo) Altezza: 0.000 m, Zona margine: 0.000 m	52.7 lx	21.7 lx	123 lx	0.41	0.18	WP2

Profilo di utilizzo: Preimpostazione DIALux (5.1.4 Standard (area di transito all'aperto))

Zona esterna 2 (Scena luce 1)

Superficie utile (Zona esterna 2)

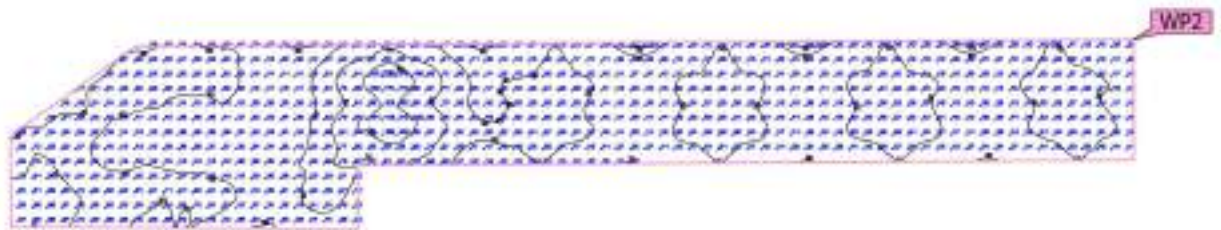

Proprietà	\bar{E} (Nominale)	$E_{min.}$	E_{max}	g_1 (Nominale)	g_2	Indice
Superficie utile (Zona esterna 2) Illuminamento perpendicolare (adattivo) Altezza: 0.000 m, Zona margine: 0.000 m	52.7 lx	21.7 lx	123 lx	0.41	0.18	WP2

Profilo di utilizzo: Preimpostazione DIALux (5.1.4 Standard (area di transito all'aperto))

Zona esterna 3 (Scena luce 1)

Riepilogo



Base	2025.55 m ²	Altezza di montaggio	8.000 m
Fattore di diminuzione	0.80 (fisso)	Altezza superficie utile	0.000 m
		Zona margine superficie	0.000 m

Zona esterna 3 (Scena luce 1)

Riepilogo

Risultati

	Unità	Calcolato	Nominale	Indice
Superficie utile	$\bar{E}_{\text{perpendicolare}}$	49.3 lx	≥ 50.0 lx	WP3
	g_1	0.59	≥ 0.40	WP3
Valori di consumo ⁽²⁾	Consumo	8269 kWh/a	max. 70900 kWh/a	
Locale	Valore di allacciamento specifico	0.47 W/m ²	-	
		0.95 W/m ² /100 lx	-	

(1) Basato su uno spazio rettangolare di 72.698 m X 28.819 m e SHR di 0.25.

(2) Calcolato utilizzando DIN:18599-4.

Profilo di utilizzo: Preimpostazione DIALux (5.1.4 Standard (area di transito all'aperto))

Lista lampade

Pz.	Produttore	Articolo No.	Nome articolo	R _{UG}	P	Φ	Efficienza
8	Disano Illuminazione S.p.A	414752-39	1887 Rodio LED - asimmetrico 3000K CRI 80 118W CLD Grafite	-	118.0 W	15942 lm	135.1 lm/W

Zona esterna 3 (Scena luce 1)

Oggetti di calcolo

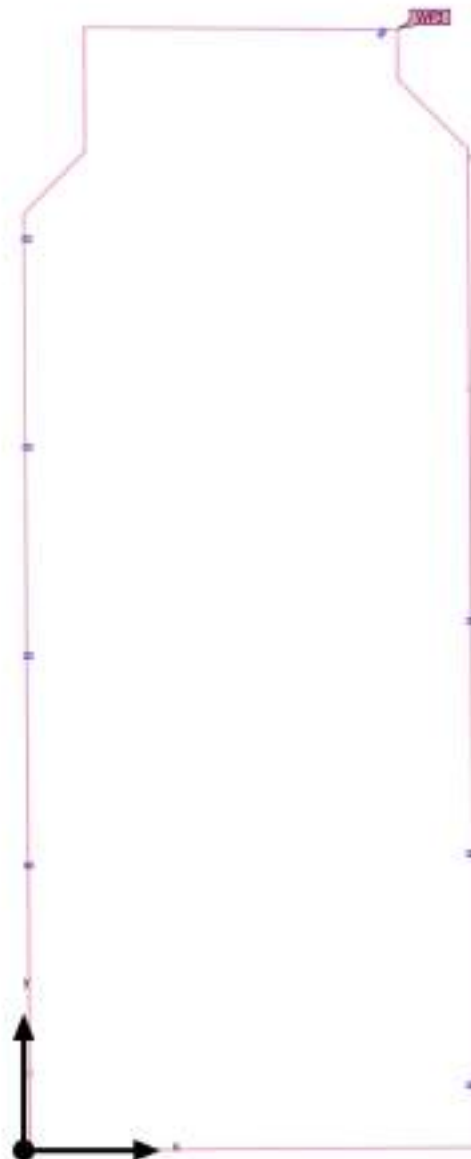

Zona esterna 3 (Scena luce 1)

Oggetti di calcolo

Superfici utili

Proprietà	\bar{E} (Nominale)	$E_{min.}$	E_{max}	g_1 (Nominale)	g_2	Indice
Superficie utile (Zona esterna 3) Illuminamento perpendicolare (adattivo) Altezza: 0.000 m, Zona margine: 0.000 m	49.3 lx	28.9 lx	99.7 lx	0.59	0.29	WP3

Profilo di utilizzo: Preimpostazione DIALux (5.1.4 Standard (area di transito all'aperto))

Zona esterna 3 (Scena luce 1)

Superficie utile (Zona esterna 3)



Proprietà	\bar{E} (Nominale)	$E_{min.}$	E_{max}	g_1 (Nominale)	g_2	Indice
Superficie utile (Zona esterna 3) Illuminamento perpendicolare (adattivo) Altezza: 0.000 m, Zona margine: 0.000 m	49.3 lx	28.9 lx	99.7 lx	0.59	0.29	WP3

Profilo di utilizzo: Preimpostazione DIALux (5.1.4 Standard (area di transito all'aperto))

BRICOMAN SCAFFALATURA

Redattore
Telefono
Fax
e-Mail

Indice

Progetto 1

Copertina progetto	1
Indice	2
Lista pezzi lampade	3
Disano Illuminazione SpA 963 44w CLD CELL 963 - Hydro LED - High pe...	
Scheda tecnica apparecchio	4
Disano 963 Hydro LED - High Performance Disano 963 LED 47W CLD GRIGIO	
Scheda tecnica apparecchio	5
Scena esterna 1	
Dati di pianificazione	6
Lista pezzi lampade	7
Superfici esterne	
Griglia di calcolo 1	
Riepilogo	8
Isolinee (E, perpendicolare)	9
Grafica dei valori (E, perpendicolare)	10

Redattore
Telefono
Fax
e-Mail

Progetto 1 / Lista pezzi lampade

18 Pezzo Disano Illuminazione SpA 963 44w CLD CELL 963 -
Hydro LED - High performance
Articolo No.: 963 44w CLD CELL
Flusso luminoso (Lampada): 7766 lm
Flusso luminoso (Lampadine): 7766 lm
Potenza lampade: 47.5 W
Classificazione lampade secondo CIE: 94
CIE Flux Code: 44 74 91 94 100
Dotazione: 1 x led_44w_963 (Fattore di correzione
1.000).

Per un'immagine della
lampada consultare il
nostro catalogo lampade.

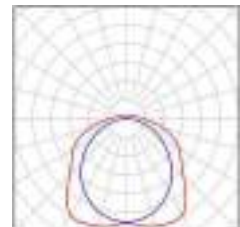

Redattore
Telefono
Fax
e-Mail

Disano Illuminazione SpA 963 44w CLD CELL 963 - Hydro LED - High performance / Scheda tecnica apparecchio

Emissione luminosa 1:

Per un'immagine della lampada consultare il nostro catalogo lampade.

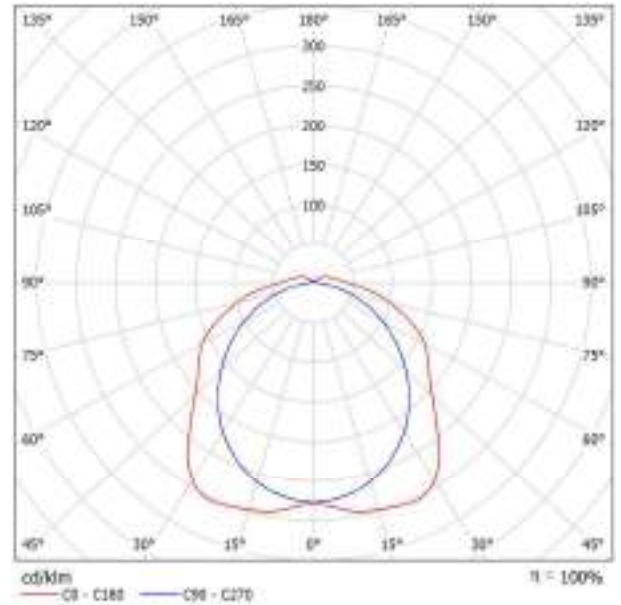

Classificazione lampade secondo CIE: 94
CIE Flux Code: 44 74 91 94 100

Emissione luminosa 1:

Valutazione di abbagliamento secondo UGR											
S		70	75	80	85	90	95	100	105	110	
D		30	35	40	45	50	55	60	65	70	
P		20	25	30	35	40	45	50	55	60	
Convezioni dal locale		Linea di vista perpendicolare all'asse della lampada					Linea di vista parallela all'asse della lampada				
X	Y										
2H	2H	20.8	21.1	21.2	21.4	21.8	22.1	22.5	22.8	23.1	23.2
	3H	22.6	23.8	23.9	24.1	24.3	24.4	24.8	25.2	25.5	25.7
	4H	23.4	24.3	24.8	24.9	25.1	25.2	25.6	26.0	26.3	26.4
	5H	24.1	25.1	24.5	25.5	26.9	27.2	27.3	27.7	28.1	28.1
	12H	24.4	25.4	24.8	25.8	28.1	28.2	28.3	28.7	29.1	29.1
4H	2H	21.1	21.4	21.7	21.8	22.2	22.5	22.8	23.1	23.2	23.2
	3H	23.1	24.3	23.8	24.7	25.2	25.3	25.7	26.1	26.4	26.4
	4H	24.1	25.1	24.8	25.6	26.1	26.2	26.6	27.0	27.3	27.3
	5H	25.1	26.0	25.7	26.4	27.3	27.3	27.7	28.1	28.5	28.5
	12H	25.4	26.1	26.1	26.8	27.3	27.4	27.7	28.1	28.5	28.5
8H	4H	24.6	25.3	25.1	25.8	26.4	26.3	26.7	27.1	27.4	27.4
	5H	25.7	26.1	26.1	26.8	27.4	27.4	27.8	28.2	28.5	28.5
	6H	26.1	26.7	26.8	27.1	27.8	27.8	28.2	28.6	28.9	28.9
	12H	26.4	27.1	27.1	27.8	28.3	28.4	28.8	29.2	29.5	29.5
	12H	4H	24.4	25.1	25.1	25.8	26.1	26.1	26.5	26.9	27.2
5H		25.8	26.1	26.1	26.8	27.3	27.3	27.7	28.1	28.4	28.4
6H		26.1	26.8	26.8	27.1	27.8	27.8	28.2	28.6	28.9	28.9
Variazioni delle posizioni differenziali per le distanze delle lampade L											
S = 1.0H		+0.1 / -0.1					+0.1 / -0.1				
S = 1.5H		+0.1 / -0.2					+0.1 / -0.2				
S = 2.0H		+0.2 / -0.2					+0.2 / -0.2				
Tabella standard		8405					8405				
Addebiato di		8.8					8.8				
Livello di abbagliamento con il valore di 770lm flux lampare dirette											

Redattore
 Telefono
 Fax
 e-Mail

Disano 963 Hydro LED - High Performance Disano 963 LED 47W CLD GRIGIO / Scheda tecnica apparecchio



Emissione luminosa 1:

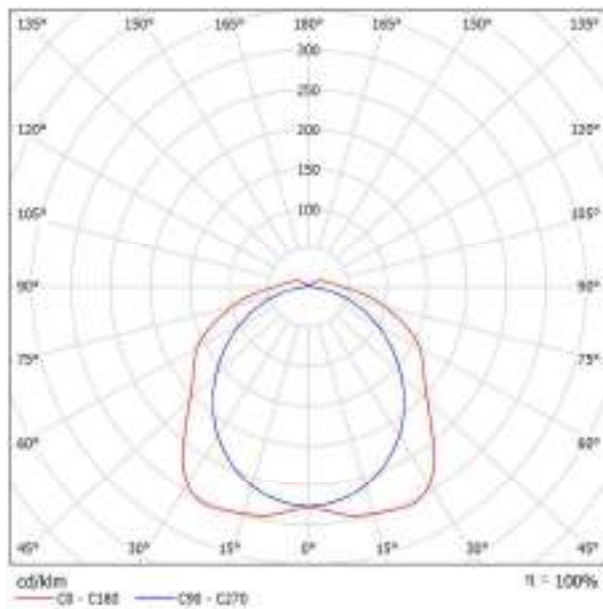

Classificazione lampade secondo CIE: 94
 CIE Flux Code: 44 74 91 94 100

Emissione luminosa 1:

L'alta esperienza tecnologica raggiunta dal Gruppo Disano nella progettazione illuminotecnica e nella produzione industriale ha reso possibile la realizzazione della nuova armatura stagna a LED. New Hydro LED è caratterizzata da una linea moderna che ben si integra in qualsiasi tipo di ambientazione. Corpo: Stampato ad iniezione, in policarbonato grigio, infrangibile, di elevata resistenza meccanica grazie alla struttura rinforzata da nervature interne. Diffusore: stampato ad iniezione in policarbonato con righe interne per un maggior controllo luminoso, autoestinguente V2, stabilizzato ai raggi UV, finitura esterna liscia per facilitare la pulizia necessaria per avere la massima efficienza luminosa. Chiusura a incastro e con viti di sicurezza in acciaio inox. Riflettore: in acciaio zincato preverniciato bianco a forno con resina poliestere stabilizzato ai raggi UV. Fissato al corpo con innesto rapido mediante dispositivo ricavato direttamente sul corpo. Dimensioni: L 1260mm - 102mm - 120mm Cablaggio: cavetto rigido sezione 0.5 mmq. Guaina di PVC_HT resistente a 90° C. secondo le norme EN 50525-2-31. Dotazione: guarnizione di tenuta iniettata in materiale ecologico di poliuretano espanso antinvecchiamento. Staffe di fissaggio a plafone e a sospensione in Acciaio Inox. Connettore presa-spina. L'ancoraggio dell'apparecchiatura sulle staffe di fissaggio avviene in sicurezza mediante innesto rapido. Normative: in conformità alla norma EN60598-1, EN60598-2-1. Grado di protezione: secondo la norma EN60598-1. Fattore di potenza: >= 0,95 Mantenimento flusso luminoso: L80B20 80.000h. Il prodotto risponde alla normativa americana Premium LED L90 – 36.000h Classificazione rischio fotobiologico: Gruppo esente; Low Flicker Risk Temperatura ambiente: -30°C a + 40°C Temperatura ambiente EM: +5°C a + 40°C A richiesta (con sovrapprezzo): radar sensor per armature ON-OFF: sottocodice -19 (con impostazione predefinita); armatura con cablaggio passante per fila continua: sottocodice -0072; armatura con cablaggio dimmerabile 1-10V + emergenza: sottocodice -94; armatura con cablaggio in emergenza ad alimentazione centralizzata: sottocodice -0050. Nelle installazioni con esposizione diretta ai raggi solari, si consiglia di utilizzare l'articolo Forma LED. L'apparecchio di illuminazione rispetta i requisiti previsti dai consorzi IFS e BRC, Direttiva HACCP, per gli impianti illuminotecnici nelle industrie alimentari. In ogni caso, verificare con i progettisti e con l'ufficio di consulenza Disano la compatibilità tra il materiale e gli alimenti, ed in tutte quelle industrie in cui è presente l'impianto di sanificazione.

Valutazione di abbagliamento secondo UGR										
α	Surfita	70	75	80	85	90	95	100	105	110
β	Diplay	80	85	90	95	100	105	110	115	120
γ	Perimetro	20	25	30	35	40	45	50	55	60
2m	2H	23,4	23,7	23,8	24,1	24,4	23,8	23,3	23,4	23,8
	3H	24,7	25,5	25,1	26,2	26,8	22,2	23,9	22,7	23,8
	4H	25,8	26,9	26,2	27,3	27,7	22,7	23,8	23,2	24,2
	5H	26,5	27,5	27,3	28,3	28,8	23,1	24,1	23,5	24,5
	6H	27,4	28,4	27,8	28,8	29,3	23,2	24,2	23,6	24,6
4m	2H	27,8	28,8	28,4	29,3	29,8	23,2	24,2	23,7	24,8
	3H	23,8	24,1	23,4	24,5	24,8	23,8	23,0	22,3	23,4
	4H	25,5	26,6	26,0	26,9	27,4	23,4	24,4	23,9	24,8
	5H	26,8	27,7	27,2	28,1	28,8	24,1	24,9	24,6	25,4
	6H	28,1	28,9	28,6	29,4	29,9	24,8	25,3	25,1	25,8
8m	2H	29,8	29,3	29,3	30,8	30,3	24,7	23,4	23,3	23,8
	3H	25,4	26,8	26,8	30,6	31,1	24,5	23,5	23,4	23,8
	4H	27,1	27,8	27,7	30,3	30,9	24,8	23,6	23,4	23,8
	5H	28,7	28,1	28,3	29,8	30,4	25,7	26,2	26,2	26,8
	6H	29,6	30,1	30,1	30,6	31,2	26,0	26,5	26,5	27,1
12m	2H	30,4	30,8	31,8	31,4	32,1	26,2	26,7	26,8	27,3
	3H	27,1	27,8	27,7	30,3	30,9	25,1	25,7	25,6	26,2
	4H	28,8	28,4	28,4	29,8	30,5	26,1	26,6	26,6	27,1
6H	29,8	30,2	30,4	30,8	31,4	26,9	27,8	27,1	27,8	

Valutazione delle posizioni differenziali per la distanza della lampada L		
S = 1,0h	+0,1 / -0,1	+0,1 / -0,1
S = 1,5h	+0,2 / -0,2	+0,2 / -0,2
S = 2,0h	+0,3 / -0,3	+0,4 / -0,3

Tabelle standard	
Adesso a	8,6
con	8,6

Valori di abbagliamento con i valori α e β in gradi e γ in metri

Redattore
 Telefono
 Fax
 e-Mail

Scena esterna 1 / Dati di pianificazione

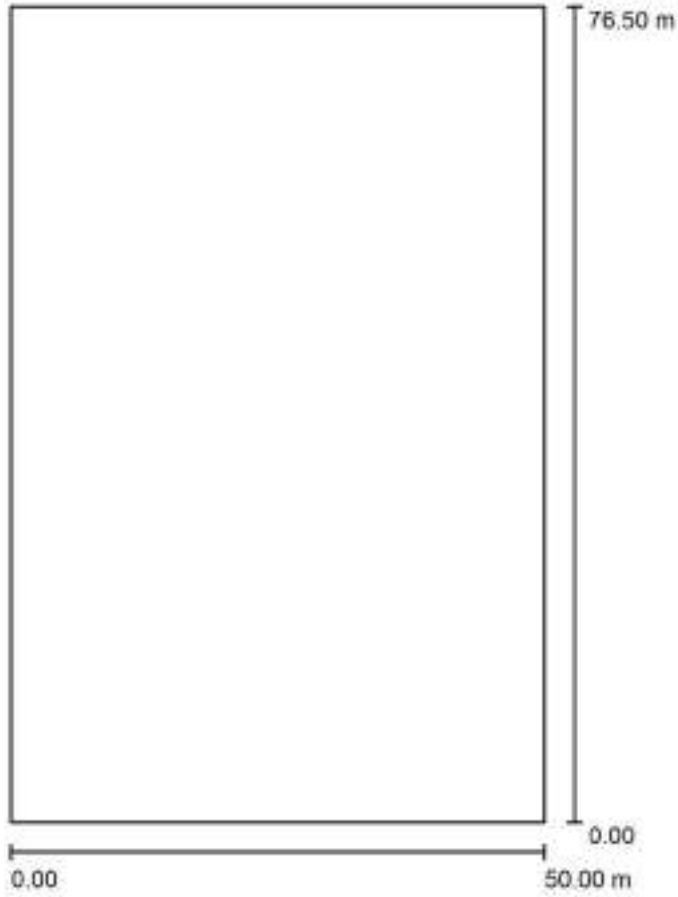

Fattore di manutenzione: 0.80, ULR (Upward Light Ratio): 1.0%

Scala 1:710

Distinta lampade

No.	Pezzo	Denominazione (Fattore di correzione)	Φ (Lampada) [lm]	Φ (Lampadine) [lm]	P [W]
1	18	Disano Illuminazione SpA 963 44w CLD CELL 963 - Hydro LED - High performance (1.000)	7766	7766	47.5
Totale:			139784	139788	855.0

Redattore
Telefono
Fax
e-Mail

Scena esterna 1 / Lista pezzi lampade

18 Pezzo Disano Illuminazione SpA 963 44w CLD CELL 963 -
Hydro LED - High performance
Articolo No.: 963 44w CLD CELL
Flusso luminoso (Lampada): 7766 lm
Flusso luminoso (Lampadine): 7766 lm
Potenza lampade: 47.5 W
Classificazione lampade secondo CIE: 94
CIE Flux Code: 44 74 91 94 100
Dotazione: 1 x led_44w_963 (Fattore di correzione
1.000).

Per un'immagine della
lampada consultare il
nostro catalogo lampade.



Redattore
 Telefono
 Fax
 e-Mail

Scena esterna 1 / Griglia di calcolo 1 / Riepilogo

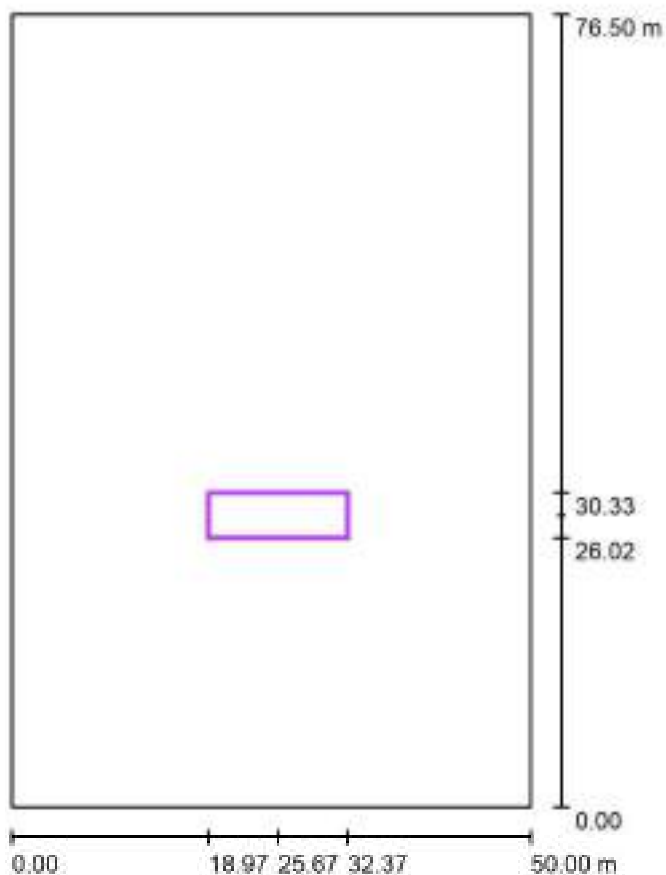

Scala 1 : 730

Posizione: (25.669 m, 28.176 m, 0.000 m)
 Dimensioni: (13.400 m, 4.306 m)
 Rotazione: (0.0°, 0.0°, 0.0°)
 Tipo: Normale, Reticolo: 11 x 5 Punti

Panoramica risultati

No.	Tipo	E_m [lx]	E_{min} [lx]	E_{max} [lx]	E_{min} / E_m	E_{min} / E_{max}	$E_{h\ m} / E_m$	H [m]	Fotocamera
1	perpendicolare	138	115	160	0.83	0.72	/	0.000	/

$E_{h\ m} / E_m$ = Rapporto tra illuminamento centrale orizzontale e verticale, H = Altezza di misurazione

Redattore
 Telefono
 Fax
 e-Mail

Scena esterna 1 / Griglia di calcolo 1 / Isolinee (E, perpendicolare)

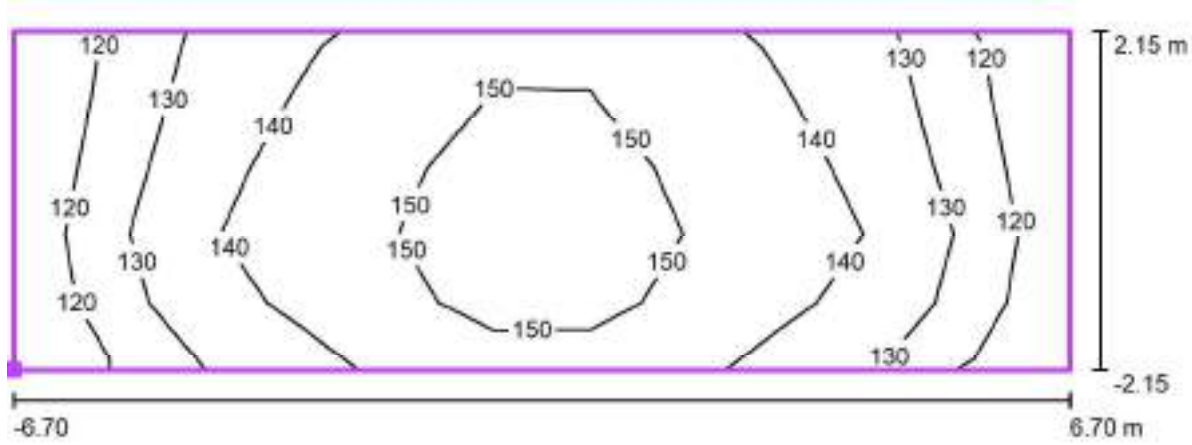

Valori in Lux, Scala 1 : 96

Posizione della superficie nella scena esterna:

Punto contrassegnato: (18.969 m, 26.023 m, 0.000 m)

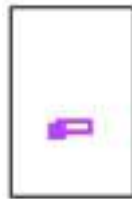

Reticolo: 11 x 5 Punti

E_m [lx]
138

E_{min} [lx]
115

E_{max} [lx]
160

E_{min} / E_m
0.83

E_{min} / E_{max}
0.72

Redattore
 Telefono
 Fax
 e-Mail

Scena esterna 1 / Griglia di calcolo 1 / Grafica dei valori (E, perpendicolare)

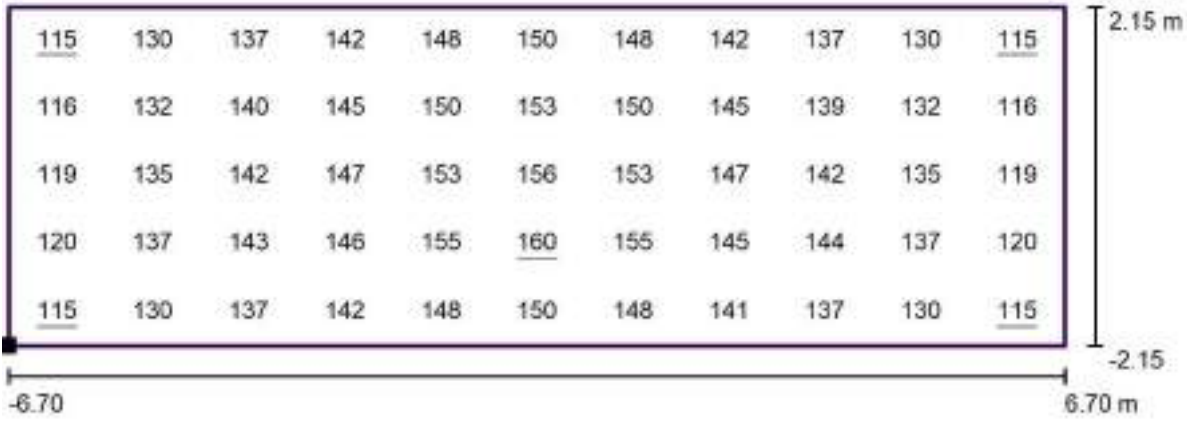

Valori in Lux, Scala 1 : 96

Posizione della superficie nella scena esterna:
 Punto contrassegnato: (18.969 m, 26.023 m, 0.000 m)

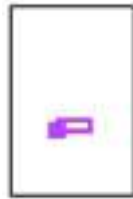

Reticolo: 11 x 5 Punti

E_m [lx]
138

E_{min} [lx]
115

E_{max} [lx]
160

E_{min} / E_m
0.83

E_{min} / E_{max}
0.72

3480 - Mini Giovi - high performance - grandi aree

Codice: 331051-39

INFORMAZIONI GENERALI



Articolo	3480 - Mini Giovi - high performance - grandi aree
Codice	331051-39

DIMENSIONI E PESO

Lunghezza (mm)	559 mm
Larghezza (mm)	293 mm
Altezza (mm)	115 mm
Peso (Kg)	6.5 kg

INSTALLAZIONE

Superficie di esposizione al vento (mm)	L 495 mm ² , F 1551 mm ²
-----------------------------------------	------------------------------------------------

CARATTERISTICHE ELETTRICHE E CONTROLLI

Tensione (V)	230 V
Frequenza (Hz)	50 Hz
Cablaggio	CLD
Fattore di potenza	≥0.9
Corrente(mA)	700 mA
Surge protector (differenziale/comune) (EN 61547)	6 kV, 10 kV
Classe di isolamento	Classe II



Mini Giovi rappresenta l'ultima generazione di apparecchi per l'illuminazione stradale a LED, progettati per le nuove sorgenti luminose e per i più recenti sistemi di gestione e controllo della luce.

Il suo corpo in alluminio pressofuso, il cui basso profilo riduce al minimo la resistenza al vento, è dotato di alette di raffreddamento appositamente studiate per una dissipazione del calore che permette il funzionamento ottimale dei LED.



3480 - Mini Giovi - high performance - grandi aree

Codice: 331051-39

DATI FOTOMETRICI

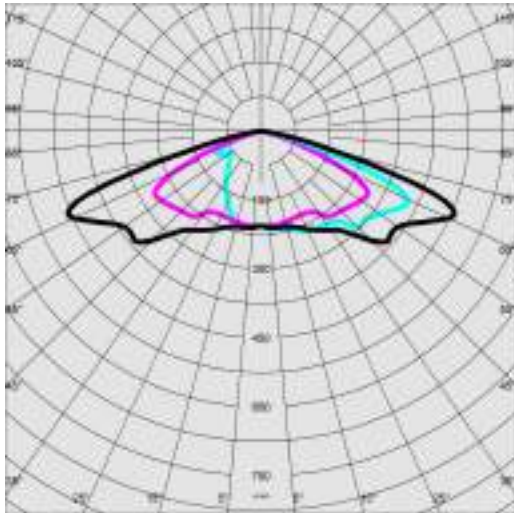

Tipo distribuzione	Medio / Comfort
Sorgente luminosa	LED
CRI	70
Flusso luminoso (uscente) (lm)	8759 lm
Potenza assorbita (totale) (W)	68 W
Efficienza luminosa (lm/W)	129 lm/W
Low Flicker	apparecchio con Flicker molto contenuto: luce uniforme per una maggior sicurezza visiva.
Mantenimento del flusso luminoso LED	100000 hr, L 90, B 10

CARATTERISTICHE MECCANICHE

Resistenza meccanica agli urti (IK)	IK09
IP	66



3480 - Mini Giovi - high performance - grandi aree

Codice: 331051-39

MATERIALI E COLORI

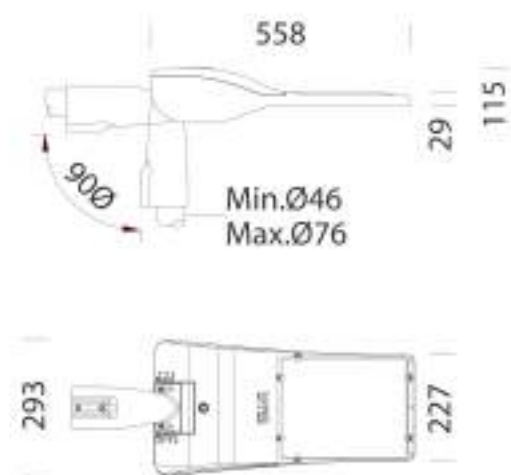

DOWNLOAD

MONTAGGI

IstruzioniMontaggio giovi - minigiovi 09-22.pdf

DISEGNI

BIM 3480 Mini Giovi - high performance - large areas - 20210903.zip

DisegnoTecnico minigiovi.dxf



Corpo	in alluminio pressofuso Lega EN-AB 47100 disegnato con una sezione a bassissima superficie di esposizione al vento. Alette di raffreddamento integrate nella copertura. Il coperchio permette, una volta rimosso di accedere al vano accessori elettrici.
Ottica	in PMMA ad alto rendimento resistente alle alte temperature e ai raggi UV.
Diffusore	vetro extra-chiaro sp. 4mm temperato resistente agli shock termici e agli urti (UNI-EN 12150-1:2001).
Dissipatore	il sistema di dissipazione del calore è appositamente studiato e realizzato per permettere il funzionamento dei LED con temperature idonee per garantire ottime prestazioni/rendimento ed un' elevata durata di vita.
Attacco palo	in alluminio pressofuso idoneo per pali di diametro da min.46mm a max.76mm orientabile da -20° a +10° per applicazione a frusta, e da 0° a +20° per applicazione a testa palo. Passo di inclinazione 5°.
Verniciatura	fase di pretrattamento superficiale del metallo, verniciatura con polvere poliestere, resistente alla corrosione, alle nebbie saline, stabilizzata ai raggi UV.
Verniciatura speciale (A RICHIESTA)	a richiesta: verniciatura conforme alla norma UNI EN ISO 9227, test di corrosione in atmosfera artificiale per ambienti aggressivi o marini (fronte mare).
Colore	Grafite
Equipaggiamento	<ul style="list-style-type: none">- connettore rapido IP67.- valvola anticondensa.- dispositivo di controllo della temperatura con ripristino automatico.- dispositivo di protezione conforme alla EN 61547 contro i fenomeni impulsivi.- funzioni integrate ADVANCED PROG.

NORME E CONFORMITÀ

Classe sicurezza fotobio-logica	RG0 Ethr
Marcature e test	CE, ENEC, ENEC+, ZHAGA D4i
Norme di riferimento	EN60598-1. Hanno grado di protezione secondo la norma EN60529. Registered Design DM/100271.

DOTAZIONI

A richiesta	funzione luce costante (CLO); idoneità al funzionamento in emergenza.
-------------	-----------------------------------------------------------------------

GARANZIA

Garanzia post-vendita	5 yr
-----------------------	------

3480 - Mini Giovi - high performance - grandi aree

Codice: 331051-39

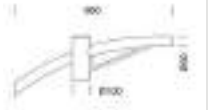

504 Braccio singolo



508 Braccio doppio



1491 Palo da interrare



1493 Palo con base



1477 Palo Urban - con base



1478 Palo Urban da interrare



1508 Palo rigato \varnothing 120 con base



1509 Palo rigato \varnothing 120

1887 - Rodio LED - asimmetrico

Codice: 414752-39

INFORMAZIONI GENERALI



Tanti modelli diversi, con potenze e ottiche differenziate per un risultato sempre di ottima qualità. Sono gli apparecchi ideali per illuminare facciate e completare l'illuminazione stradale, negli impianti sportivi, in ambito residenziale e, in generale, nell'illuminazione da esterni.

La famiglia Rodio comprende diverse versioni, con ottiche asimmetriche, a fascio stretto e diffondente, disponibili anche nelle versioni con curva diffondente e stradale, con Midnight. Equipaggiati con Led di ultima generazione, questi apparecchi offrono un perfetto controllo della luce, senza abbagliamenti. Si possono scegliere versioni con lenti o con LED COB per migliori prestazioni luminose. In tutti i modelli la luce è di altissima qualità, con temperature di colore di 3000 o 4000K e ottima resa del colore. Disponibili anche in versione con temperatura di colore Ambra.



Articolo	1887 - Rodio LED - asimmetrico
Codice	414752-39

DIMENSIONI E PESO

Lunghezza (mm)	568 mm
Larghezza (mm)	333 mm
Altezza (mm)	85 mm
Peso (Kg)	5.81 kg

INSTALLAZIONE

Superficie di esposizione al vento (mm)	L 390 mm ² , F 1420 mm ²
-----------------------------------------	------------------------------------------------

CARATTERISTICHE ELETTRICHE E CONTROLLI

Tensione (V)	230 V
Frequenza (Hz)	50 Hz
Cablaggio	CLD
Fattore di potenza	≥0.9
Surge protector (differenziale/comune) (EN 61547)	6 kV, 8 kV
Classe di isolamento	Classe II

1887 - Rodio LED - asimmetrico

Codice: 414752-39

DATI FOTOMETRICI

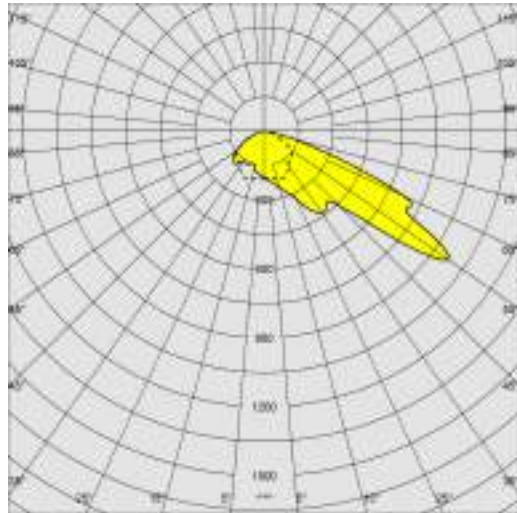

Tipo distribuzione	Asimmetrico
Sorgente luminosa	LED
CRI	80
Flusso luminoso (uscente) (lm)	15942 lm
Potenza assorbita (totale) (W)	118 W
Efficienza luminosa (lm/W)	135 lm/W
Low Flicker	apparecchio con Flicker molto contenuto: luce uniforme per una maggior sicurezza visiva.
Angolo fascio luminoso (°)	55 °
Mantenimento del flusso luminoso LED	80000 hr, L 80, B 20

CARATTERISTICHE MECCANICHE

Resistenza meccanica agli urti (IK)	IK08
IP	66



1887 - Rodio LED - asimmetrico

Codice: 414752-39

MATERIALI E COLORI

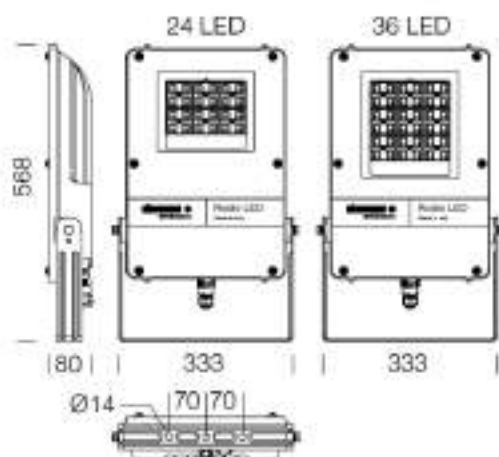

DOWNLOAD

MONTAGGI

IstruzioniMontaggio rodio 09-22.pdf

DISEGNI

BIM 1887 Rodio LED - asymmetric - 20200528.zip

DisegnoTecnico 1887i.dxf

DisegnoTecnico3D disano 1887 rodio 36 led.3ds



Corpo	in alluminio pressofuso con alette di raffreddamento integrate nella copertura.
Ottica	in PMMA ad alto rendimento resistente alle alte temperature e ai raggi UV.
Diffusore	vetro temperato sp. 5mm, resistente agli shock termici e agli urti (UNI EN 12150-1:2001).
Dissipatore	il sistema di dissipazione del calore è appositamente studiato e realizzato per permettere il funzionamento dei LED con temperature idonee per garantire ottime prestazioni/rendimento ed un' elevata durata di vita.
Verniciatura	fase di pretrattamento superficiale del metallo, verniciatura con polvere poliesteri, resistente alla corrosione, alle nebbie saline, stabilizzata ai raggi UV.
Verniciatura speciale (A RICHIESTA)	-verniciatura conforme UNI EN ISO 9227 (Test di corrosione in atmosfera artificiale per ambienti aggressivi) -trattamento di conformal coating sottocodice -38 ad elevata resistenza chimica per ambienti con un alta concentrazione di cloro
Colore	Grafite
Equipaggiamento	-completo di staffa zincata e verniciata -connettore rapido IP68 -dispositivo di protezione conforme EN 61547 contro i fenomeni impulsivi -valvola anticondensa -guarnizione in gomma siliconica -viterie esterne in acc.inox

NORME E CONFORMITÀ

Classe sicurezza fotobiologica	RG0 Ethr
Marcature e test	CE, ENEC
Norme di riferimento	EN60598-1. Hanno grado di protezione secondo la norma EN60529.

DOTAZIONI

A richiesta	- protezione fino a 10KV. - Mezzanotte virtuale (sottocodice -30) - led ambra (sottocodice -73 - 2200K) - possibilità di gestione del punto-luce centralizzata o con sensori di presenza/luminosità esterni.
-------------	-----------------------------------------------------------------------------------------------------------------------------------------------------------------------------------------------------------------------

GARANZIA

Garanzia post-vendita	5 yr
-----------------------	------

1887 - Rodio LED - asimmetrico

Codice: 414752-39



334 Attacco palo diam. 76



350 Gabbia di protezione - Rodio



333 Attacco palo diam.60

1892 - Rodio LED - ottica stradale

Codice: 414776-39

INFORMAZIONI GENERALI



Articolo	1892 - Rodio LED - ottica stradale
Codice	414776-39

DIMENSIONI E PESO

Lunghezza (mm)	568 mm
Larghezza (mm)	333 mm
Altezza (mm)	85 mm
Peso (Kg)	5.91 kg

INSTALLAZIONE

Superficie di esposizione al vento (mm)	L 390 mm ² , F 1420 mm ²
-----------------------------------------	------------------------------------------------

CARATTERISTICHE ELETTRICHE E CONTROLLI

Tensione (V)	230 V
Frequenza (Hz)	50 Hz
Cablaggio	CLD
Fattore di potenza	≥0.9
Surge protector (differenziale/comune) (EN 61547)	6 kV, 8 kV
Classe di isolamento	Classe II



Tanti modelli diversi, con potenze e ottiche differenziate per un risultato sempre di ottima qualità. Sono gli apparecchi ideali per illuminare facciate e completare l'illuminazione stradale, negli impianti sportivi, in ambito residenziale e, in generale, nell'illuminazione da esterni.

La famiglia Rodio comprende diverse versioni, con ottiche asimmetriche, a fascio stretto e diffondente, disponibili anche nelle versioni con curva diffondente e stradale, con Midnight. Equipaggiati con Led di ultima generazione, questi apparecchi offrono un perfetto controllo della luce, senza abbagliamenti. Si possono scegliere versioni con lenti o con LED COB per migliori prestazioni luminose. In tutti i modelli la luce è di altissima qualità, con temperature di colore di 3000 o 4000K e ottima resa del colore. Disponibili anche in versione con temperatura di colore Ambra.



1892 - Rodio LED - ottica stradale

Codice: 414776-39

DATI FOTOMETRICI

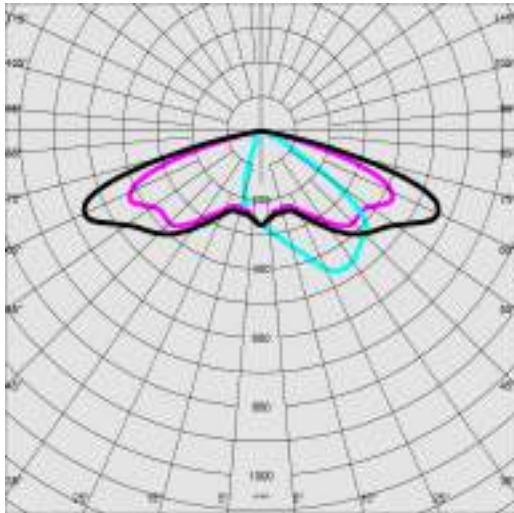

Sorgente luminosa	LED
CRI	80
Flusso luminoso (uscente) (lm)	14551 lm
Potenza assorbita (totale) (W)	118 W
Efficienza luminosa (lm/W)	123 lm/W
Low Flicker	apparecchio con Flicker molto contenuto: luce uniforme per una maggior sicurezza visiva.
Mantenimento del flusso luminoso LED	80000 hr, L 80, B 20

CARATTERISTICHE MECCANICHE

Resistenza meccanica agli urti (IK)	IK08
IP	66



1892 - Rodio LED - ottica stradale

Codice: 414776-39

MATERIALI E COLORI

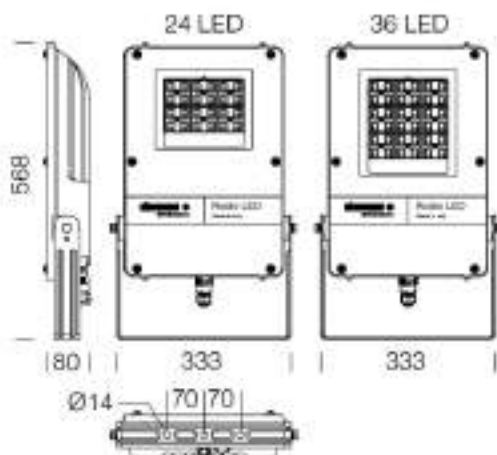

DOWNLOAD

MONTAGGI

IstruzioniMontaggio rodio 09-22.pdf

DISEGNI

BIM 1892 Rodio LED - street type - 20200528.zip

DisegnoTecnico 1892i.dxf

DisegnoTecnico3D disano 1892 rodio.3ds



Corpo	in alluminio pressofuso con alette di raffreddamento integrate nella copertura.
Ottica	in PMMA ad alto rendimento resistente alle alte temperature e ai raggi UV.
Diffusore	vetro temperato sp. 5mm, resistente agli shock termici e agli urti (UNI EN 12150-1:2001).
Dissipatore	il sistema di dissipazione del calore è appositamente studiato e realizzato per permettere il funzionamento dei LED con temperature idonee per garantire ottime prestazioni/rendimento ed un' elevata durata di vita.
Verniciatura	fase di pretrattamento superficiale del metallo, verniciatura con polvere poliesteri, resistente alla corrosione, alle nebbie saline, stabilizzata ai raggi UV.
Verniciatura speciale (A RICHIESTA)	a richiesta: verniciatura conforme alla norma UNI EN ISO 9227, test di corrosione in atmosfera artificiale per ambienti aggressivi o marini (fronte mare).
Colore	Grafite
Equipaggiamento	-completo di staffa zincata e verniciata -connettore rapido IP68 -dispositivo di protezione conforme EN 61547 contro i fenomeni impulsivi -valvola anticondensa -guarnizione in gomma silconica -viterie esterne in acc.inox

NORME E CONFORMITÀ

Classe sicurezza fotobiologica	RG0 Ethr
Marche e test	CE, ENEC
Norme di riferimento	EN60598-1. Hanno grado di protezione secondo la norma EN60529.

DOTAZIONI

A richiesta	- protezione fino a 10KV. - Mezzanotte virtuale (sottocodice -30) - led ambrati (sottocodice -73 - 2200K) - possibilità di gestione del punto-luce centralizzata o con sensori di presenza/luminosità esterni.
-------------	-------------------------------------------------------------------------------------------------------------------------------------------------------------------------------------------------------------------------

GARANZIA

Garanzia post-vendita	5 yr
-----------------------	------

1892 - Rodio LED - ottica stradale

Codice: 414776-39



333 Attacco palo diam.60



334 Attacco palo diam. 76



350 Gabbia di protezione - Rodio

1980 - Micro Rodio - COB

Codice: 414860-39

INFORMAZIONI GENERALI



Articolo	1980 - Micro Rodio - COB
Codice	414860-39

DIMENSIONI E PESO

Lunghezza (mm)	145 mm
Larghezza (mm)	45 mm
Altezza (mm)	227 mm
Peso (Kg)	1.11 kg

INSTALLAZIONE

Superficie di esposizione al vento (mm)	L 86 mm ² , F 278 mm ²
-----------------------------------------	----------------------------------------------

CARATTERISTICHE ELETTRICHE E CONTROLLI

Tensione (V)	230 V
Frequenza (Hz)	50 Hz
Cablaggio	CLD
Fattore di potenza	≥0.9
Surge protector (di-ziale/comune) (EN 61547)	1 kV, 2 kV
Classe di isolamento	Classe I



Per risolvere al meglio anche i progetti di luce dove la dimensione dell'apparecchio può fare la differenza. Disano presenta Micro Rodio, il proiettore che concentra in dimensioni estremamente contenute tutta la tecnologia della famiglia Rodio. Disponibile anche in versione con LED COB, per avere una maggiore qualità della luce, si distingue per la lunga durata di vita, garantita dalla qualità dei materiali e delle sorgenti LED.



1980 - Micro Rodio - COB

Codice: 414860-39

DATI FOTOMETRICI

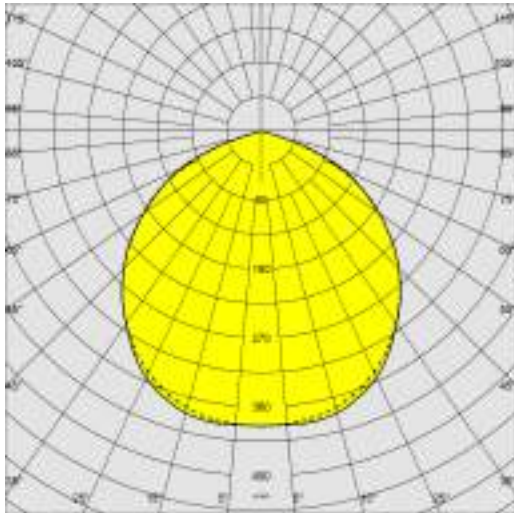

Sorgente luminosa	LED COB
CRI	90
Flusso luminoso (uscente) (lm)	2309 lm
Potenza assorbita (totale) (W)	29 W
Efficienza luminosa (lm/W)	80 lm/W
Low Flicker	apparecchio con Flicker molto contenuto: luce uniforme per una maggior sicurezza visiva.
Mantenimento del flusso luminoso LED	50000 hr, L 80, B 20

CARATTERISTICHE MECCANICHE

Resistenza meccanica agli urti (IK)	IK08
IP	66



1980 - Micro Rodio - COB

Codice: 414860-39

MATERIALI E COLORI

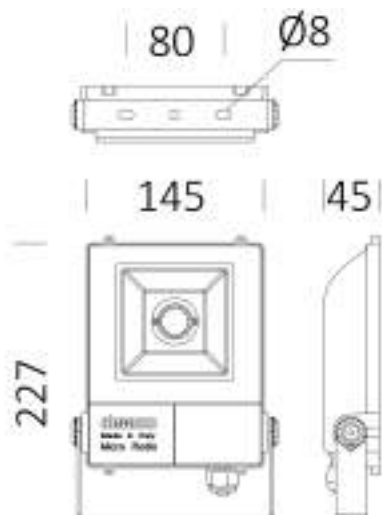

DOWNLOAD

MONTAGGI

IstruzioniMontaggio microrodio 09-22.pdf

DISEGNI

BIM 1980 Micro Rodio - COB - 20200528.zip

DisegnoTecnico 1980.dxf

DisegnoTecnico3D disano 1980 microrodio.3ds



Corpo	in alluminio pressofuso con alette di raffreddamento integrate nella copertura.
Ottica	in alluminio prismaticizzato e brillantato ad alto rendimento
Diffusore	vetro temperato sp. 4mm, resistente agli shock termici e agli urti (UNI EN 12150-1:2001).
Dissipatore	il sistema di dissipazione del calore è appositamente studiato e realizzato per permettere il funzionamento dei LED con temperature idonee per garantire ottime prestazioni/rendimento ed un' elevata durata di vita.
Verniciatura	fase di pretrattamento superficiale del metallo, verniciatura con polvere poliestere, resistente alla corrosione, alle nebbie saline, stabilizzata ai raggi UV.
Verniciatura speciale (A RICHIESTA)	a richiesta: verniciatura conforme alla norma UNI EN ISO 9227, test di corrosione in atmosfera artificiale per ambienti aggressivi o marini (fronte mare).
Colore	Grafite
Equipaggiamento	-completo di staffa zincata e verniciata. -cavo per il collegamento elettrico. -dispositivo di protezione conforme EN 61547 contro i fenomeni impulsivi. -guarnizione in gomma siliconica. -viterie esterne in acc.inox.

NORME E CONFORMITÀ

Classe sicurezza fotobiologica	RG0 Ethr
Marcature e test	CE
Norme di riferimento	EN60598-1. Hanno grado di protezione secondo la norma EN60529. Registered Design DM/100271.

DOTAZIONI

A richiesta	- versione con sensore di presenza (sottocodice -19) - doppio isolamento con (sottocodice -14) - cablaggio CLD-D-D (DALI) (sottocodice -0041)
-------------	-----------------------------------------------------------------------------------------------------------------------------------------------------

GARANZIA

Garanzia post-vendita	5 yr
-----------------------	------

1980 - Micro Rodio - COB

Codice: 414860-39

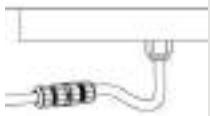

339 Connettore



41 Braccio orientabile

963 Hydro LED - High Performance



L'alta esperienza tecnologica raggiunta dal Gruppo Disano nella progettazione illuminotecnica e nella produzione industriale ha reso possibile la realizzazione della nuova armatura stagna a LED. New Hydro LED è caratterizzata da una linea moderna che ben si integra in qualsiasi tipo di ambientazione.

Corpo: Stampato ad iniezione, in polycarbonato grigio, infrangibile, di elevata resistenza meccanica grazie alla struttura rinforzata da nervature interne. Diffusore: stampato ad iniezione in polycarbonato con righe interne per un maggior controllo luminoso, autoestinguento V2, stabilizzato ai raggi UV, finitura esterna liscia per facilitare la pulizia necessaria per avere la massima efficienza luminosa. Chiusura a incastro e con viti di sicurezza in acciaio inox. Riflettore: in acciaio zincato preverniciato bianco a forno con resina poliestere stabilizzato ai raggi UV. Fissato al corpo con innesto rapido mediante dispositivo ricavato direttamente sul corpo.

Dimensioni: L 1260mm - 102mm - 55mm Cablaggio: cavetto rigido sezione 0.5 mmq. Guaina di PVC-HT resistente a 90° C. secondo le norme EN 50525-2-31. Dotazione: guarnizione di tenuta iniettata in materiale ecologico di poliuretano espanso antinvecchiamento. Staffe di fissaggio a plafone e a sospensione in Acciaio Inox. Connettore presa-spina. L'ancoraggio dell'apparecchiatura sulle staffe di fissaggio avviene in sicurezza mediante innesto rapido. Normative: in conformità alla norma EN60598-1, EN60598-2-1. Grado di protezione: secondo la norma EN60598-1.

Fattore di potenza: $\geq 0,95$ Mantenimento flusso luminoso: L80B20 80.000h. Il prodotto risponde alla normativa americana Premium LED L90 - 36.000h. Classificazione rischio fotobiologico: Gruppo esente Low Flicker Risk Temperatura ambiente: -30°C a + 40°C Temperatura ambiente EM: +5°C a + 40°C

A richiesta (con sovrapprezzo): • radar sensor per armature ON-OFF: sottocodice -19 (con impostazione predefinita); • armatura con cablaggio passante per fila continua: sottocodice -0072; • armatura con cablaggio dimmerabile 1-10V + emergenza: sottocodice -94; • armatura con cablaggio in emergenza ad alimentazione centralizzata: sottocodice -0050. Nelle installazioni con esposizione diretta ai raggi solari, si consiglia di utilizzare l'articolo Forma LED.

L'apparecchio di illuminazione rispetta i requisiti previsti dai consorzi IFS e BRC, Direttiva HACCP, per gli impianti illuminotecnici nelle industrie alimentari. In ogni caso, verificare con i progettisti e con l'ufficio di consulenza Disano la compatibilità tra il materiale e gli alimenti, ed in tutte quelle industrie in cui è presente l'impianto di sanificazione.

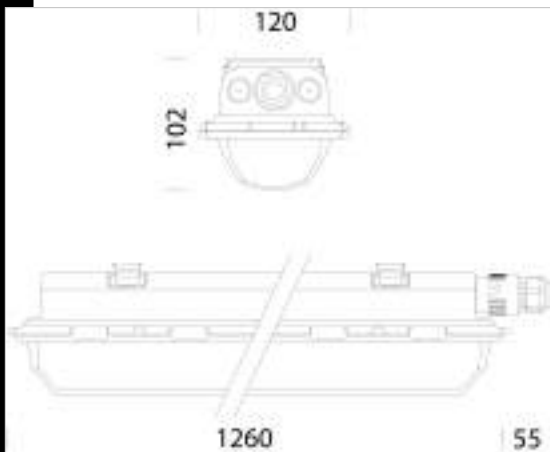

Codice	Cablaggio	Kg	Lumen-K-CRI	WTot	Colore
164762-00	CLD	2.36	LED-3028lm-4000K-CRI>80	20 W	GRIGIO
164762-07	CLD-E	2.42	LED-3028lm-4000K-CRI>80	23 W	GRIGIO
164763-00	CLD	2.36	LED-3749lm-4000K-CRI>80	27 W	GRIGIO
164763-07	CLD-E	2.38	LED-3749lm-4000K-CRI>80	30 W	GRIGIO
164764-00	CLD	2.36	LED-5547lm-4000K-CRI>80	34 W	GRIGIO
164764-07	CLD-E	2.38	LED-5547lm-4000K-CRI>80	37 W	GRIGIO
164765-00	CLD	1.89	LED-7766lm-4000K-CRI>80	47 W	GRIGIO
164764-0041	CLD-D-D	1.93	LED-5547lm-4000K-CRI>80	34 W	GRIGIO
164764-12	CLD-D	1.93	LED-5547lm-4000K-CRI>80	34 W	GRIGIO
164765-07	CLD-E	2.35	LED-7766lm-4000K-CRI>80	50 W	GRIGIO
164765-12	CLD-D	2.04	LED-7766lm-4000K-CRI>80	47 W	GRIGIO
164765-0041	CLD-D-D	1.86	LED-7766lm-4000K-CRI>80	47 W	GRIGIO
164766-00	CLD	1.89	LED-9020lm-4000K-CRI80	56 W	GRIGIO
164766-07	CLD-E	2.38	LED-9020lm-4000K-CRI80	56 W	GRIGIO
164766-0041	CLD-D-D	1.99	LED-9020lm-4000K-CRI80	56 W	GRIGIO



Download

DXF 2D
- 962.dxf

Montaggi
- hydro-thema 10-21.pdf
- hydro-thema EM-continuous 09-21.pdf

Il flusso luminoso riportato indica il flusso uscente dall'apparecchio con una tolleranza di $\pm 10\%$ rispetto al valore indicato. I W tot sono la potenza totale assorbita dal sistema e non supera il 10% del valore indicato.



illuminazione

DISANO Illuminazione S.p.A.

v.le Lombardia 129, ROZZANO (MI)

Tel. +39 02824771 - Fax +39 028252355

Email: info@disano.it

Dichiarazione di Conformità

Alla Legge Regionale Veneto n.17 del 7 agosto 2009

La ditta: **DISANO ILLUMINAZIONE S.P.A.**

dichiara sotto la propria responsabilità che il prodotto della serie o modello:

[ART. 1980 MICRO RODIO cod. 41486039]

Con lampade: **[LED]**

Laboratorio Accreditato:

Testato nel Laboratorio	Fotometrico DISANO ILLUMINAZIONE S.P.A.
Goniofotometro a specchio	Distanza di misura 14.185 m.
Responsabile Tecnico	Enzo Pappalardo

Norme di Riferimento:

UNI EN 13032-4:2015	Measurement and presentation of photometric data of lamps and luminaires
---------------------	--------------------------------------------------------------------------

Apparecchio:

Tipo di Riflettore	Asimmetrico	Tipo di Schermo	Vetro
Parametri di Misura		Temperatura Ambiente	25°
Tensione Alimentazione	230V	Frequenza	50 Hz

Da installare con vetro parallelo al suolo,

Utilizzati nel comune di Mestre (VE)

N° pezzi: 24 (41486039)

è Conforme alla LR n.17 del 07/08/ 2009 e successive modifiche di integrazione

in quanto l'apparecchio nella sua posizione di installazione presenta un'intensità luminosa massima per $\gamma \geq 90^\circ$, compresa tra 0,00 cd e 0,49 cd per 1000 lumen di flusso luminoso totale emesso ;

venerdì 5 maggio 2023

DISANO ILLUMINAZIONE S.P.A.

Disano Illuminazione S.p.A.
Centro Consulenza
Progettazione illuminotecnica
Email: enzo.pappalardo@disano.it

Enzo Pappalardo



illuminazione

DISANO Illuminazione S.p.A.

v.le Lombardia 129, ROZZANO (MI)

Tel. +39 02824771 - Fax +39 028252355

Email: info@disano.it

Dichiarazione di Conformità

Alla Legge Regionale Veneto n.17 del 7 agosto 2009

La ditta: **DISANO ILLUMINAZIONE S.P.A**

dichiara sotto la propria responsabilità che il prodotto della serie o modello:

[ART. 3480 – MINI GIOVI cod. 33105130]

Con lampade **[LED]**

Laboratorio Accreditato:

Testato nel Laboratorio	Fotometrico DISANO ILLUMINAZIONE S.P.A.
Goniofotometro a specchio	Distanza di misura 14.185 m.
Responsabile Tecnico	Enzo Pappalardo

Norme di Riferimento:

UNI EN 13032-4:2015	Measurement and presentation of photometric data of lamps and luminaires
---------------------	--------------------------------------------------------------------------

Apparecchio:

Tipo di Riflettore	Stradale	Tipo di Schermo	Vetro
Parametri di Misura		Temperatura Ambiente	25°
Tensione Alimentazione	230V	Frequenza	50 Hz

Da utilizzare con vetro parallelo al suolo,

Utilizzato nel comune di Mestre (VE)

N° pezzi: 30 (33105130)

è Conforme alla LR n.17 del 07/08/ 2009

in quanto l'apparecchio nella sua posizione di installazione presenta un'intensità luminosa massima per $\gamma \geq 90^\circ$, compresa tra 0,00 cd e 0,49 cd per 1000 lumen di flusso luminoso totale emesso ;

venerdì 5 maggio 2023

DISANO ILLUMINAZIONE S.P.A.

Disano Illuminazione S.p.A.
Centro Consulenza
Progettazione illuminotecnica
Email: enzo.pappalardo@disano.it

Enzo Pappalardo



DISANO Illuminazione S.p.A.

v.le Lombardia 129, ROZZANO (MI)
Tel. +39 02824771 - Fax +39 028252355
Email: info@disano.it

Dichiarazione di Conformità
Alla Legge Regionale Veneto n.17 del 7 agosto 2009

La ditta: **DISANO ILLUMINAZIONE S.P.A.**

dichiara sotto la propria responsabilità che il prodotto della serie o modello:

[ART. 1887 RODIO cod. 41475239 - 41475339]

Con lampade: **[LED]**

Laboratorio Accreditato:

Testato nel Laboratorio	Fotometrico DISANO ILLUMINAZIONE S.P.A.
Goniofotometro a specchio	Distanza di misura 14.185 m.
Responsabile Tecnico	Enzo Pappalardo

Norme di Riferimento:

UNI EN 13032-4:2015	Measurement and presentation of photometric data of lamps and luminaires
---------------------	--------------------------------------------------------------------------

Apparecchio:

Tipo di Riflettore	Asimmetrico	Tipo di Schermo	Vetro
Parametri di Misura		Temperatura Ambiente	25°
Tensione Alimentazione	230V	Frequenza	50 Hz

Da installare con vetro parallelo al suolo,

Utilizzati nel comune di Mestre (VE)

N° pezzi: 13 (41475239) – 2 (41475339)

è Conforme alla LR n.17 del 07/08/ 2009 e successive modifiche di integrazione

in quanto l'apparecchio nella sua posizione di installazione presenta un'intensità luminosa massima per $\gamma \geq 90^\circ$, compresa tra 0,00 cd e 0,49 cd per 1000 lumen di flusso luminoso totale emesso ;

venerdì 5 maggio 2023
DISANO ILLUMINAZIONE S.P.A.

Disano Illuminazione S.p.A.
Centro Consulenza
Progettazione illuminotecnica
Email: enzo.pappalardo@disano.it

Enzo Pappalardo



illuminazione

DISANO Illuminazione S.p.A.

v.le Lombardia 129, ROZZANO (MI)

Tel. +39 02824771 - Fax +39 028252355

Email: info@disano.it

Dichiarazione di Conformità

Alla Legge Regionale Veneto n.17 del 7 agosto 2009

La ditta: **DISANO ILLUMINAZIONE S.P.A.**

dichiara sotto la propria responsabilità che il prodotto della serie o modello:

[ART. 1892 RODIO cod. 41477639]

Con lampade: **[LED]**

Laboratorio Accreditato:

Testato nel Laboratorio	Fotometrico DISANO ILLUMINAZIONE S.P.A.
Goniofotometro a specchio	Distanza di misura 14.185 m.
Responsabile Tecnico	Enzo Pappalardo

Norme di Riferimento:

UNI EN 13032-4:2015	Measurement and presentation of photometric data of lamps and luminaires
---------------------	--------------------------------------------------------------------------

Apparecchio:

Tipo di Riflettore	Stradale	Tipo di Schermo	Vetro
Parametri di Misura		Temperatura Ambiente	25°
Tensione Alimentazione	230V	Frequenza	50 Hz

Da installare con vetro parallelo al suolo,

Utilizzati nel comune di Mestre (VE)

N° pezzi: 14 (41477639)

è Conforme alla LR n.17 del 07/08/ 2009 e successive modifiche di integrazione





in quanto l'apparecchio nella sua posizione di installazione presenta un'intensità luminosa massima per $\gamma \geq 90^\circ$, compresa tra 0,00 cd e 0,49 cd per 1000 lumen di flusso luminoso totale emesso ;

venerdì 5 maggio 2023

DISANO ILLUMINAZIONE S.P.A.

Disano Illuminazione S.p.A.
Centro Consulenza
Progettazione illuminotecnica
Email: enzo.pappalardo@disano.it

Enzo Pappalardo

-  QUADRO ELETTRICO
-  CONTATORE ENEL
-  PUNTO LUCE TESTA PALO H 4m (vedi particolare)
-  PUNTO LUCE TESTA PALO H 5m (vedi particolare)
-  PUNTO LUCE TESTA PALO H 7m (vedi particolare)
-  PUNTO LUCE TESTA PALO H 11m (vedi particolare)
-  PUNTO DI SOSTEGNO PER PALI DI ILLUMINAZIONE CON POZZETTO INCORPORATO PER ILLUMINAZIONE STRADALE
-  TUBAZIONE IN PVC CORRUGATO DOPPIA PARETE Ø110

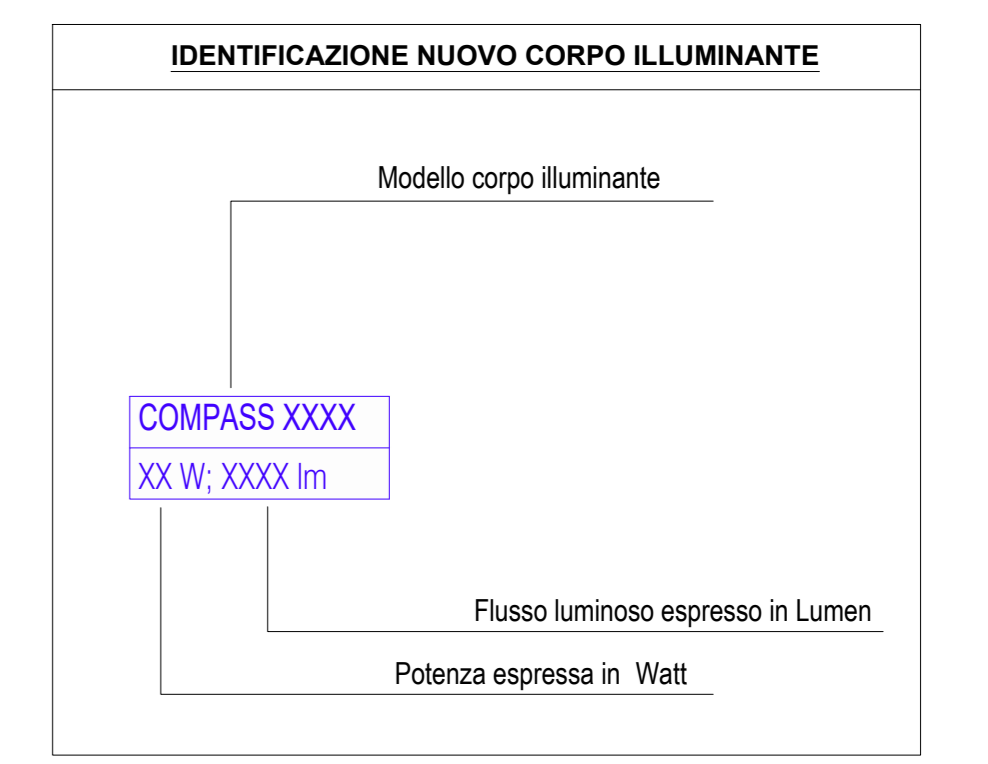
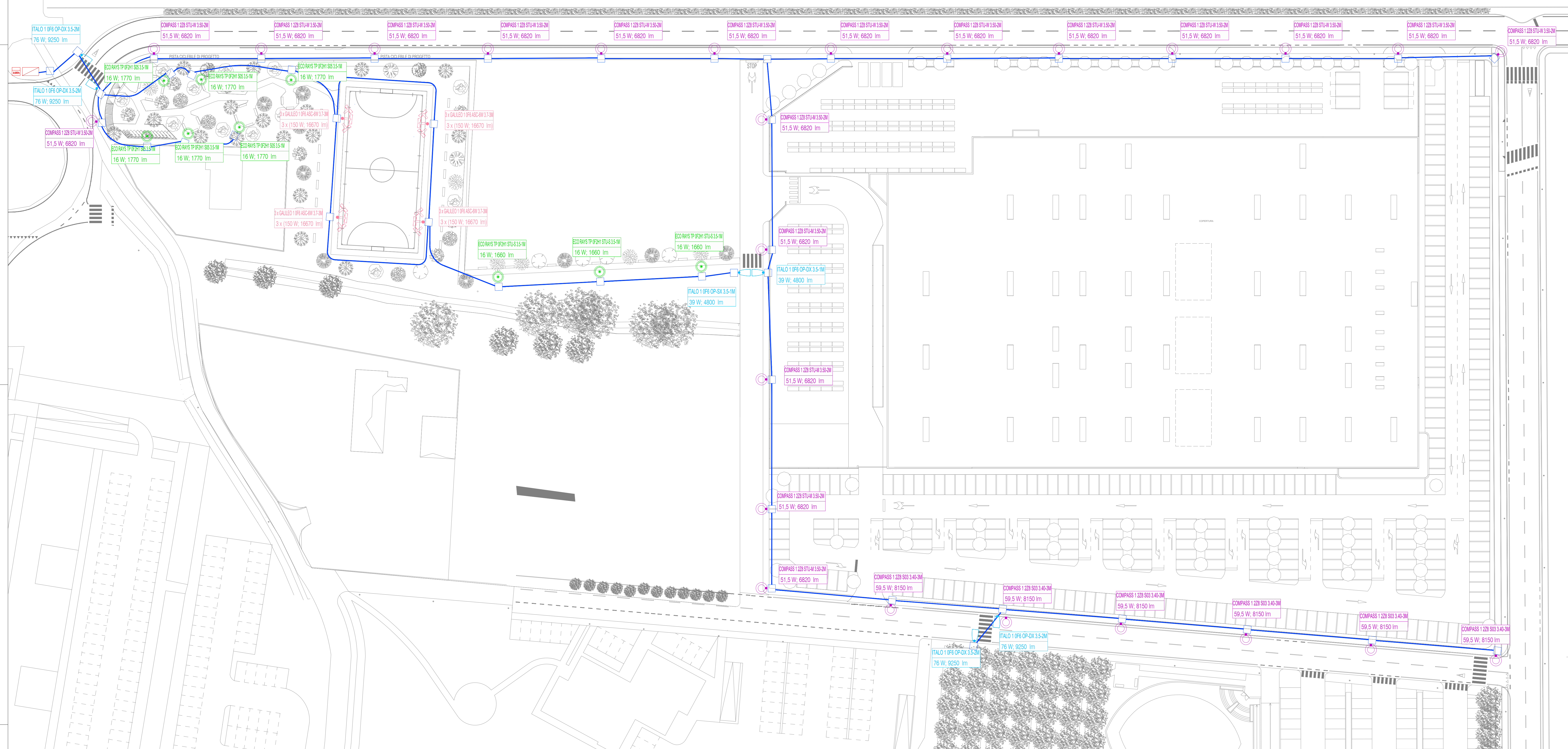

ESTERNI
SCALA 1:400

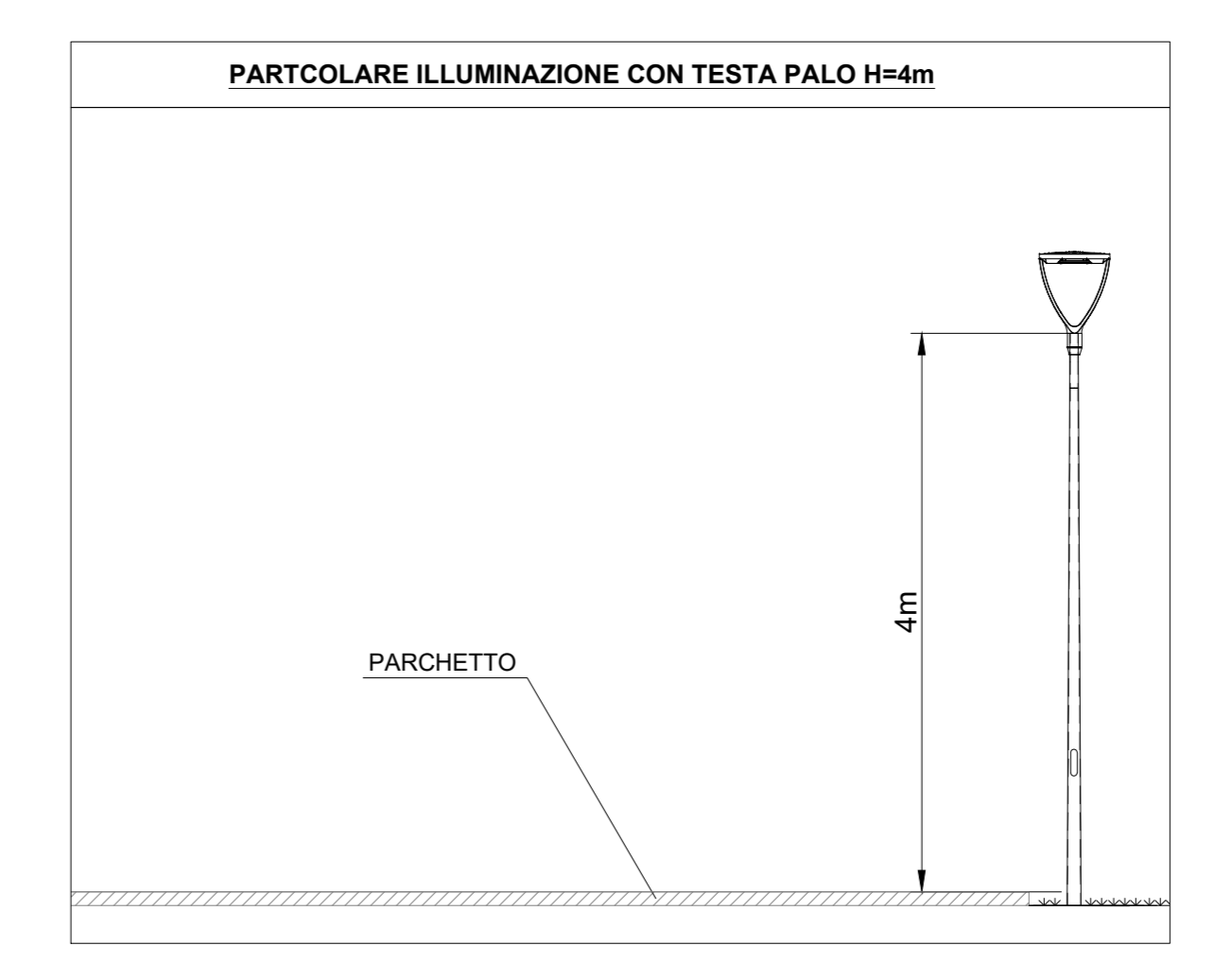
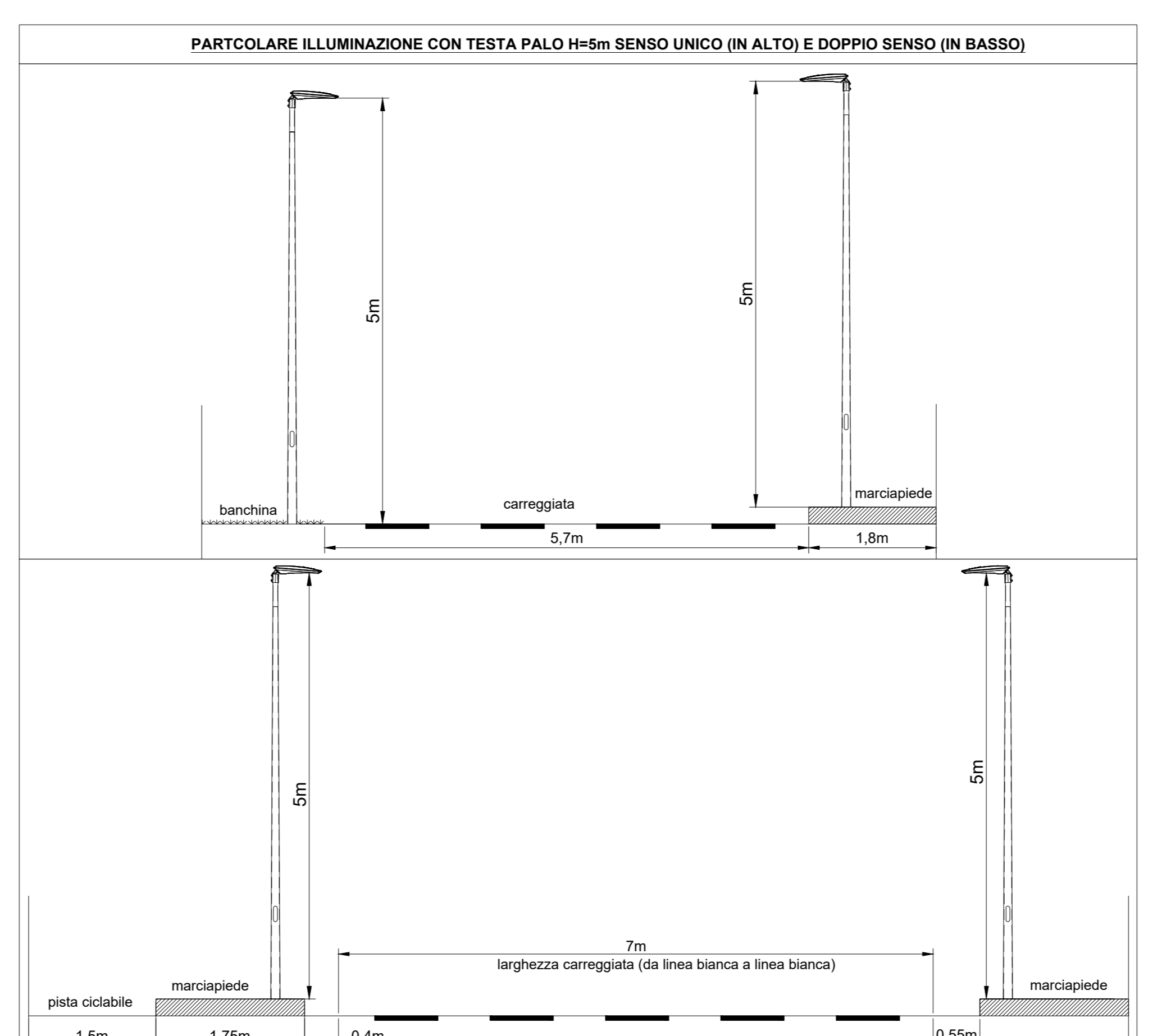
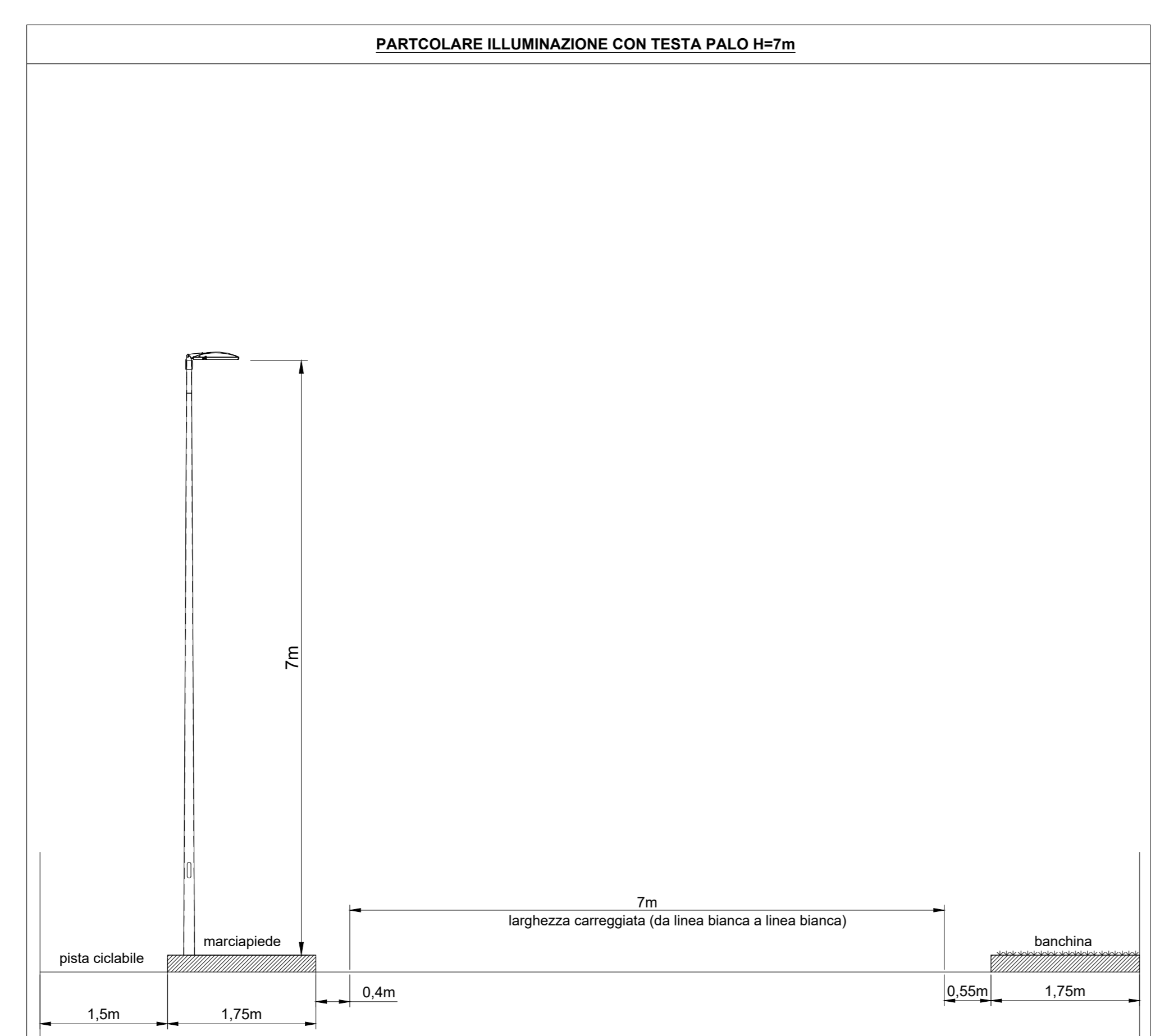
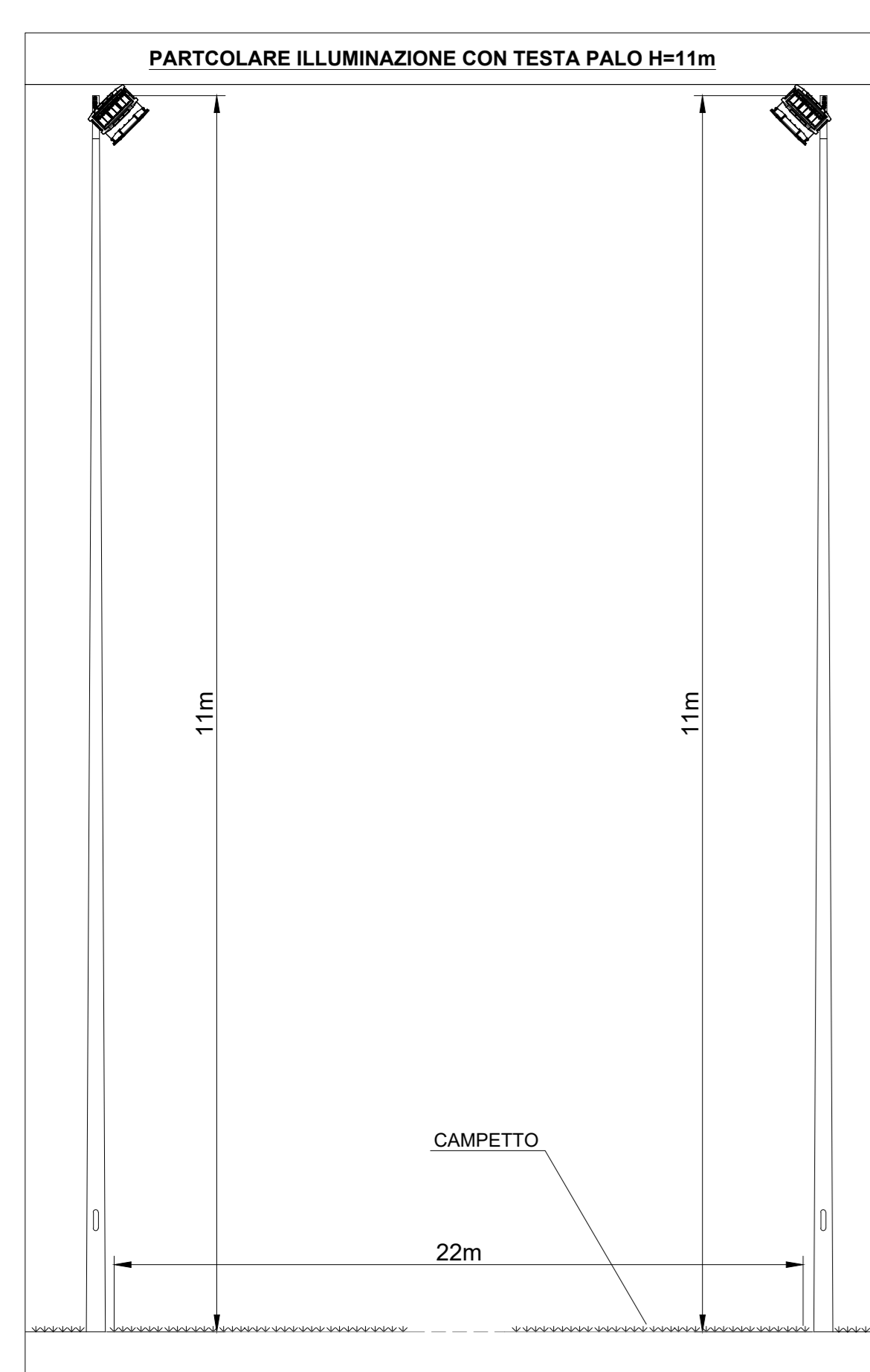

COMUNE DI VENEZIA
Città Metropolitana di Venezia

BRICOMAN ITALIA S.R.L.
Società a responsabilità limitata con unico socio (soggetta ad attività di direzione e coordinamento della "SIB - Società Italiana Brocage S.p.A." Sede: Roccazone, Via Guglielmo Marconi n. 24)



PROGETTO
REALIZZAZIONE DI UNA GRANDE STRUTTURA DI VENDITA TIPOLOGIA SINGOLA
Progetto definitivo per la realizzazione di un nuovo edificio commerciale tipo BRICOMAN nella zona identificata "AEV Terraglio" in Via Cesco Baseggio Mestre

PROGETTO DEFINITIVO

STRUTTURA DI PROGETTAZIONE
Progetto architettonico: Arch. Andrea Borin, Arch. Massimo Furlan
Progetto strutturale: Ing. Valentina Corras, Ing. Antonio Alessandrini
Progetto impiantistico: Ing. Antonio Alessandrini, Arch. Massimo Furlan
Collaboratori: Arch. A. Civian, Arch. V. Coraggio, P.E. F. Farnesello, Ing. A. Longo, Ing. V. Iacob

Consulenti esterni: Impianti A&S Engineering, Adhonor Studio Associato, Alberto Decidi
Acustica: G.L. Tinarello Antonio
Ambientale: Dr. Edo. Giampiero Malvasi



TITOLO
IMPIANTO DI ILLUMINAZIONE ESTERNA AREE IN CESSIONE AL COMUNE

LABORATO
RPI

REVISIONE	DATA	OGGETTO	REDAITTO	VERIFICATO	APPROVATO	SCALA
01	11/10/2022	Primo intervento	A. Decidi	M. Furlan	M. Furlan	1:400
02	28/04/2023	Secondo intervento	A. Decidi	M. Furlan	M. Furlan	1:400
03						
04						

NOTE FILE: 220204-001-001

LEGENDA

- PUNTI LUCE PER ILLUMINAZIONE INSEGNA H 13,5m
- PUNTO LUCE TESTA PALO H 8m TIPO 1 (vedi particolare)
- PUNTO LUCE TESTA PALO H 8m TIPO 2 (vedi particolare)
- PUNTO LUCE A PARETE H 9m (vedi particolare)
- PUNTO DI SOSTEGNO PER PALI DI ILLUMINAZIONE CON POZZETTO INCORPORATO PER ILLUMINAZIONE STRADALE
- TUBAZIONE IN PVC CORRUGATO DOPPIA PARETE Ø110

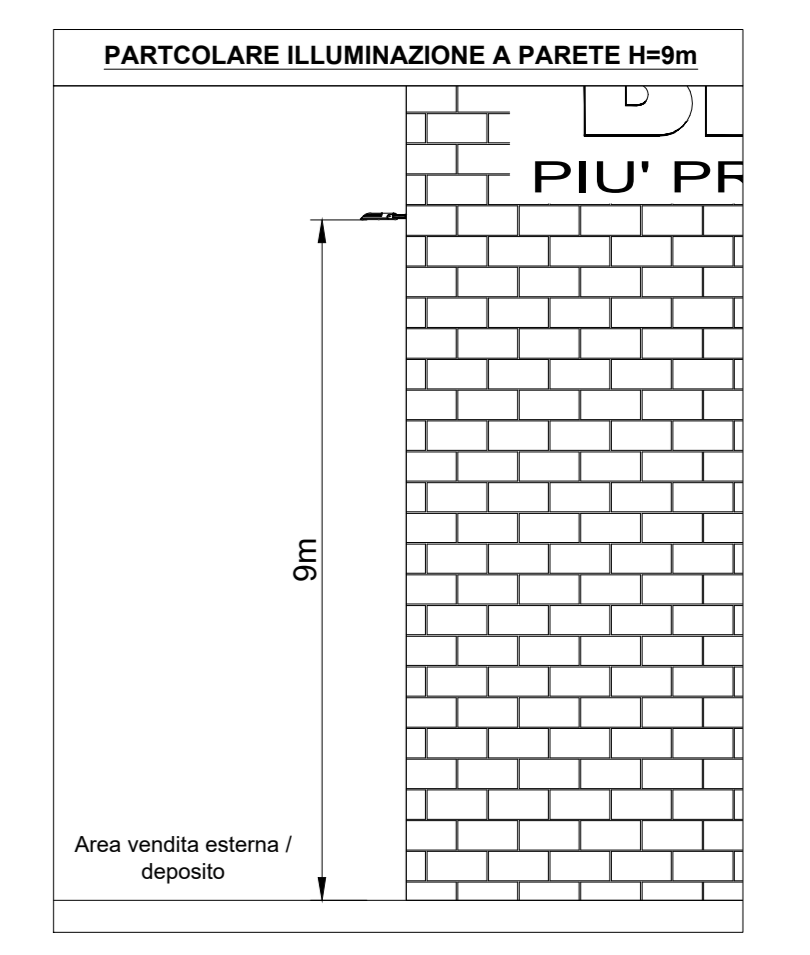
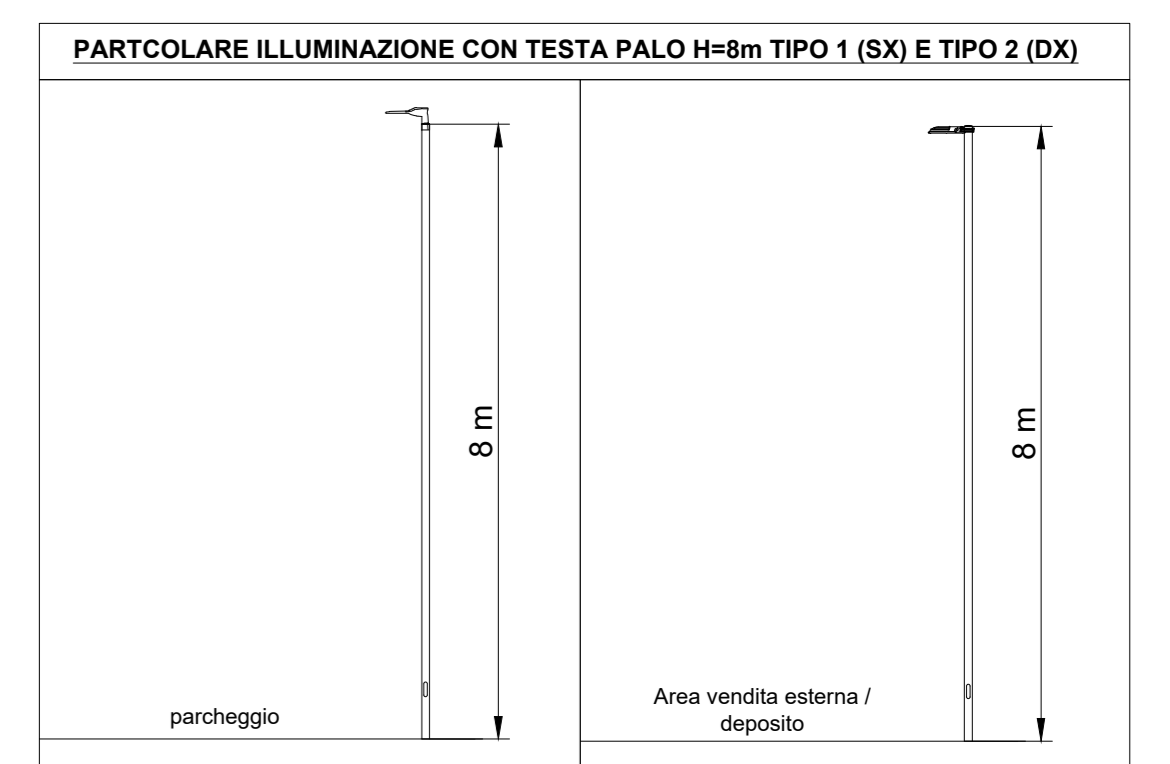
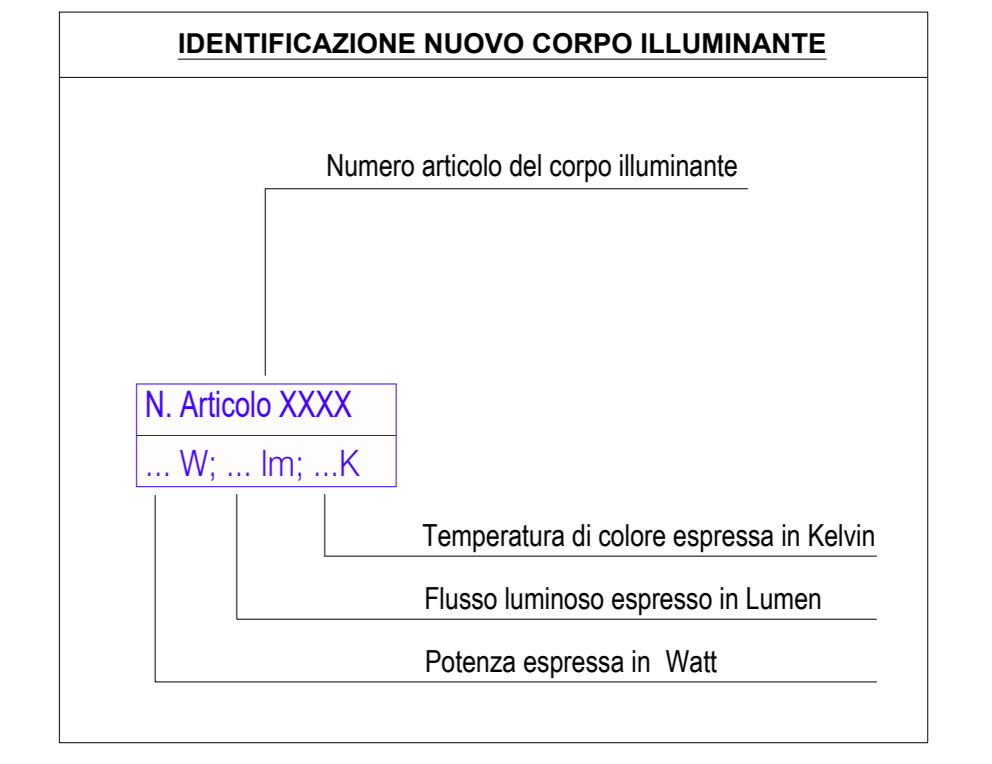

COMUNE DI VENEZIA
Città Metropolitana di Venezia

BRICOMAN ITALIA S.R.L.
Società a responsabilità limitata con unico socio (soggetta ad attività di direzione e coordinamento della "SIB" - Società Italiana Brocage S.p.A. - Sede: Roccazone, Via Guglielmo Marconi n. 24)



PROGETTO
REALIZZAZIONE DI UNA GRANDE STRUTTURA DI VENDITA TIPOLOGIA SINGOLA
Progetto definitivo per la realizzazione di un nuovo edificio commerciale tipo BRICOMAN nella zona identificata "AEV Terraglio" in Via Cesco Baseggio Mestre

PROGETTO DEFINITIVO

STRUTTURA DI PROGETTAZIONE
 Progetto architettonico: Arch. Andrea Bordin, Arch. Massimo Furian
 Progetto strutturale: Ing. Valentina Coras
 Progetto impianti: Ing. Antonio Alessandrini, Arch. Massimo Furian
 Collaboratori: Arch. A. Cissan, Arch. V. Coras, P. F. F. F. F., Ing. A. Longhi, Ing. V. Isob

Consulenti esterni:
 Impianti: A&S Engineering, Advisor Studio Associato, Alberto Deodati
 Acustica: G. Trivellato, Antonio
 Ambientale: Dr. E. Giampiero Malvasi



TITOLO
IMPIANTO DI ILLUMINAZIONE ESTERNA AREE DI PROPRIETA' BRICOMAN

ALABRATO
RPI

REVISIONE	DATA	OGGETTO	REDAATTO	VERIFICATO	APPROVATO	SCALA
01	11/11/2022	Primo incarico	A. Deodati	M. Furian	M. Furian	1:200
02	26/04/2023	Seconda incarico	A. Deodati	M. Furian	M. Furian	1:200
03						1:200
04						1:200

NOTE: FILE 20230408-001

ESTERNI
SCALA 1:200

